

Wireless World

RADIO AND ELECTRONICS

MARCH
1948

37th YEAR OF PUBLICATION

Proprietors : ILIFFE & SONS LTD
Managing Editor : HUGH S. POCKOCK, M.I.E.E.
Editor : H. F. SMITH

Editorial, Advertising and Publishing Offices :
DORSET HOUSE, STAMFORD STREET,
LONDON, S.E.1.

Telephone : Wate-loo 3333 (60 lines).
Telegrams : "Ethaworld, Sedist, London."

PUBLISHED MONTHLY
Price : 1/6

(Publication date 26th of preceding month)

Subscription Rate : 20/- per annum. Home and
Abroad

Branch Offices :

Birmingham : King Edward House, New Street, 2.
Coventry : 8-10, Corporation Street.
Glasgow : 26B, Renfield Street, C.2.
Manchester : 260, Deansgate, 3.

In this Issue

| | |
|---|-----|
| EDITORIAL COMMENT | 79 |
| BRITISH SUB-MINIATURE VALVES | 80 |
| SINGLE-VALVE A. F. OSCILLATOR By K. C. Johnson | 82 |
| PUSH-PULL INPUT CIRCUITS—3 By W. T. Cocking | 85 |
| INDUSTRIAL ELECTRONIC APPARATUS By D. W. Thomasson | 88 |
| BOOK REVIEWS | 92 |
| MULTI-CHANNEL COMMUNICATION SYSTEM | 93 |
| TEST REPORT : EKCO MODEL A52 | 94 |
| DOES DISTORTION MATTER ? | 97 |
| MANUFACTURERS' PRODUCTS | 99 |
| WORLD OF WIRELESS | 100 |
| F. M. RECEPTION By D. Maurice and R. J. H. Slaughter | 103 |
| LOAD By "Cathode Ray" | 107 |
| SOCIETIES AND CLUBS | 109 |
| LETTERS TO THE EDITOR | 111 |
| UNBIASED By "Free Grid" | 114 |
| SHORT-WAVE CONDITIONS By T. W. Bennington | 115 |
| RANDOM RADIATIONS By "Diallist" | 116 |
| RECENT INVENTIONS | 118 |

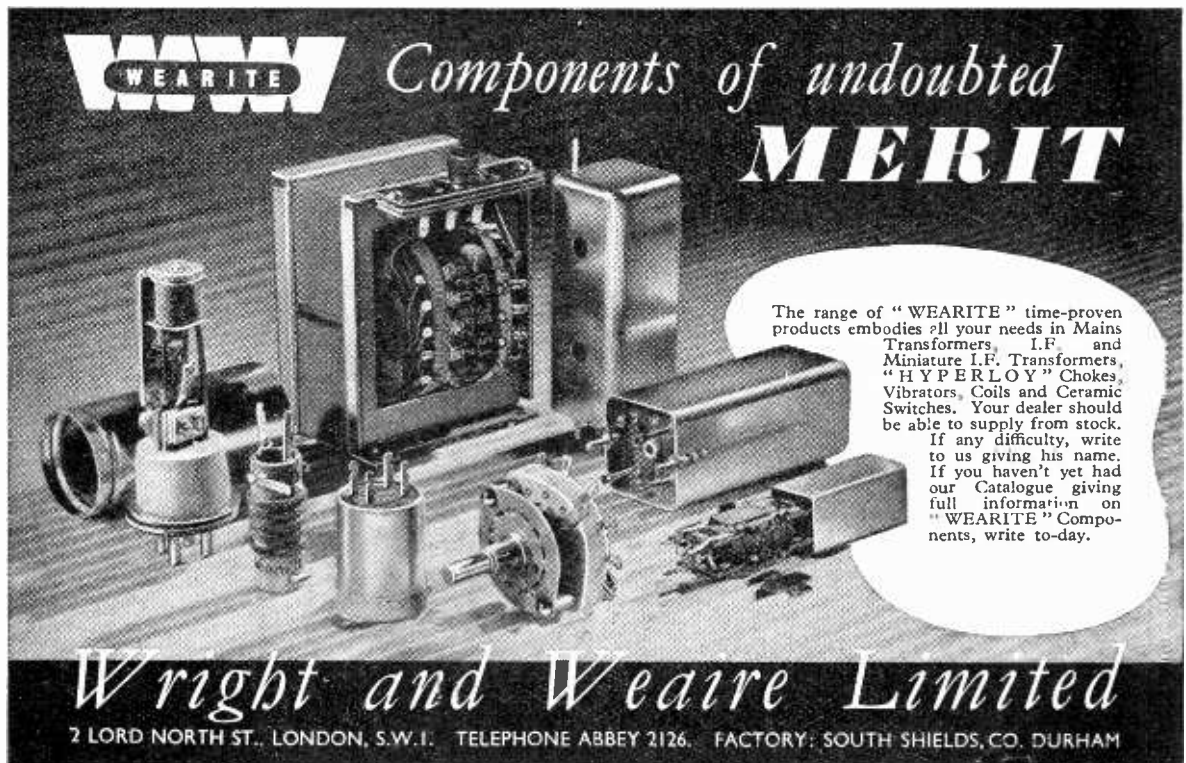

WEARITE Components of undoubted **MERIT**

The range of "WEARITE" time-proven products embodies all your needs in Mains Transformers, I.F. and Miniature I.F. Transformers, "HYPERLOY" Chokes, Vibrators, Coils and Ceramic Switches. Your dealer should be able to supply from stock. If any difficulty, write to us giving his name. If you haven't yet had our Catalogue giving full information on "WEARITE" Components, write to-day.

Wright and Weaire Limited
7 LORD NORTH ST. LONDON, S.W.1. TELEPHONE ABBEY 2126. FACTORY: SOUTH SHIELDS, CO. DURHAM



VALVES AND THEIR APPLICATIONS

By M. G. SCROGGIE, B.Sc., M.I.E.E.

No. 15: Mullard System of Type Nomenclature for Receiving Valves

EXCEPT to the abnormal mind that can do things like memorizing the Telephone Directory, valve type numbers no doubt seem too numerous, complicated and unintelligible to be worth the effort of studying. Many different systems of nomenclature have been used from time to time, and I suppose it is generally realized that most of them convey to the initiated some information about the valves so named. A system has been in use for Mullard receiving valves for the last nine or ten years, and some of the names — such as EF50 — are now very well known; yet I wonder how many who are familiar with them know what they mean. Although it is perhaps less obvious than usual that they mean anything at all, they do in fact tell one most of the things one wants to know at the outset, without being cumbersome or hard to remember.

Take the EF50. This name indicates that the valve is a voltage-amplifying pentode with a 6.3V heater, on a B9G base, and is the earliest Mullard type of that description. So far as I am aware there is no such valve as a DBL33 in existence or contemplated, but if it did appear, anyone with the key would know it was a double-diode-output pentode with a 1.4V filament, on an octal base; the third of that kind to be developed.

There is much to be said for this scheme, which is set out below, but there is only space just now to point out one or two things about the system. All valves which differ only in the final figure of their names are of the same general type and have the same base and heater or filament. The last figure enables them to be placed in order of appearance. If one is interested only in valves of a particular heater voltage or current, then all those whose names begin with a letter other than the selected one can be ignored. Similarly, the first figure enables all valves fitted with a particular base to be picked out. The second letter indicates the electrode structure and general characteristics or purpose. A third letter is used to define an additional electrode structure in the same bulb.

Many valve users are concerned with only one

or perhaps two heater ratings and bases, so have little to remember beyond the second-letter list.

It is important to note that the system does not cover valves on the British 4, 5 and 7 pin bases, and applies only partially to the side contact valves and to one or two early television types.

KEY

FIRST LETTER Filament (f) or Heater (h).

| | |
|--------------|--------------|
| A 4V f or h. | G 5V f or h. |
| C 0.2A h. | K 2V f. |
| D 1.4V f. | P 0.3A h. |
| E 6.3V h. | U 0.1A h. |

SECOND LETTER (and third if necessary):
Electrode Structure.

| | |
|-------------------------------|-------------------------------|
| A Single diode. | L Output pentode. |
| B Double diode. | M Electron beam indicator. |
| C Triode. | N Gas triode. |
| D Output triode. | *P Secondary emission valve. |
| E Tetrode. | W Half-wave gas rectifier. |
| F Voltage amplifying pentode. | X Full-wave gas rectifier. |
| H Hexode. | Y Half-wave vacuum rectifier. |
| K Heptode or octode. | Z Full-wave vacuum rectifier. |

* As a third letter only.

FIRST FIGURE (Base).

| | |
|-----------------|-------------------|
| 2 B8G (Loctal). | 5 B9G or special. |
| 3 Octal. | 7 Sub-miniature. |
| 4 B8A. | 9 B7G. |

SECOND FIGURE (and third if necessary):
Development Number.



This is the fifteenth of a series written by M. G. Scroggie, B.Sc., M.I.E.E., the well-known Consulting Radio Engineer. Reprints for schools and technical colleges may be obtained free of charge from the address below. Technical Data Sheets on all types of valves are also available.

**THE MULLARD WIRELESS SERVICE CO. LTD.,
TECHNICAL PUBLICATIONS DEPARTMENT,
CENTURY HOUSE, SHAFESBURY AVE., WC2.**

Wireless World

RADIO AND ELECTRONICS

Vol. LIV. No. 3

March 1948

Comments of the Month

A COPY of the "Final Acts" of the Atlantic City International Conferences has now reached us. This bulky volume, which, in the French-English text, runs to well over 1,000 pages, bears witness to the extent to which radio—and the organization needed for its international regulation—has grown since its predecessor was issued. The book is divided into three sections: International Telecommunication Convention; Radio Regulations and, lastly, Recommendations and Resolutions adopted by the Radio Conference. Of these, the Regulations, which contain the frequency allocation tables for the various services, are by far the most important to the majority of wireless men. The information contained in this section is essential to anyone concerned with the international aspects of radio, and is also of great importance to all serious students of the subject.

At the last conference, held in 1938, the upper limit of allocated frequencies was 200 Mc/s; at Atlantic City this figure was raised to 10,500 Mc/s. As has already been reported, the most drastic changes were in the H.F. bands with world-wide range, over which rigid control and complete international agreement are essential. Allocation of the higher frequencies (mainly with a limited visual range) can be made on a more local basis, except that full international uniformity is needed for a limited number of services such as those providing aids for sea and air navigation.

It is a matter for self-congratulation among wireless men that so much was achieved at Atlantic City. In this post-war world, bedevilled as it is by international jealousies and the conflict of rival ideologies, it is something of an achievement to have secured complete acceptance of the frequency allocation plan. In spite of this success, the "Final Acts" bear many marks of the times, in the shape of reservations and the acceptance of "official" languages with no real international currency.

An important outcome of the conference is the

setting up of an International Frequency Registration Board, endowed with as much international authority as one can expect in the present state of the world to approve and "register" frequencies for individual services. This is a real improvement over the former system of legalized "squatting."

It is understood that no arrangements have yet been made to print the "Final Acts," or even the "Radio Regulations" section of it, for distribution in this country. But, as the book is of great value to a section—though perhaps a limited one—of the radio public, it is to be hoped that it will eventually be obtainable here.

FUTURE OF RADIOLYMPIA.—Approval of the Radio Industry Council's decision that no National Radio Exhibition shall be held this year will inevitably be tinged with some regrets. The reason given—to allow the industry to concentrate without distractions on the achievement of its export target—is valid, but on the other hand, the exhibition of last year was a resounding success, and it undoubtedly did more than any other event to re-establish the prestige of British radio abroad.

That prestige had suffered severely as a result of the ill-conceived decision to postpone detailed publication of British wartime developments until virtually the full story had been told elsewhere—notably in America. *Wireless World's* strictures against this deplorable policy proved to be well justified; when the story was disclosed at the Radar Convention in 1946 it had no "news value" and was virtually ignored by the technical Press of the whole world. Radiolympia, 1947, went a long way towards showing that British radio is still very much worthy of notice in technical circles everywhere, and the good results of it are still to be seen. Now that there is to be no 1948 show to keep that idea alive, those responsible for authorizing publication of developments should shake off the remaining traces of wartime "security-mindedness" that are still sometimes evident.

British Sub-miniature Valves



NEW MULLARD SERIES

WITH 25 mA FILAMENTS

IN the past, the market for sub-miniature valves has been largely dominated by American manufacturers. These extremely small valves have found wide application in hearing-aid equipment in which compactness, light weight, and low power drain are the generally accepted design criteria.

Further progress in this field is marked by a new series of Mullard

valves represent a notable advance in manufacturing technique, and open up wide fields of possibility to the designer of miniature electronic equipment.

The low filament current has been obtained through the use of oxide-coated tungsten filaments of extremely small diameter. The use of such filaments has been made possible by research into the properties

of tungsten, and special techniques have been evolved for maintaining the purity and homogeneity of this material during the initial processes. In addition, a special all-glass valve sealing technique has been developed which prevents damage to these extremely fine filaments due to the high temperatures normally encountered in glass sealing processes.

The electrode structure is remarkable for the ease with which it can be assembled. In spite of the extremely small dimensions of the valve, the major assembling operations may, in fact, be performed by relatively untrained women, the more precise and delicate welding operations being reserved for a comparatively few highly skilled operators. As a result of this development in manufacturing technique, it is now possible to produce these extremely small valves by efficient mass-production methods.

Reference to Fig. 1 will show that the electrode structure is assembled between a pair of mica discs which are held in position by two support wires. The alignment of the electrodes during assembly is determined almost entirely by precisely positioned holes in the micas. Additional rigidity is imparted to the whole structure by the anode which is firmly located in the top and bottom mica discs and is welded to the two main support wires.

Fig 1. Constructional details of Mullard sub-miniature valves, and base connections viewed from below.

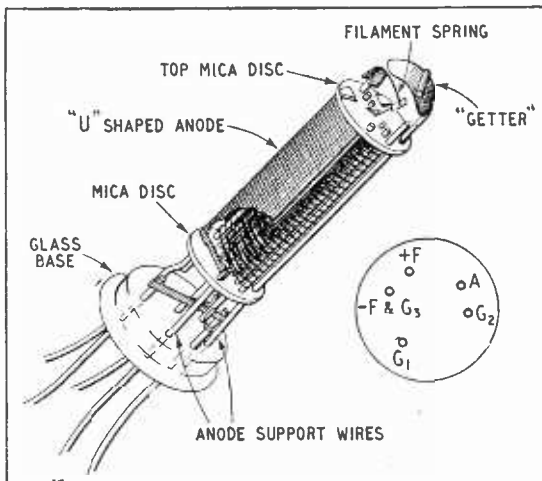

sub-miniature valves which are characterized by an extremely low filament current. Developed in collaboration with the Post Office Research Station for use in the Government-sponsored hearing aid described in the January issue of *Wireless World*, these

valves represent a notable advance in manufacturing technique, and open up wide fields of possibility to the designer of miniature electronic equipment.

The electrode structure is remarkable for the ease with which it can be assembled. In spite of

The filaments operate at a comparatively low temperature. As a result of this, there is a minimum loss of barium due to vaporization, and a consistent emission is maintained over long periods of operation.

Another interesting feature is the consistent gain which is maintained for decreasing filament voltages. This is illustrated in Fig. 2, which shows the gain plotted against filament voltage for a DL71 output pentode used in the national hearing aid circuit. It will be seen from this that when the filament voltage is reduced to its normal limit of 1.1 a consistent gain is maintained, and that even when the voltage is as low as, 0.9, the reduction in gain is small. This means that in an amplifier circuit employing these new valves it is possible to obtain a high order of performance over the maximum useful life of the L.T. cell, a feature of con-

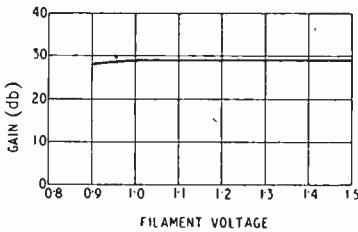

Fig. 2. Gain is practically independent of filament voltage over a wide range.

siderable importance in equipment such as hearing aids and similar miniature electronic equipment.

Three sub-miniature valves are at present being manufactured, a voltage-amplifying pentode DF70, and two output pentodes, DL71 and DL72. They are of the 10-mm (0.4 in) cylindrical type, the lengths being 30 mm (1.18 in) for the DF70 and 38 mm (1.5 in) for the DL71 and DL72 output pentodes. These valves compare favourably in size with corresponding sub-miniature valves of American manufacture, whilst having the advantage over the latter of a lower filament current for equal performance. This advance has been achieved without introducing any loss in the robustness and rigidity of the electrode structure, and these valves are characterized by a marked re-

sistance to mechanical shock, and freedom from microphony. The lead-out wires are tinned to facilitate direct soldered connection into the circuit.

The hearing-aid circuit for which these valves were developed employs two voltage-amplifying pentodes DF70 followed by either a DL71 or DL72 output

The principal characteristics of the DL71 output pentode are shown in Fig. 3 and the operating

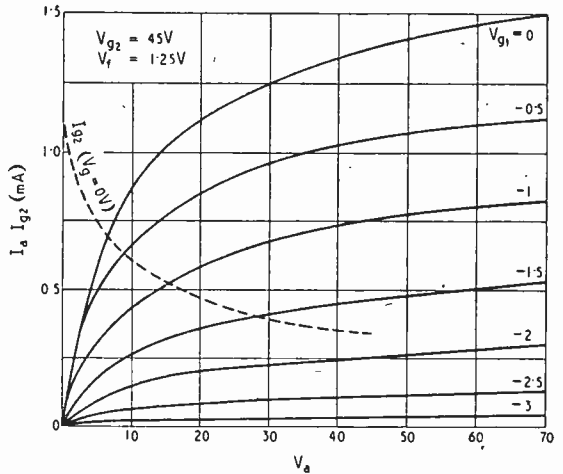

Fig. 3. Characteristic curves of the DL71 output pentode.

pentode, depending upon whether the circuit is for use with a crystal or magnetic-type ear-piece. The 0.625-volt filaments of the DF70 valves are connected in series and are fed, together with the 1.25-volt filament of the output pentode, from a dry cell. The total current taken by such a filament circuit is no more than 50 mA at an average of 1.25 volts, whilst the total power consumed by the unit is normally less than 1/8th watt. The filament current taken by a similar circuit employing equivalent valves of American manufacture is 75 mA. In this

data of the valves are given in the table below. The limiting voltages for the anodes and screen grids of all three valves is 45 volts maximum.

It is yet too early to envisage the effect that this major development in valve-manufacturing technique will have on the future design of miniature electronic equipment. For some time it is to be expected that their use will be confined to hearing-aid circuits. However, as the supply position is improved and further experiments are conducted on the performance and characteristics of

| | DF70 Voltage Amplifying Pentode | DL71 Output Pentode | DL72 Output Pentode |
|---------------------------------------|--|---------------------------------|--------------------------------|
| V _f | 0.625V | 1.25V | 1.25V |
| I _f | 25 mA | 25 mA | 25 mA |
| V _a | 30V | 45V | 45V |
| V _{g2} | 30V | 45V | 45V |
| V _{g1} | 0 | -1.25V | -4.5V |
| I _a | 0.375 mA | 0.6 mA | 1.25 mA |
| I _{g2} | 0.125 mA | 0.15 mA | 0.4 mA |
| G _{in} | 0.22 mA/V | 0.55 mA/V | 0.5 mA/V |
| Voltage gain R _a = 1MΩ | 35 | — | — |
| R _{g2} = 3MΩ | — | 6mW | 23mW |
| Power output for 10% total distortion | — | (R _a = 100,000 ohms) | (R _a = 30,000 ohms) |

application, therefore, the use of these new British sub-miniatures results in a reduction in filament current of over 30 per cent.

these valves, it may well be that they will lay the foundation of a new era in the design of small, low-power electronic units.

THERE are countless uses for a good audio-frequency oscillator in every field from simple fault-finding to pure research, and very many designs have been proposed at different times. Almost all of these employ either the beat-frequency principle or resistance-capacity phase-shift networks, since tuned circuits in the audible range are impracticable and simple oscillators cannot be used. The beat-frequency arrangement has the advantage that a wide frequency range can easily be obtained, but it has very

Single-valve A.F.

Simple R-C Circuit Covering 35 to 16,000 c/s

The basic circuit arrangement used is shown in Fig. 1, and it will be seen that this may be conveniently divided into two parts

The relationship may be expressed:

$$f_0^2 = \left(\frac{1}{4\pi^2 R_1 C_1 C_3} \right) \frac{1}{R_3}$$

The frequency is thus approximately proportional to the inverse square root of the resistance R_3 , but when R_3 is very small the approximations break down and the frequency rises to a definite limit. With an ordinary volume control for R_3 it is possible to get frequency ranges of at least 23:1, as the control covers a useful range of over 500:1 in resistance, and so two ranges can be made to cover the whole audible band. Since the relation between frequency and resistance is a simple power law, it can be shown that an accurately logarithmic potentiometer will give a logarithmic frequency range, and an ordinary volume control gives a good approximation to a log range, if it is wired so that the lowest frequency comes at the high-volume end and the taper spreads out the high frequencies.

Maintaining Amplifier. — The amplifier circuit, to maintain the oscillations, is required to give a gain just greater than unity without phase-inversion, and to be as free as possible from phase-

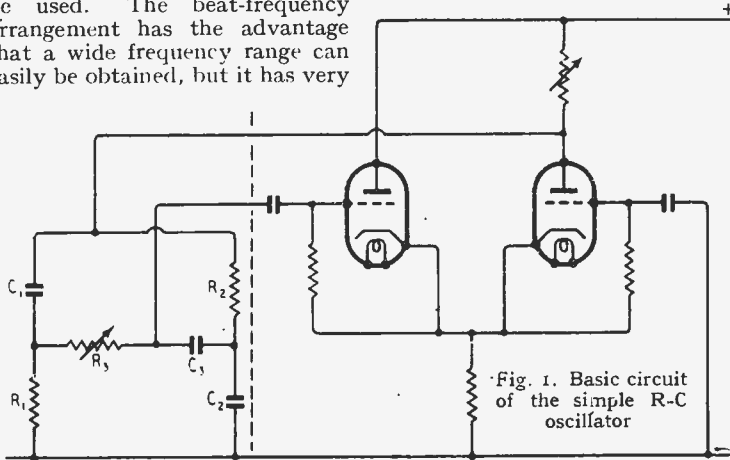

Fig. 1. Basic circuit of the simple R-C oscillator

poor stability, unless elaborate and costly precautions are taken, particularly at the lowest frequencies where "pulling-in" may occur. R-C oscillators can be made to give better waveforms and amplitude stability, and for these reasons they are now generally preferred. The majority of R-C oscillator designs that have been published, however, are rather complicated and require either careful adjustments or the use of components which are not readily obtainable. Most circuits using the Wien Bridge network, for instance, call for ganged resistors, and special low-current bulbs are generally used to limit the amplitude. As a result of these complications most experimenters and servicemen have not been able to make these circuits up themselves.

The circuit described in this article is designed to overcome these objections by using a modified "parallel-T" type of network and an amplifier which automatically limits the amplitude of oscillation. It is possible to build a practical single-valve oscillator using comparatively few components to cover nearly the whole of the audible range.

which will be considered separately in detail.

Phase-Shift Network. — The phase-shift network used is shown basically in Fig. 1, and it will be seen that it has a single frequency-control resistance R_3 . The components R_1 and R_2 are made roughly equal, as also are C_1 and C_2 , but there is no need to use accurately matched pairs. Also the impedance of each step in the network is made so that the previous step is not noticeably loaded, and R_1 and C_1 are chosen to have about equal impedance in the centre of the frequency range, as also are R_3 and C_3 . Under these conditions it is not difficult to show by a vector analysis that there is a critical frequency f_0 where the phase-shift and attenuation are both zero.

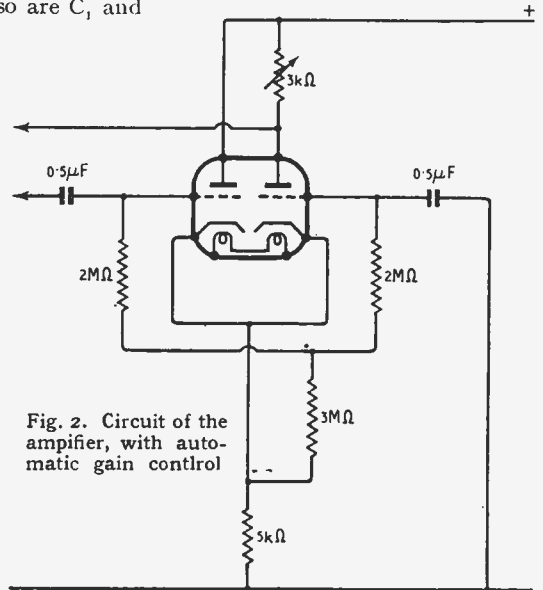

Fig. 2. Circuit of the amplifier, with automatic gain control

Oscillator

By K. C. JOHNSON

in Two Ranges

shift at all the frequencies covered. It is also required to have a high input and low output impedance, so as not to upset the R-C network, and lastly, it must provide a practically distortionless reduction of gain to limit the amplitude of the oscillations. The circuit which has been evolved, and which is shown in Fig. 2, fulfills all these conditions without using any unusual components.

usual way, but in order to reduce the phase distortion and assist the symmetry of the two stages, most of the leak is made common to both grids. It must be remembered that this arrangement has a long time-constant, and several seconds are required for it to charge up when the oscillator is switched on, so that oscillations do not start as soon as the valve is warmed up.

It is essential that the H.T. supply to the amplifier should be as free as possible from 50- or 100-

should not serve as the conditions are not critical, but it may be necessary to alter some of the component values to get best results. Since the valve may accidentally be "on" with the oscillator not running and no grid bias it should be arranged that the anode current can never seriously exceed the maximum value. This is not difficult as a large smoothing resistance is required in any case to remove ripple.

The range-switching system is quite conventional and Fig. 3 (a) shows the arrangement for a logarithmic frequency control. It is often more convenient, how-

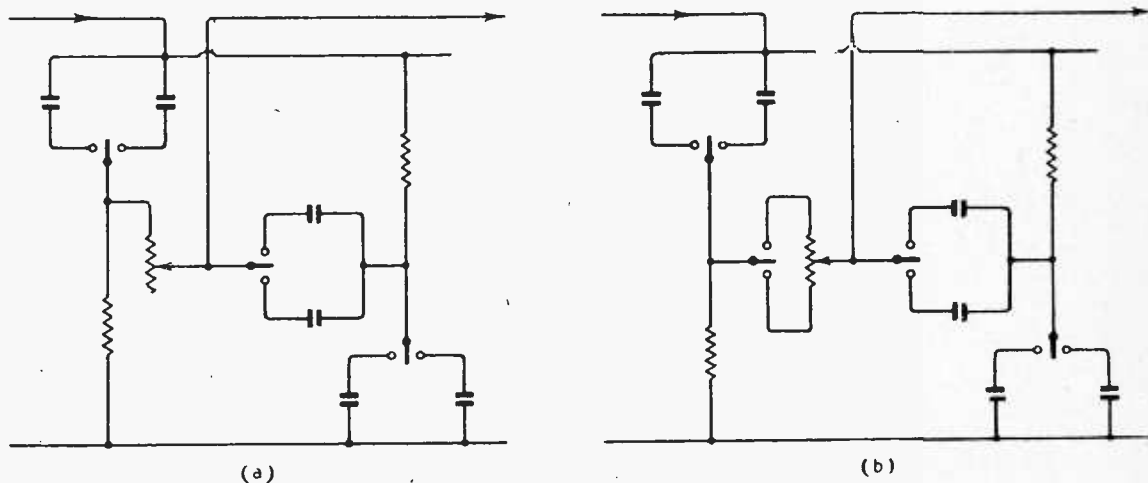

Fig. 3. Switching circuits for the network ; (a) for a log control, (b) for continuous coverage.

A double triode is used in the circuit shown as a two-stage amplifier with cathode coupling. In this arrangement the grid swings of the two valves are very nearly equal and opposite, so that even with the small anode loading almost all the even harmonics are automatically eliminated. The small anode loads, however, mean that the I_a/E_g characteristics of each valve are not linearized and the overall slope can be reduced by the application of grid bias, without loss of overall linearity. Since the third harmonic distortion in a triode is always small and the second and fourth harmonics have been practically eliminated, this amplifier is very free from distortion even though it also has variable gain.

The bias, which serves to reduce the gain, is obtained with a grid leak and condenser in the

cycle ripple, and generous smoothing is necessary to remove it. This is because the oscillator behaves as a series-tuned circuit of high Q, and a small hum ripple can build up to a very large amplitude in the output when the oscillator is tuned close to its frequency. For the same reason it is advisable to take care to prevent hum being induced into the high-impedance grid leads, by using the valve pin farther from the heater in a double triode, by arranging the switching so that there is a minimum of wiring at the high impedance, and, of course, by screening the leads and components.

Practical Circuit. — The valve used is a 6SN7 double triode which gives satisfactory results with the component values shown. There is no reason, however, why any pair of triodes

ever, to have a continuous coverage of the band without a break, so as to sweep an amplifier for resonances or dead spots, and this is provided by the second switching circuit, Fig. 3 (b), which can be arranged to give ascending frequency with a clockwise movement of the control on one range and anti-clockwise on the other. With this second circuit a linear control should be used to make the law the same on either band, but the high-frequency end of each range will be cramped.

The output from the oscillator is taken from the anode load of the second triode where the impedance is lowest and the pre-set resistance can be used to compensate for the load directly. If an audible note is required it is quite satisfactory to connect a speaker to the anode resistance through

Single-valve A.F. Oscillator—

a suitable transformer, and a useful power may be obtained without further amplification. For most purposes, however, a voltage is wanted and this may also be taken from the second anode, with a suitable attenuator and blocking condenser to isolate it from the H.T. supply.

The full circuit diagram of the finished instrument is then shown in Fig. 4. The pre-set gain control must be adjusted to give the minimum amplitude of oscillation, with satisfactory uniformity over all the ranges, to ensure the best waveform. This adjustment is not at all critical and is easily made with a good A.C. voltmeter. With the circuit shown the best setting gave a reading of about 3 volts R.M.S. on the lead into the R-C network, and the frequency ranges covered were then 35 to 800 and 700 to 16,000 c/s, with the amplitude constant to better than 10 per cent throughout both ranges.

Extension of Range.—It is quite possible to use this circuit for frequencies outside the audible range, provided that precautions are taken to overcome the losses, which become important. The frequency ranges, however, are not so wide, and owing to phase-shifts, the simple frequency relation no longer holds. For these reasons it is best to use ranges of 10:1 only, and it is then possible to arrange the switching so that some of the condensers are used twice on different ranges.

The method of overcoming these losses is to increase the gain of the amplifier by increasing the anode load as required for each range, as shown in Fig. 5, and this provides an adjustment for each end of each range separately. For the lowest frequen-

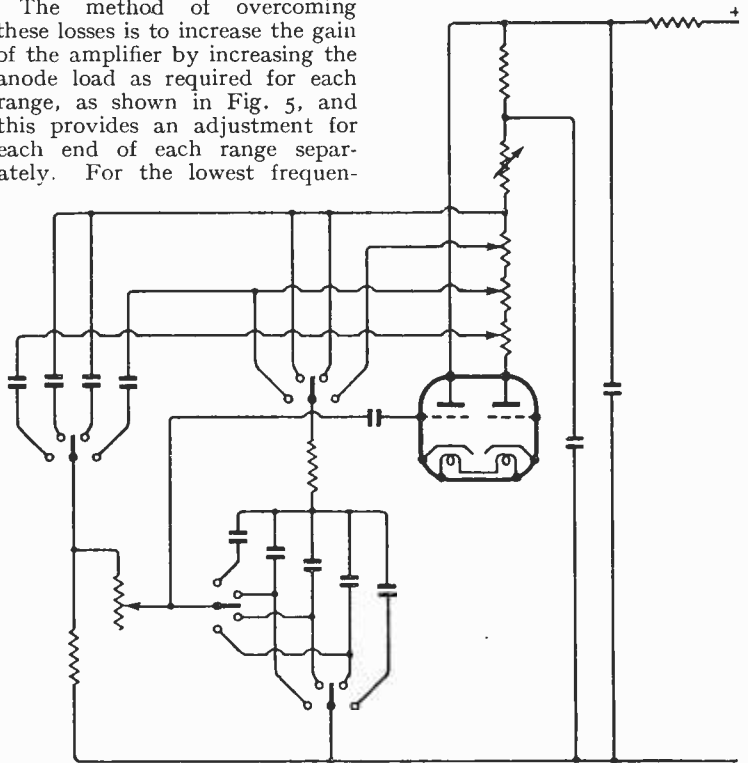

Fig. 5. Circuit for a four-range oscillator showing methods that can be used to obtain uniform amplitude and save condensers.

cies, however, it is better to increase the grid condensers, and decouple the anodes individually.

When these precautions are taken it is possible to design an oscillator covering at least from

5 c/s to 120 kc/s in four ranges, with substantial overlap, and the same good waveform and constancy of amplitude throughout.

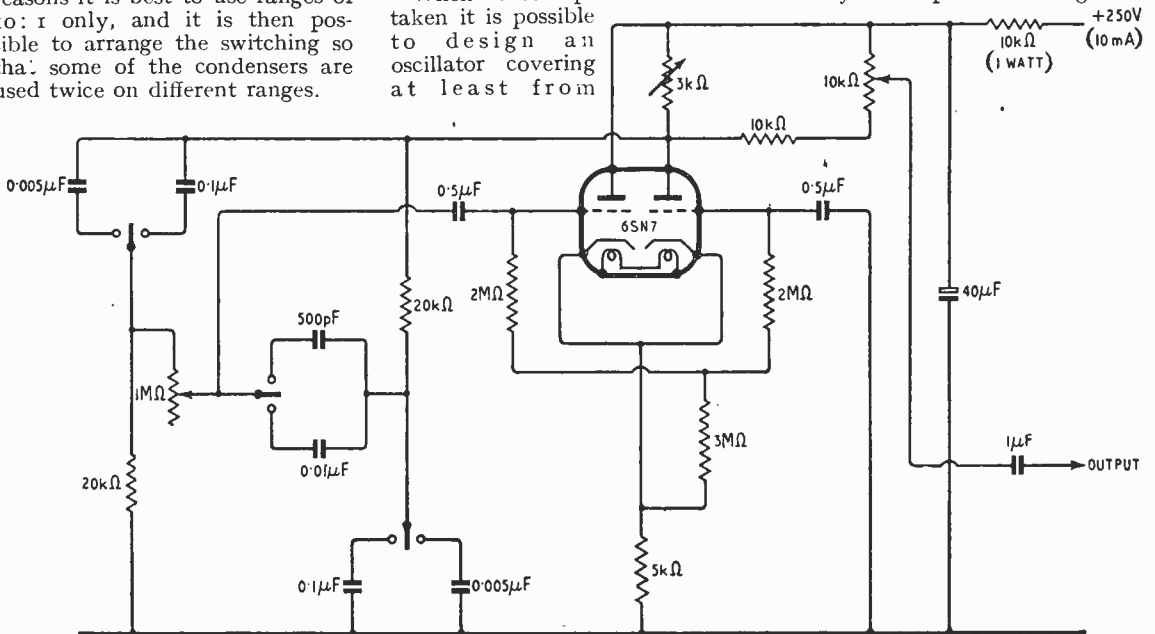

Fig. 4. Circuit diagram of oscillator covering 35 to 1,600 c/s.

Push-pull Input Circuits

Part 3—Phase Reversers

By W. T. COCKING, M.I.E.E.

THE circuits considered so far have been true phase-splitters in that they function ideally by passing a common current through two equal impedances having an earthed common point. The input voltage is used to produce two separate output voltages, one in phase with, and one in opposite phase to, the input. We now come to a class of circuits in which the input voltage and one output voltage are the same and the input is applied to a phase-reversing stage to provide the other output in opposite phase.

The so-called paraphase, see-saw and anode-follower circuits are of this type, and there are many minor variations of the basic circuits. They are usually drawn as two-valve circuits and this is inclined to be confusing for in reality one of the two valves is a pre-amplifier and takes no part in the phase reversal.

One common circuit is shown in Fig. 14; V_1 and its associated components form a normal R-C amplifier stage. One output is taken at 1,2 and is applied to one grid of the following amplifier, of which $R_1 + R_2$ forms a grid leak. V_2 is fed from a tapping on R_1, R_2 and its input E_{gc} is only a fraction of E_{12} . V_2 also functions as a normal R-C amplifier stage and its output at 3,2 is applied to the other grid of the following push-pull amplifier of which R_3 is the grid leak.

It is clear that if the loads on the two valves are equal and the valves themselves are alike, their alternating anode currents will be equal when conditions are such that $E_{12} = -E_{32}$. There will then be no alternating voltage drops across the bias resistor R_b or the decoupling capacitor C_d , and these components can be ignored in the subsequent discussion.

It is only in its effect on R_b and C_d that V_1 need be like V_2 . Apart from this there is no need for the two valves to be similar. If C_d is

large enough and if R_b is adequately by-passed the parts preceding A, B of Fig. 14 can be

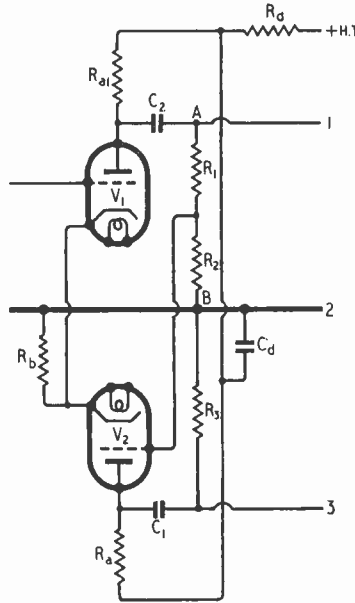

Fig. 14. The circuit of a typical phase-reverser with its pre-amplifier stage is shown here. The phase-reverser V_2 is fed from a tapping on the grid leak of one of the following valves.

of any kind without in any way affecting the relation between E_{12} and E_{32} . The discussion can, therefore, be limited to that part of the circuit which follows A, B. This relevant part of the circuit is shown in Fig. 16 (a) and it has the equivalent of Fig. 17 (a) in which C_{gc} and C_{ga} are the grid-cathode and grid-anode capacitances of the valve. C_a represents the total capacitance in shunt with the output.

An alternative circuit also widely used is shown in Fig. 15. It differs from Fig. 14 in that the input to V_2 is taken from a tapping on the coupling resistance of V_1 instead of from one on the following grid leak. The relevant part of Fig. 15 can be redrawn as in Fig. 16 (b) which has the

equivalent of Fig. 17 (b) when the circuit capacitances are added.

The circuit equations are developed in Appendix III where it is shown that for both circuits the requirement for balance at frequencies for which the capacitances can be neglected is $R_2/R_1 = A - 1$ where A is the amplification of the V_2 stage. In a typical case we might have $g_m = 2\text{mA/V}$, $r_a = 15\text{k}\Omega$, $R_a = 30\text{k}\Omega$, $R_3 = 250\text{k}\Omega$, then $A = 19.2$ and $R_1/R_2 = 18.2$

With circuit (a), $R_1 + R_2$ would be $250\text{k}\Omega$ since it is a grid leak of the following stage, and so $R_2 = 13\text{k}\Omega$ and $R_1 = 237\text{k}\Omega$. With circuit (b) $R_1 + R_2$ would be $30\text{k}\Omega$ since it is the coupling resistor of the preceding stage, and so $R_2 = 1.56\text{k}\Omega$ and $R_1 = 28.44\text{k}\Omega$. It is to be noted that the values of

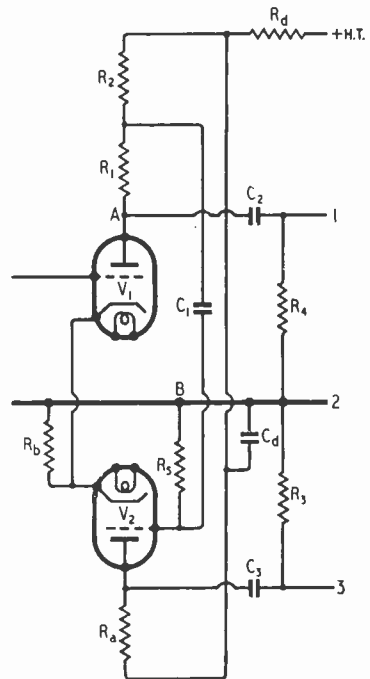

Fig. 15. This phase-reverser is similar to that of Fig. 14, but V_2 is fed from a tapping on the coupling resistance of V_1 . This improves the performance at high frequencies.

Push-pull Input Circuits—

R_1 and R_2 are critically dependent on A which is itself very dependent on g_m , r_a and R_a and to a small extent on R_3 . The valve "constants" are likely to vary considerably between different specimens of the same type and they will also vary with time as the valve ages. It is, therefore, not practicable to use fixed values

as high as 12 per cent of the correct output.

The error is very serious and can be reduced only by increasing C_3 , since in many cases the maximum value of R_3 is limited to about 250k Ω by the following valve.

Considering Eqn. (8a), usually $1 \gg R/R_3$ and if V_2 is to be small $\omega^2 C_3^2 R_3^2 \gg 1$, and so $V_2 \approx 1/\omega C_3 R_3$. At 50 c/s, and with

tends to be somewhat better than Fig. 14, but not very much so.

At high frequencies the response falls off for two reasons—the effect of shunt capacitance on R_a and the effect of shunt capacitance on R_2 . An expression for the unbalance is given in Eqn. (18) in the Appendix and it applies to both circuits. This expression is rather complex and it has not been

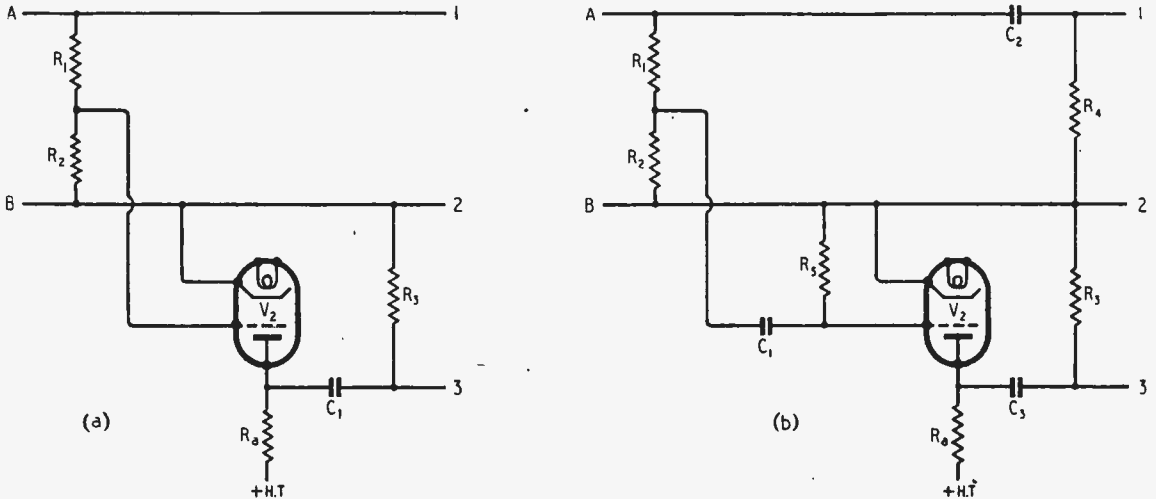

Fig. 16. The phase-reverser portions of the circuits of Figs. 14 and 15 are shown here alone at (a) and (b) respectively.

for R_1 and R_2 when a close balance is required and it is common practice to make these components wholly or partially a potentiometer with the grid of V_2 fed from its slider. This is adjusted for equality of the two outputs and requires readjustment when V_2 is replaced, and, possibly, also from time to time during the life of the valve.

At low frequencies circuit (a) is obviously imperfect because while E_{12} is still equal to E_{AB} , the other output E_{32} is passed through C_1 and its rising reactance at low frequencies must cause amplitude and phase errors. Equations (7a) and (8a) give the amplitude and phase unbalances. Taking the same values as before with $C_3 = 0.1\mu\text{F}$ at 50 c/s we find $V_1 = 0.015$ and $V_2 = 0.12$. The amplitude unbalance of 1.5 per cent is not very serious, but the quadrature unbalance of 12 per cent is much too large. It means that through the phase shifts in C_3 , R_3 the output E_{32} contains a component of voltage which is 90° out of phase with the correct output and which has an amplitude

$R_3 = 250\text{k}\Omega$ we get $V_2 = 0.0127/C_3$ with C_3 in μF . To reduce V_2 to a reasonable value around 1 per cent, C_3 must be about 1.5 μF .

It is usually undesirable to use such a large capacitance, for its capacitance to earth will be large and its leakage will almost inevitably be much lower than with a more normal value. In addition the large time constant will make the effects of any momentary overload which draws grid current in the following stage painfully evident.

The alternative circuit of Figs. 15, 16 (b) and 17 (b) has a very similar low-frequency response as shown by Eqns. (14b) and (15b). In fact, if $C_1 R_5$ of Fig. 15 equals $C_3 R_3 / (1 - R/R_3)$ of Fig. 14 the performances are identical.

However, as V_2 is usually a small triode, its grid leak can usually safely be higher than in the case of an output valve. Consequently, R_5 (Fig. 15) can often be 2M Ω , whereas R_3 (Fig. 14) must often be no more than 0.25 M Ω . This makes it easier to obtain a higher time constant and so Fig. 15

broken up into the components V_1 and V_2 since it is simpler to do this when numerical values are inserted.

As an example we shall take the previous values and assume that $C_{ga} = C_{gc} = 5\text{pF}$ and $C_a = 50\text{pF}$ and calculate the unbalance at 10,000 c/s. With these values we find $V = V_1 + V_2 = 0.013 + 0.12j$ for the circuit of Fig. 14 and $V = 0.0018 + 0.046j$ for the circuit of Fig. 15.

The amplitude unbalances are respectively 1.3 and 0.18 per cent and are small enough to be ignored for most purposes. The phase unbalances are 12 and 4.6 per cent, however.

It is thus clear that the circuit of Fig. 14 is not a good one, for the phase unbalance becomes as high as 12 per cent at 50 c/s and 10,000 c/s with normal values of components. The circuit of Fig. 15, where the feed for V_2 is taken from a tapping on the coupling resistance of V_1 instead of the following grid leak, is much better at high frequencies. The lower resistance values involved in the feed potentiometer result in some

4.6 per cent phase unbalance instead of 12 per cent.

The circuit is but little better at low frequencies, however, and neither can thus be considered to meet the requirements of a high-quality amplifier. It should be pointed out that with both circuits it is possible to reduce the phase unbalance at high frequencies by shunting R_1 by a suitable capacitance of the order of $\{C_{gc} + C_{ga}(1 + A)\} / (A - 1)$. This is a capacitance approximately equal to C_{ga} and is inconveniently small. If used it should be adjustable and set for minimum unbalance at a high frequency.

The one merit of circuits of this type over a phase-splitter is that as the valve has to provide one output only instead of two that one output can be twice as great as each of those of a phase-splitter before overloading occurs. They are in this respect more suited to driving an output stage without intermediate amplification than a phase splitter.

In addition, they have the advantage of not requiring any great difference of potential between heater and cathode.

The phase unbalance at extremes of frequency of the circuits discussed is too great to make their use desirable. These circuits are not the only ones available, however, and a phase reverser of the anode-follower type—otherwise known as the paraphase or sec-saw circuit—can have much more desirable characteristics. This will be discussed next.

APPENDIX III.

Referring to Fig. 17, at frequencies where the capacitances can be ignored,

$$E_{12} = E_{AB} \dots \dots \dots (1)$$

$$E_{32} = -E_{gc} g_m R = -E_{gc} A \dots (2)$$

where $\frac{1}{R} = \frac{1}{r_a} + \frac{1}{R_a} + \frac{1}{R_3}$ and $g_m = \frac{\mu}{r_a}$

For circuit (a)

$$E_{gc} = E_{12} \frac{R_2}{R_1 + R_2} \dots \dots \dots (3a)$$

For circuit (b)

$$E_{gc} = E_{12} \frac{R_2 R_5}{R_2 + R_5} \dots \dots \dots (3b)$$

Normally $R_5 \gg R_2$ and then

$$E_{gc} = E_{12} \frac{R_2}{R_1 + R_2} \text{ for both circuits.}$$

$$E_{32} = \frac{-E_{AB}}{\left[1 + \left(1 - \frac{R}{R_3}\right) / j\omega C_3 R_3\right] (1 + 1/j\omega C_1 R_5)} \dots \dots \dots (11b)$$

$$U = 1 - \frac{1 + 1/j\omega C_2 R_4}{1 + 1/j\omega C_1 R_5} \cdot \frac{1}{1 + (1 - R/R_3) / j\omega C_3 R_3} \dots \dots \dots (12b)$$

Therefore,

$$\frac{E_{32}}{E_{12}} = -\frac{A}{1 + R_1/R_2} \dots \dots (4)$$

and so for $E_{32}/E_{12} = -1$ we have

$$R_1/R_2 = A - 1 \dots \dots (5)$$

$$U_2 = -\frac{\omega C_1 R_5}{1 + \omega^2 C_1^2 R_5^2} \approx \frac{-1}{\omega C_1 R_5} \text{ when } 1 \ll \omega^2 C_1^2 R_5^2 \dots \dots (15b)$$

At low frequencies with circuit (a)

$$A_2 = \frac{A}{1 + \left(1 - \frac{R}{R_3}\right) / j\omega C_3 R_3} \dots (6a)$$

and so the unbalance

$$U = 1 + \frac{E_{32}}{E_{12}}$$

$$= \frac{1 - R/R_3 + j\omega C_3 R_3}{1 - R/R_3 + j\omega C_3 R_3}$$

$$= U_1 + U_2 \dots \dots \dots (7a)$$

Now $E_{32} = -E_{gc} \frac{A + j\omega C_{ga} R}{1 + j\omega(C_a + C_{ga})R} \approx -E_{gc} \frac{A}{1 + j\omega(C_a + C_{ga})R} \dots (16)$

and $E_{gc} = E_{AB} \cdot \frac{1}{A + j\omega[C_{gc} + C_{ga}(1 + A)]R_1} \dots \dots \dots (17)$

Whence $U =$

$$\frac{j\omega[C_{gc}R_1 + C_{ga}\{1 + A\}R_1 + AR] + AC_aR}{A + j\omega[C_{gc} + C_{ga}\{1 + A\}R_1 + AR] + AC_aR} - \frac{\omega^2(C_a + C_{ga})[C_{gc} + C_{ga}(1 + A)]R_1R}{\omega^2(C_a + C_{ga})[C_{gc} + C_{ga}(1 + A)]R_1R} \dots (18)$$

where the amplitude unbalance is

$$U_1 = \frac{(1 - R/R_3)^2}{(1 - R/R_3)^2 + \omega^2 C_3^2 R_3^2} \dots (8a)$$

and the quadrature component has the fractional amplitude

$$U_2 = \frac{\omega C_3 R_3 (1 - R/R_3)}{(1 - R/R_3)^2 + \omega^2 C_3^2 R_3^2} \dots (9a)$$

In the case of circuit (b)

$$E_{12} = \frac{E_{AB}}{1 + 1/j\omega C_2 R_4} \dots (10b)$$

At high frequencies in both circuits the input impedance of the valve is in shunt with R_2 . It comprises both resistive and capacitive elements and the exact expression for it is complex. However the resistive component is usually high enough in comparison with R_2 to be ignored and the capacitive component is approximately $C_{ga}(1 + A)$

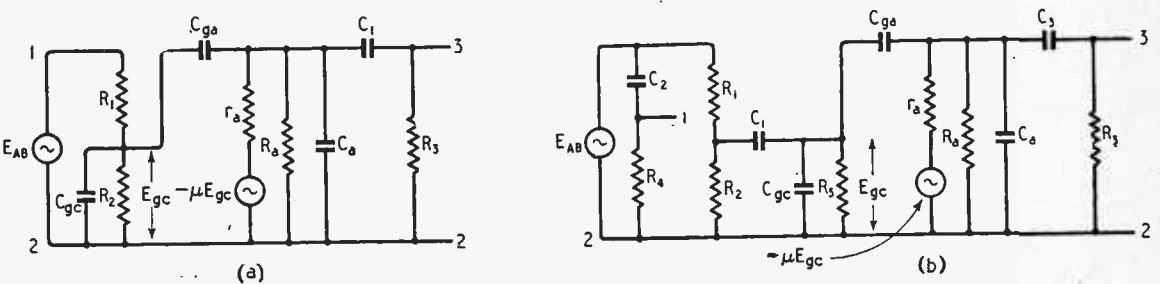

Fig. 17. At (a) and (b) are shown the equivalent circuits of Fig. 16 (a) and (b) respectively with stray capacitances added.

Industrial Electronic Apparatus

Problems of Design

By D. W. THOMASSON

THE application of electronic principles to the solution of industrial problems is not progressing as rapidly as might have been expected from the glib prophecies that have been made in the last year or two. This is not surprising, since such predictions are rarely founded on a true appreciation of the relevant facts. It is more disturbing to find that there is an actual inclination against the use of electronic methods among a number of manufacturing concerns.

This inclination is particularly noticeable in production departments. Industrial laboratories are ready to consider the advantages offered by electronic methods, and have no prejudice against them. Production departments, on the other hand, seem to have an inbred distrust of innovations, especially if they are dependent on principles of which they have little precise knowledge. It is instructive to examine the current design characteristics of electronic apparatus intended for use in production departments with a view to discovering some of the reasons for this distrust.

The reasons are not hard to find. To begin with, there is the natural outlook of the industrialist, who tends to pursue a conservative line of thought where his work is concerned. He can rarely afford to do anything else. The methods he has used for years and tried and tested, and he will

not exchange them until the alternative has been proved at least equally reliable, even if it is capable of giving better results. He is not encouraged to try electronic methods when he remembers that their essential basis is the thermionic valve, regarded for so many years as a fragile piece of apparatus. He is not particularly impressed when it is pointed out that valves have been made to

anical side, he wants robustness and solidity; he is more likely to get thin sheet metal and a bare minimum of structural strength. He is not likely to have an electronic maintenance section within his organization, and he visualizes prohibitively high costs if he has to turn to outside maintenance whenever a failure occurs.

All this, and much more, is unfortunate, but undeniably true. It might have been hoped that the exhibits at last year's Radiolympia would show a tendency to improvement, but the improvements that were to be seen could do little to outweigh the bad designs surrounding them. There is only one solution; the essential design requirements for industrial apparatus must be codified, and the requirements so determined must be met in the greatest degree possible under present difficulties. As matters stand now, there is a real danger that the present standards of design will come to be accepted as suitable even after the present restrictions eventually end.

Mechanical Design.—Industrial electronic apparatus for production purposes presents unusually severe problems from the design point of view, because the conditions under which it is required to operate are so completely different from those under which it is designed. These problems will not be solved until the designer realises that he is dealing with a piece of machinery, not a laboratory instrument. It doesn't have to look "pretty"—it has to do a job of work. There is no point in decorating the outside with gleaming coloured enamel and chromium plate. The only time when anyone is likely to sit and look at it is when it breaks down, and beauty will not help then.

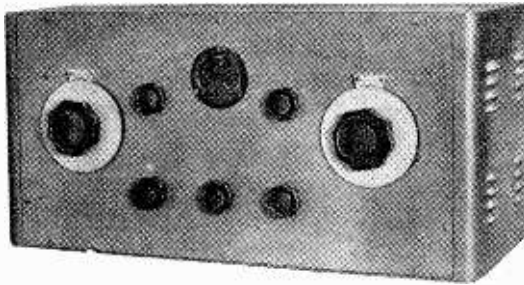

Though suitable for laboratory use, this piece of test gear would not survive long in the workshop: the panel is completely unprotected and there are no handles. The meter is too small to be read easily.

stand up to the shock of being fired from a gun, for he knows that these valves had an actual operating life of less than a minute. In any case, these valves will not be used in electronic apparatus for industry. One manufacturer is proudly advertising a control device by the statement that "normal domestic valves" are used. This will not attract a possible customer who has recently had difficulty in obtaining replacement valves for his own domestic receiver.

The industrialist's real objections begin when he examines the actual mechanical construction of the apparatus, and the complexities of many of the circuit arrangements used. On the mech-

It is quite likely that the gear will have to stand up to a fair amount of ill-treatment in use. Fragile instruments do not survive long in a workshop where heavy machinery is being made, and even in places where the product is more fragile there is always the possibility of an accident. If it involves the product, that is unfortunate, but not very serious. If it puts the machinery out of action, so that production time is lost, it is quite a different matter. Instrument cases must therefore be able to stand up to heavy treatment. The sort of case that requires a special form of packing to

ensure against its being damaged in transit is no good at all. The violence of railway porters is traditional, but they are at a disadvantage compared with the factory worker, since they are only handling the apparatus for a relatively short time. The safest rule is to allow a generous margin of safety in the strength of both the case and the chassis.

Apart from the strength of the general mechanical design, it is necessary to make the actual components and wiring of the apparatus equally robust. This requires that the individual parts be carefully selected, and that the constructional principles involved are sound. It is to be hoped that the demonstrations which were

given at Radiolympia of the effect of the frequency of small-amplitude vibrations coinciding with the resonant frequency of parts of the apparatus, will have provided a valuable object lesson to designers. This question of resonant vibration cannot be appreciated properly by anyone who has not seen the effect demonstrated. A vibration having an amplitude of

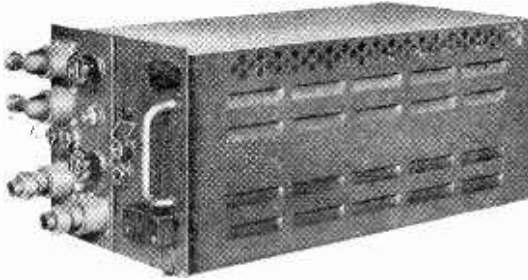

not more than 2 thousandths of an inch can induce resonant vibrations of anything up to an amplitude of half an inch or more. In apparatus which is to be used in the vicinity of heavy machinery this can result in a rapid and mysterious disintegration of the vital parts. The only way of ensuring against this in all possible cases is the use of extensive vibration damping technique, both in the suspension and general assembly. A method which is

Below is shown the same test gear removed from its case. Maximum accessibility is combined with small overall dimensions. Another lesson for designers of industrial equipment.

arousing some interest in this connection is that of sealing sections of the circuit into a mass of plastic material, so that the only possible vibration is that of the valve electrodes. Connection to the remainder of the circuit is made by a plug and socket connector, so that in the event of valve failure the whole unit can be changed.

Another scheme which is valuable in avoiding vibration effects

A wartime radar unit, showing concentration of connections on a compact panel; also strong case and good ventilation. A good model for designers of industrial gear.

is the sprayed or printed circuit. The technique has been considerably improved of recent years, and can be used to advantage in conjunction with the sealed circuit technique. In this way, the circuit can be made completely vibration-proof without causing any great difficulties for the maintenance engineer. His task is, in fact, somewhat simplified. He has only to replace the faulty section of the circuit with an identical plug-in circuit. The units can be standardized by the manufacturers, so that no re-adjustment of any sort would be required. This technique is in its infancy, but there is no doubt that it is a step in the right direction.

Valve Failures.—It is an indubitable fact that valves have a finite working life. If this life is not brought to a sudden end by a failure of the filament or heater, the emission falls off gradually

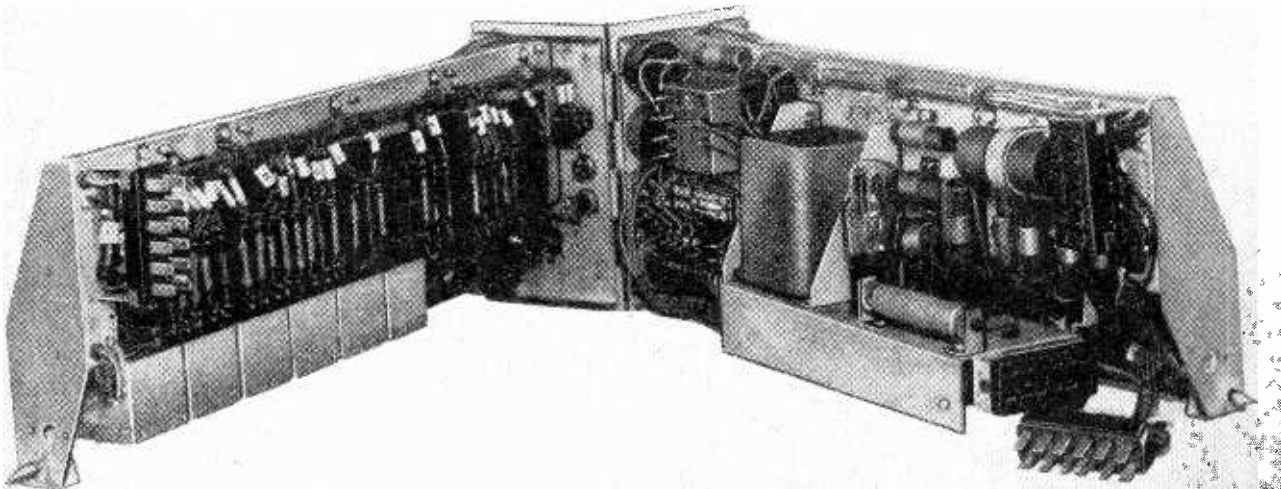

Industrial Electronic Apparatus

and the performance of the apparatus changes imperceptibly. Eventually, replacement is necessary, and the problem is to determine when this should be carried out. The safest indication in most cases is the anode current, but in many designs the measurement of this involves a major operation to gain access to the anode feed line.

The provision of a meter and switching circuit may seem a quite unwarranted expense, but the simplification of the maintenance work is a great point in favour. The meter itself may be omitted. One of the schemes used by the services during the war was the incorporation in all the more complex circuits of a system whereby a 0-1mA meter could be plugged in and used to read the current in various parts of the circuit. A switch was used to select the particular point required, and the correct readings at each setting were tabulated, together with an indication of the probable reasons for deviation from the correct values. In this way hastily trained and inexperienced workers were able to carry on with the servicing of apparatus of considerable complexity. In one case, a party of experienced radio engineers who were not in possession of the key chart spent several unsuccessful hours trying to find a fault in one of these sets, to the gratification of some nearby members of the R.A.F., who, though unskilled in

comparison, were able to locate the fault in a matter of minutes, using a copy of the key chart. Such measures may conflict with established policies, but are a tremendous help to the maintenance section of a non-technical firm.

Another point about valves replacement concerns the dependence of the circuit on the exact valve characteristics. It is not always possible to avoid this completely, and the result is that when a valve is replaced the apparatus has to be adjusted before it will operate properly.

One solution is the use of an extension of the "sealed circuit" principle to which reference has already been made in connection with vibration problems. Development work is at present in progress on the production of sealed units which include valves. Small valves may be completely sealed-in, while in the case of larger types, only the base need be within the seal. In units of this nature, the whole circuit can be adjusted to a standard performance before sealing, so that no adjustments whatsoever are required when the unit is replaced.

In cases where such circuits are not required for any other reason, however, it is usually possible to arrange for the setting to be carried out in a simple manner with a minimum of special apparatus. It might be expected that this would be done in all such cases, but there seems to be a tendency to ignore such problems as main-

tenance, perhaps out of consideration for the local service engineers. It is certainly not with the intention of assisting the customer.

Versatility and Standardization.—Up to this point the discussion has been concentrated on the finer points of design from the mechanical and maintenance points of view. These are the touches that can make or mar, but they are wasted if the basic approach is not sound. One of the most important points to be considered in this connection is the versatility of the apparatus. No two manufacturers want exactly the same thing, and it does not help to sell the equipment if they have to be told that their needs cannot be met precisely.

One of the greatest aids to versatility is standardization. This is also advantageous from the economical point of view, since it permits the production of larger quantities of identical pieces of equipment. Standardization does this in the following manner: A large instrument manufacturing company may analyse their products, and discover that two or three types of power unit would be suitable for use with perhaps forty or fifty types of equipment. They therefore manufacture only these types, modifying the equipment designs so that the power units can be fitted easily and satisfactorily into the rest of the design. They can then save a considerable amount of time and money by mass-producing the power units.

This is only one possible application of the principle. There are many other variations; the use of a standard series of valves, the use of one circuit unit in a number of different items of equipment. From the point of view of versatility, the advantage of using standardization in units and interconnections is that it is then possible to supply a large variety of different equipments without losing the advantages of mass-production economy. It becomes possible to supply the exact equipment required, instead of something that is "a little too much or a little too little." At the present time there is especial value from another aspect—the method saves material.

The question of versatility and

Books issued in conjunction with "Wireless World"

| | Net Price | By post |
|---|-----------|---------|
| TELEVISION RECEIVER CONSTRUCTION. A reprint of 10 articles from "Wireless World" | 2/6 | 2/9 |
| FOUNDATIONS OF WIRELESS. Fourth revised Edition, by M. G. Scroggie, B.Sc., M.I.E.E. | 7/6 | 7/10 |
| WIRELESS DIRECTION FINDING. By R. Keen, M.B.E., B.Eng. (Hons.), Fourth Edition | 45/- | 45/9 |
| TELEVISION RECEIVING EQUIPMENT, by W. T. Cocking, M.I.E.E., Second Edition | 12/6 | 12/11 |
| WIRELESS SERVICING MANUAL, by W. T. Cocking, M.I.E.E., Seventh Edition | 10/6 | 10/10 |
| HANDBOOK OF TECHNICAL INSTRUCTION FOR WIRELESS TELEGRAPHISTS, by H. M. Dowsett, M.I.E.E., F.Inst.P., and L. E. O. Walker, A.R.C.S., Eighth Edition | 30/- | 30/8 |
| BASIC MATHEMATICS FOR RADIO STUDENTS, by F. M. Colebrook, B.Sc., D.I.C., A.C.G.I. | 10/6 | 10/10 |
| GUIDE TO BROADCASTING STATIONS, Third Edition | 1/- | 1/1 |
| RADIO DATA CHARTS, by R. T. Beatty, M.A., B.E., D.Sc., Fourth Edition—revised by J. McG. Sowerby, B.A., Grad.I.E.E. | 7/6 | 7/11 |

Obtainable from all leading booksellers or from

ILIFFE & SONS LTD., Dorset House, Stamford Street, London, S.E.1.

standardization does not end with the products of a single manufacturer. A given complete equipment may contain items made by several different manufacturers, and if they all have different ideas regarding the best method of interconnecting units, the proper external appearance of the gear, and the matching impedance of the input and output circuits, it will be impossible to make the complete assembly look efficient. It will be more likely to resemble one of the early experimental set-ups that are occasionally the object of derisive comparisons by the present-day engineers.

The only solution here lies in the adherence of the manufacturers to the more generally accepted standards. It may seem inconvenient to have to refer to standard specifications for every point of the design, but this at least ensures that the best method is used in the majority of cases. Young and over-enthusiastic engineers are often sure that they know a better way of doing a thing than that laid down by the standard specifications. They only succeed in causing considerable inconvenience to those who have to use the equipment they design. The flag of progress is a great inspiration, but it should only be followed when the existing method is unsatisfactory.

Standard Interconnections.

One of the most thorny standardization problems is that of interconnection methods. There are two general groups: terminals, which should be avoided wherever possible, and the plug-in connectors, which can be very good or equally bad, according to the type used. The general rule is that the leads should not be detachable by a simple pull, and the worst offenders in this respect are the terminals and open socket types. The best choice from this point of view is the type which has a screw-on cover which locks the cable termination firmly to the fixed part of the connector. This can also be used to ensure good earthing continuity if the cover is made of metal, which is desirable, in any case, as plastic materials cannot stand up to the rough treatment which is likely to be encountered. This type of connector also has the advantage of being waterproof.

Where connections have to be altered from time to time, the process of screwing the plugs in and out is liable to become tedious, and a quick-release type of connector is more appropriate. In any case, however, there is a considerable advantage in using multi-cored cable rather than single leads, though the improvement is greater where the leads have to be altered.

A final aspect of the interconnection problem is the cable itself. This is rarely suitable for standing up to the conditions which are likely to be encountered. In the laboratory, and even in the factory where the equipment is made, little trouble will be caused by the action of oil on the cable. In the place where the equipment is used, the situation may well be very different. Oil finds its way into all corners of workshops in which it is used, and in some places the cable may have to operate in a bath of oil: either a shower-bath from oily spindles, or a real soak in a pool on the floor. It is safe to say that ninety per cent of the cable used in industrial electronic devices is not fully suitable for the conditions under which it is required to work. This is often due to the fact that the right cable is not available. It should be made available, and the rules for ordinary wiring cable extended to cover the case. The result should be a better reputation for electronic equipment.

Conclusion.—These are just a few of the design points which must be considered when working on equipment for industrial use. There are many more; enough to fill a large textbook. Perhaps, however, this commentary on the more important items will encourage a little consideration of some of the finer points. If this consideration is not given to a greater degree than has been common in the past, the development of the use of electronic method in industry will proceed more slowly than it need.

The three main points which have been covered are: robust construction; ease of maintenance; adaptability. From these the characteristics of simplicity, efficiency, and neatness follow automatically. All the suggestions which have been made are prac-

ticable, yet many have been studiously ignored by some electronic manufacturers. Most of these are paying the penalty of their error to some extent. Others, protected by the present abnormal conditions, are surviving to make things difficult for the more careful manufacturer by spreading distrust of electronic methods.

It is too much to hope that the suggestions which have been made herein will pass unchallenged. Designers may agree, but will fall back on the defence line of "these difficult times" which has largely replaced the older expression "*C'est la guerre*" as an excuse for personal shortcomings. Theoreticians may argue, but the man who knows is the man who does the job. In the case of industrial electronic equipment the academic designer should realize that he has much to learn from the man who has to use the equipment. He had to learn such lessons from the reports of the services during the war, so that his equipment would be suitable for operation in the field. He can learn them again now, from the reports of the men in the workshops.



RADIO RE-HEATER.—Intended for re-heating pies, sausage rolls, muffins and other ready-cooked snacks (as opposed to cooking from the raw) this equipment, made by Radio Heaters, of Wokingham, works at R.F. on the dielectric heating principle. Power output, 0.5kW; frequency 75Mc/s.

Book Reviews

Ultra- and Extreme-Short Wave Reception. By M. J. O. Strutt, D.Tech.Sc. Pp. 387+xi, with 248 Figs. Published in U.S.A. by D. van Nostrand Co., Inc. Macmillan and Co., Ltd., St. Martin's Street, London, W.C.2. Price 37s 6d.

IF a striking example were needed to illustrate recent *Wireless World* Editorial criticisms of the nomenclature of frequencies and wavelengths, this book supplies it. The author does not define "extreme-short" (it may be noted, however, that "extremely-high frequency" has recently been proposed elsewhere for frequencies over 30,000 Mc/s), but he endorses the usually accepted limits of "ultra-high" frequencies (300-3,000 Mc/s). Yet the range covered by the book is given as 6 Mc/s-30,000 Mc/s. Still more curiously, "ultra- and extreme-high frequencies" are contrasted with "radio frequencies," which, apparently, are those lower than 6 Mc/s. Except where wavelength is appropriate, in connection with aerials, frequency is invariably used. Altogether, then, the title hardly seems to fit.

With this rather conspicuous exception the book is notable for its care and consistency in detail. To mention one small point, such expressions as "D.C. voltage" and "I.F. frequency" are scrupulously excluded.

There is no doubt that receiver developments in the next few years will fall largely within the range of frequencies covered by this book. Although, of course, mere increase in frequency does not alter basic principles, it does drastically shift the emphasis and the approach to practical problems. Much has been published piecemeal about all this lately, but what we have now is a consistent and balanced review of the whole applied to reception. Dr. Strutt has not wasted space on basic theory, nor even in expatiating on his own subject where it has already become fairly familiar, but briefly recapitulating such matters for continuity, and providing numerous references to specialized treatments, he has left himself space to deal with those aspects on which the reader is likely to be least well informed.

In the opening chapter, on Waves and Signals, data are supplied on propagation at the frequencies concerned; and the various types of modulation receive attention. Subsequent chapters are devoted to Fluctuation Noise, Antennas, Wave Conductors and Resonant Devices,

Measuring Instruments and Data, Entrance Stages of Receivers, and Further Stages and Over-All Design. Valves are not considered on their own, but as parts of receivers. Fluctuation noise receives such early attention because it is the factor to which most others have to be related; and this leads to a focusing of attention on the input stage of the receiver. The conceptions of "noise figure" and "available power" are expounded, and detailed procedure is given for measuring noise figure and power gain, though perhaps some of the possible sources of error are skated over rather lightly.

The treatment is practical. Mathematical formulæ are given where needed by the designer, generally without rigorous proof. Graphs are provided more for numerical data than to develop abstract theory. Advice is given on the mechanical as well as the electrical construction of instruments and receivers. One could wish that this information had been even more extensive.

Readers experienced in receiver techniques below 6 Mc/s will find in this book a well-balanced "conversion course" to the higher frequencies. M. G. S.

Micro-Waves and Wave Guides.

By H. M. Barlow, B.Sc., Ph.D. Pp. 122 and 70 Figs. Constable and Company, Ltd., 10, Orange St., London, W.C.2. Price 15/-.

THIS book has been written with a view to directing the attention of engineers to the possibilities in the applications of micro-waves. But the emphasis is on the latter half of the title; the two chapters dealing with micro-waves generally give only the briefest survey. The other six chapters of the book are devoted to wave guides. There is first an elementary treatment, deriving the general properties of guided waves from physical considerations. Its basis is a rather thin analogy with the parallel-wire transmission line, which in any intelligent reader will raise several unanswered queries.

There follows a derivation of Maxwell's equations, and then a mathematical treatment of the propagation of selected wave types in rectangular and circular wave guides and in coaxial lines.

The mathematics has been simplified as much as possible, but it seems pointless to introduce all the apparatus of the solution of the wave equation in two different co-ordinate systems with restrictions which produce as particular solu-

tions only the H_{0m} type for rectangular guides and the E_{01} type for circular guides. Admittedly these are the most used types, but so little more would have been involved in deriving more general solutions, with great advantage to the reader's appreciation of the subject.

The important question of attenuation in guides is also given a rather arbitrary treatment. If the proof of a formula is beyond the scope of a book it is of no help to state it first in a complex form and then reduce it to simple terms, as is done here. Although the possible importance of the low attenuation of the H_{01} mode in the circular guide is mentioned early on, no formula is given, and the graph showing this attenuation for one particular diameter of tube is not of much value.

Resonators, although they form an important part of micro-wave technique, receive only passing mention, and no formulæ are given.

The book appears to contain few errors or mis-statements, but the selection of its matter and its treatment are not such as would give the engineer the clear grasp of the subject suggested in the preface.

H. R. L. L.

Books Received

Electronic-Valve Bases, Caps and Holders. B.S. 448:1947.—This booklet contains detailed dimensional specifications for British valve bases and for base- and socket-testing gauges. It covers 4-, 5-, 7- and 9-pin bases, octal and Mazda octal bases, as well as the B3G, B7G and B9G valve bases and the 12-pin spigot and 12-contact key cathode-ray tube bases. It does not include valve-base connections. Pp. 68. British Standards Institution, 28, Victoria Street, London, S.W.1. Price 7s 6d (post free).

Principles of Electrical Engineering.—By T. F. Wall, D.Sc., D.Eng., M.I.E.E. The aim of this book is to present as comprehensively as possible, within the physical limitations of one volume, an account of the basic principles of electrical engineering. A set of questions on each of the 16 chapters is given at the end of the book. 563 + xi pages, with 532 diagrams. George Newnes, Ltd., Tower House, Southampton Street, London, W.C.2. Price 40s.

Test Papers and Solutions on Electrical Engineering.—By T. F. Wall, D.Sc., D.Eng., M.I.E.E. This companion volume to the author's "Principles of Electrical Engineering" includes the solutions to the 203 problems, chosen from examination papers for the B.Sc. (Eng.), Grad. I.E.E., etc., included at the end of the first volume. The material is arranged to emphasize the different aspects of the principles dealt with in the sixteen chapters. 312 + viii pages, with 371 diagrams. George Newnes, Ltd., Tower House, Southampton Street, London, W.C.2. Price 25s.

Multi-channel Communication System

Radio Network for a New Pipe Line

A CONTRACT for the supply of equipment for one of the most ambitious all-radio communication systems so far planned has been awarded to the General Electric Company of England. This installation is for a projected oil pipe line from the Persian Gulf to the Mediterranean, a distance of about 800 miles.

In its final form the backbone of the system will be a chain of V.H.F. radio stations comprising two terminal, five intermediate and a number of relay stations.

The choice of V.H.F. was governed by a number of factors. The nature of the terrain precluded the use of line circuits; fading and noise on M.F. and H.F. frequencies would be serious in that part of the world, while there was grave doubts of the likelihood of obtaining a sufficient number of exclusive radio frequencies for the nature of the services envisaged. These consist of several speech and teleprinter channels in either direction as well as a number for auxiliary purposes.

After full examination of all the

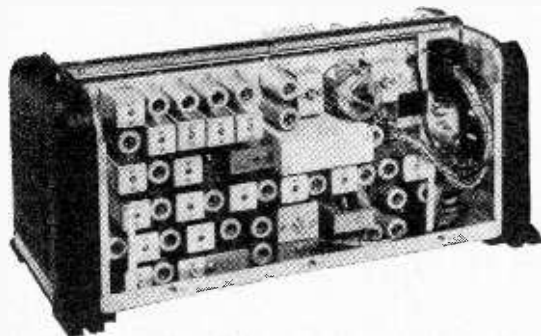

alternatives it was finally decided that a solution to the problem could be found by adopting multi-channel voice carrier technique, but in place of the customary physical conductor to use a wide-band frequency modulated V.H.F. radio link.

The very high frequencies are unlikely to cause, or to suffer from,

radio or other forms of interference and, moreover, the same radio frequencies could be used at several stations throughout the system. For it was realized at the outset that the adoption of this scheme necessitated a considerable number of repeater or relay stations to cover the 800 miles distance. An added advantage was that aerial gains of 12 to 15 db would be readily obtainable with reasonably sized arrays.

The scheme finally adopted aims at pro-

Model BRT400 wide-range communications receiver made by G.E.C. which will be used at terminal and intermediate stations along the pipe line.

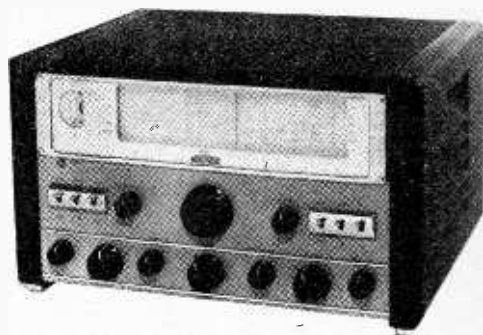

viding seven voice frequency channels in each direction, six being used for speech circuits and the seventh providing six teleprinter and six dialling circuits as well as a number for remote metering along the pipe line.

Integrated with the V.H.F. chain is an H.F. radio system based on

G.E.C. 20-watt mobile F.M. transmitter-receiver which will form part of the radio equipment in vehicles.

the terminal and intermediate stations and which will be employed primarily for communication with aircraft. At the two coastal terminals these sets will provide a radio link with oil tankers at sea. This service will operate in the 300 to 600kc/s band with provision for R.T., C.W. and M.C.W. operation, using a power of about 150 watts.

Each station will be equipped also with a wide-range communications receiver covering 150 kc/s to 33 Mc/s.

During the period of construction communication will be required between the base camps and field construction camps up to distances of about 150 miles and from the latter with the working parties over distances of a few miles. There is also the question of communication with servicing and transport aircraft and with vehicles travelling between the various camps.

For aircraft communication it is proposed to use H.F. links, but a further system of V.H.F. radio links is envisaged for the working parties and vehicles. Mobile sets operated from the vehicle's electrical system will be frequency modulated and give a transmitter output of 20 watts. The working parties will have pack sets of 0.25 watt output on fixed frequencies. Some of the vehicles will also carry H.F. equipment for working with aircraft.

In addition to the main multi-channel V.H.F. chain there is to be a direct radio link between the two terminal stations. This is mainly for administrative purposes. It will provide one speech and one teleprinter channel in each direction and for the service two 1-kW H.F. transmitters are to be employed at each end. Operation will be mainly on crystal-controlled spot frequencies.

Crystal control will also be employed in the receivers, which will be of the triple diversity type with highly directional high-gain aerial systems. Speech-scrambling equipment will ensure privacy.

TEST REPORT

Ekco Model A52

THE dimensions of this table model receiver (21in x 16in x 9in) are above the average, and advantage is taken not only of the increased baffle area of the front for good bass reproduction but of also of the length of the sloping front panel to provide a double tuning scale with a separate pointer for bandspread tuning indication on short waves.

A rotary programme selector switch gives five pre-tuned sta-

Bandspread Tuning on Short Waves

| FEATURES | |
|--------------|--|
| Circuit. | Superhet for A.C. supply. Four valves and rectifier. |
| Waveranges. | 11-14m, 16-20m, 24-50m, 200-550m, 1,000-2,000m. |
| Output. | 2½ watts. |
| Consumption. | 54 watts. |

Circuit.—The aerial coupling transformers are designed for constant gain, and an I.F. filter is connected across the primaries. The frequency changer is a triode-hexode and converts to an intermediate frequency of 460kc/s. Bandsread tuning is effected by small fixed capacitances in series with the main gang condenser, and the five pre-tuned circuits are trimmed by capacitance in the oscil-

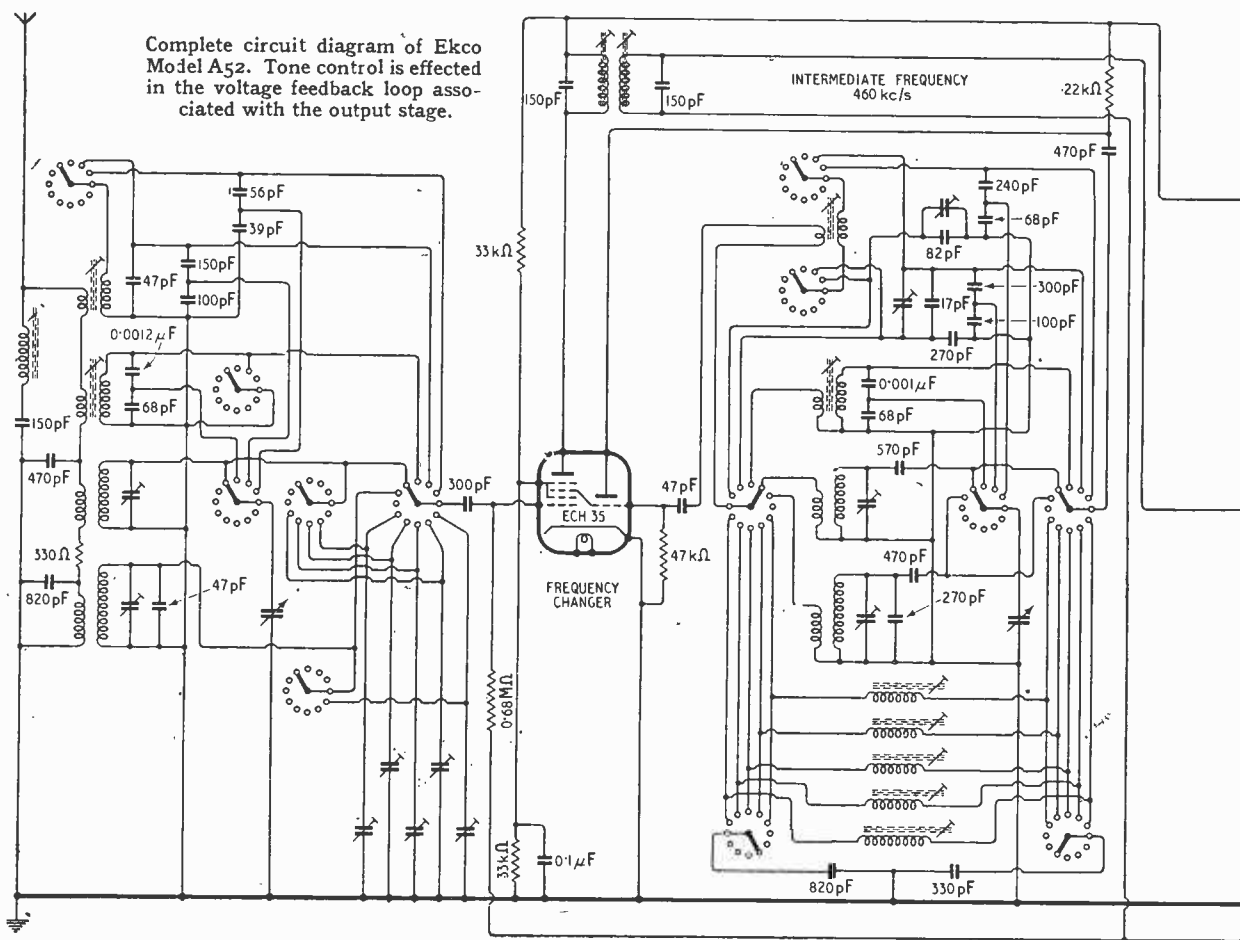

tions and a choice of five wavebands as well as a position for record reproduction from a pick-up. The three short-wave ranges

do not give continuous coverage but are arranged to expand the principal broadcast bands between 11 and 49 metres.

lator circuits. The I.F. circuits are adjusted by movable iron cores and the feed for the A.V.C. diode is taken from the anode of

the I.F. valve. The I.F. stage is muted by the application of excessive negative bias when the circuit is switched for gramophone reproduction.

Tone control in the output stage is effected partly by resistance-capacitance shunts and partly by a frequency discriminating feedback circuit between anode and grid circuits. The anode stopper resistance in the first stage is fairly high and has probably been introduced on account of the low input impedance of the power valve with voltage feedback.

Performance.—Quality of reproduction is much above the average for a table model. Not only is the tone round and full, but there is a good effect of "presence" in all types of transmission. Transient response is good and pianoforte playing sounds like the real thing.

The three-position tone control does not give wildly contrasting responses, but just the gradation

and this gives adequate high-frequency response without any suggestion of harshness.

The selectivity on medium and long waves is good and there are no traces of self-generated whistles. Tuning on the short-wave ranges is easy and the set is exceptionally sensitive, even on the shortest wavelengths. It is unusual to find broadcast sets with special provision for the 11- and 13-metre bands and the makers are to be commended on this extension of the usual short-wave range.

Constructional Details.—The cabinet work is of a high stan-

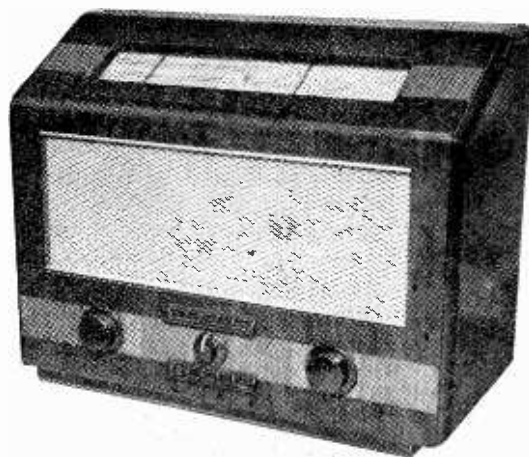

general illumination of the interior of the cabinet. A third pilot light carried on an arm on the main switch spindle illuminates the appropriate station and wave-range panels in detachable escutcheon plates on the front panel.

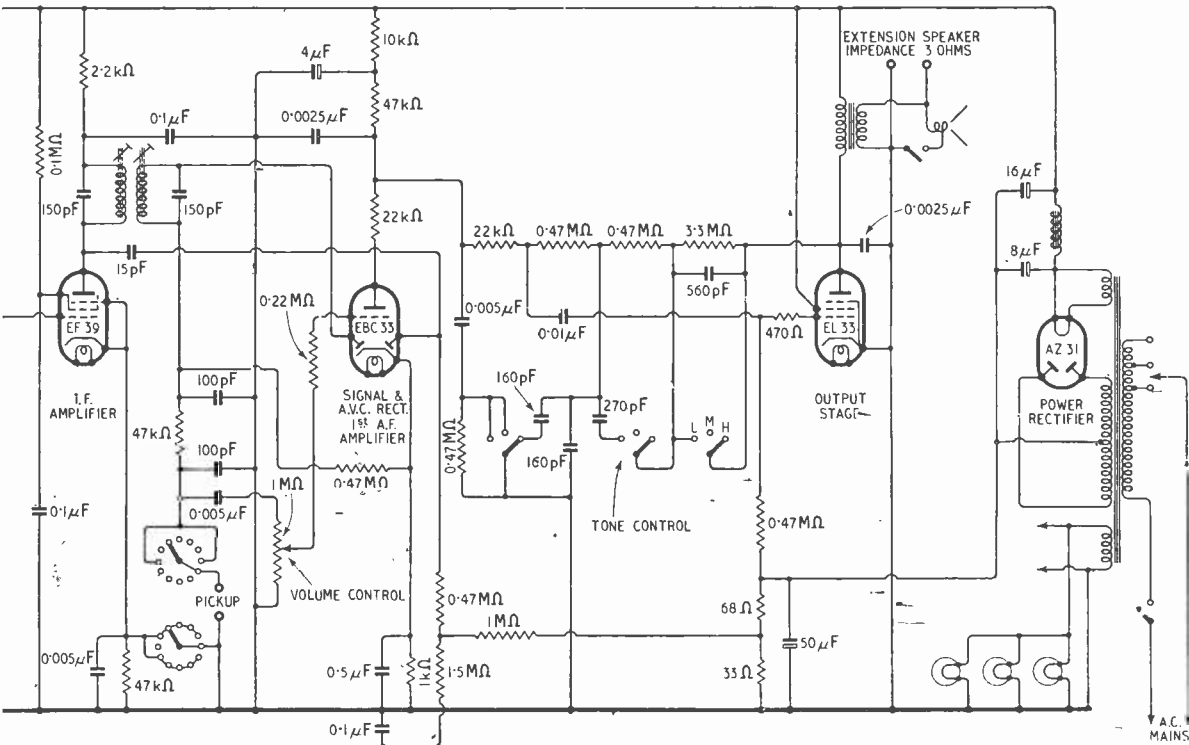

necessary to cope with background noise or sideband interference. Normally, one can make full use of the "High" position,

dard, with a satin veneer finish. Illumination of the tuning scale is by two lamps which are mounted accessibly on the chassis and give

The single chassis unit runs the full width of the cabinet and all components are well spaced and accessible. Trimmers for the pre-

Ekco Model A52—tuned stations are arranged in adjacent rows at the back of the

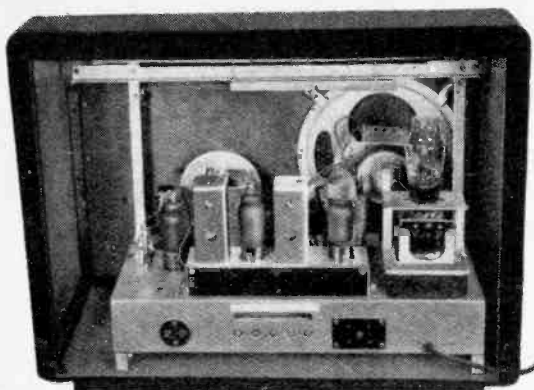

chassis and can be adjusted by screwdriver.

A knurled screw switch in the

centre of the pickup and extension loudspeaker terminal panel disconnects the main loudspeaker if this is not required when the

Interior of Ekco Model A52. The scale lamps also give general illumination of the interior of the cabinet.

external unit is working.

The makers of the A52 are E. K. Cole, Southend-on-Sea, and the price is £28 7s plus £9 4s 4d purchase tax.

Single-valve FM Converter

A GOOD deal of interest, as well as some criticism, seems to have been aroused in America by a circuit recently introduced by the Hazeltine Electronics Corporation. With the help of one double-triode valve the Fremodyne, as it is called, converts an incoming F.M. signal into a form suitable for feeding the A.F. amplifier of a conventional A.M. receiver.

One section of the valve works as the local oscillator necessary for superheterodyne conversion, while the other section functions as (1) a superheterodyne converter to an I.F. of about 22 Mc/s; (2) a super-regenerative I.F. amplifier of high gain; (3) an F.M.-to-A.M. converter, and (4) a detector giving an A.F. output. The need for manual reaction control of the super-regenerative circuit is avoided by using an automatic stabilizer.

The F.M. signal developed across the input circuit is applied to the grid of the super-regenerator section and mixed with the local oscillations; the resulting 22-Mc/s I.F. is amplified by the super-regenerative detector, which feeds into the audio amplifier of a normal receiver.

The circuit has been criticized in the American journal *Electronics* on the grounds of radiation and poor audio-frequency response characteristics, though the

sponsors claim that signal-frequency radiation is some 30-40db less than that of an ordinary super-regenerator. Another disadvantage is that, as side-tuning is used, there are two positions on the tuning dial for each station; both positions represent correct tuning.

Reprints of Articles

THE following is a list of reprints of articles which have appeared in recent issues of *Wireless World*.

The price of each of the reprints, with the exception of "Television Receiver Construction" which costs 2s 6d (by post 2s 9d), is 6d or, by post, 7½d. They are obtainable from our Publisher, Dorset House, Stamford Street, London, S.E.1.

Ex-Government Valves and C.R. Tubes. List giving valve type designations and their commercial equivalents (August, 1945), together with the characteristics of some ex-Service C.R. tubes (December, 1947).

"Wireless World" Quality Amplifier. Circuit details for 4-, 8- and 12-watt designs. January, 1946.

Ex-R.A.F. Communication Receiver. Modifications to the R1155 for civilian use. July, 1946.

Push-pull Phase Splitter. New high-gain amplifier circuit. By E. Jeffery. August, 1947.

Quality Superheterodyne. Design for a nine-valve receiver. By S. A. Knight. December, 1947.

High-Quality Amplifier Design. Circuit details for an amplifier with tetrodes in push-pull in the output stage. By P. J. Baxendall. January, 1948.

Television Receiver Construction. Details for building a straight vision receiver and a sound channel (up to the detector) sync separator, line and frame time-bases and power supply unit. January-December, 1947.

Marconi Aircraft Radio

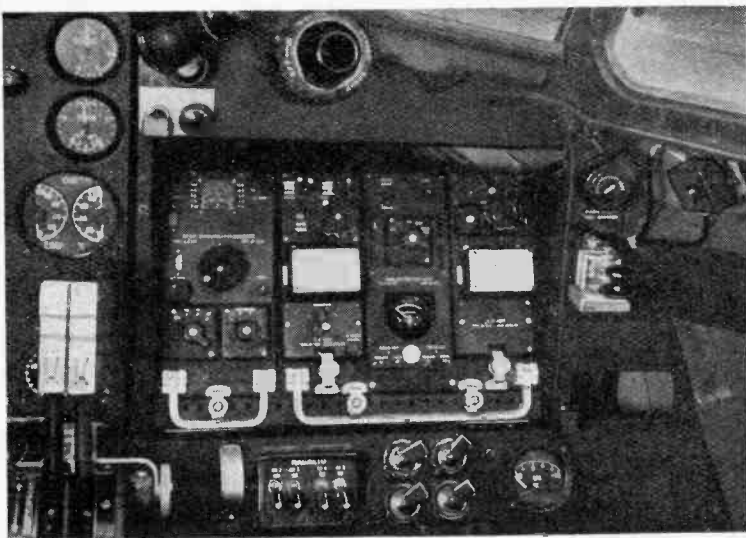

MARCONI LIGHTWEIGHT RADIO INSTALLATION, AD97/108, fitted in standard-type racking in an 8-11 seater de Havilland Dove passenger air transport

Does Distortion Matter?

A LIVELY and interesting discussion on the subject "To What Extent Does Distortion Matter in the Transmission of Speech and Music" was recently opened before the Radio Section of the I.E.E. by P. P. Eckersley, former Chief Engineer of the B.B.C. He stressed that his remarks were intended to indicate the heads of a fact-finding agenda rather than to be dogmatic.

On the general issue, he pointed out that the conditions must be defined before raising the question whether this or that form of distortion "matters." The absence of a few octaves did not matter to the telephone user, nor was the broadcast listener much worried by distortions if the programme were vitally interesting. On the other hand, the sensitive ear of a musician resented the combination tones and the missing frequencies which were too often the characteristics of the reproduction of orchestral performances.

There were technicians who argued that all types of distortion mattered and that, until the sound field to which the ear of the listener was subject was an exact replica of that in which the microphone was situated, their task would not be complete.

There were others who believed that the inevitable artificialities of practice denied the possibility of really faithful reproduction. But just as a two-dimensional picture of a three-dimensional subject could be harmonious and beautiful, so an artificial reproduction of sound could give pleasure and evoke emotion. Assuming that argument to be true, then some forms of distortion did not matter.

So long as we could not have binaural reproduction and had to contend with the superimposition of the acoustics of the place in which we listened on those of the place where the sounds were received by the microphone, the result must lack absolute fidelity. As fidelity was finally judged by the ear of a human being with an emotional capacity, the technician would have to learn to what extent he might synthesize the original sound in order to evoke emotion and give pleasure to the human being.

Generally speaking, the public that listened to broadcasts, record-

ings and public address systems was satisfied; it tolerated distortion for the sake of an ultimate pleasure or convenience. This toleration of the public, however, did not justify the technician's neglect of the outstanding problems of reproduction—far from it—for a better synthesis mean-

Extent of Its Effect on Reproduced Speech and Music

ing more pleasure and convenience for everyone.

Turning now from generalities to a more technical examination of the problem, Mr. Eckersley said the most obvious deficiency was the failure to reproduce the full audio spectrum—the upper frequency region was subject to serious attenuation.

Efforts had been made during recent years to increase the frequency response by one or two octaves but the result, at least to some ears, had been singularly disappointing—the "glitter" of the modern "top" was more offensive than the previous mellow boom—so that one was often thankful for a tone control which eliminated the unpleasant harshness. A recent consensus of American opinion had shown that the average person did not like high-fidelity reproduction. If high-fidelity reproduction meant the mere inclusion of a greater proportion of high-frequency waves and the disregard of any other factors, then American opinion was acceptable. One must ask why should a loudspeaker, which gave a reasonably constant output power over a wide frequency band, under steady-state conditions of measurement, nevertheless gave a reproduction of speech and music which, by aural judgment, was unsatisfactory.

An uninformed opinion might have suggested that the wider the

window was open the more dust was blown in, or, to put this analogy in technical phraseology, harmonics and combination tones might dominate the feeble components of the upper spectrum, and therefore it was better to remove everything than to be left with a host of spurious tones which masked the subtleties of the upper register.

If the difficulties encountered in reproducing a clean "top response" consistent with low production costs were too formidable, then the question arose: "What shape would the attenuation/frequency-characteristic curve have to take in order to give the most pleasing synthesis?" Some while ago opinions were expressed that a loudspeaker giving a maximum response in the middle register; i.e., 800-1,200 c/s, and an attenuation curve rising symmetrically on either side of this peak, produced a result more acceptable than that obtained with a curve which was asymmetrical about a middle frequency band. The opener asked whether that proposition had been examined and, if so, was it valid when tested scientifically?

In that connection it had been stated that better results could be obtained when using a characteristic that showed falling attenuation for rising frequency; this artificiality was said to balance that arising from the superimposition of the acoustics of the room in which the listener was situated on those of the studio or auditorium whence the sound waves emanated.

Reports on the progress of the research on the vibration of loudspeaker diaphragms and armatures would be interesting. A theory existed that a distortion in reproduction was caused when any moving mass in a transducer continued to vibrate after the stimulus causing it was cut off abruptly. Perhaps that had some bearing on the difficulty in obtaining satisfactory wide-band response.

Many modern amplifiers produced combination tones and harmonics. Even harmonics were said to produce less offensive distortion than odd harmonics, owing to their octaval relationship. Combination tones were probably more offensive than harmonics. Therefore, assuming a distortionless amplifier, it seemed

Does Distortion Matter?—

probable that many loudspeakers themselves produced combination tones owing to their non-linear response curve with changing amplitude.

If this discussion were to be comprehensive, it should not be confined wholly to considerations of broadcast and gramophone reproduction. An increased intelligibility of the public telephone service would be of real value. It appeared that a great deal of work was centred upon the receiver, whereas the carbon transmitter remained the weak link in the chain. Mr. Eckersley asked what were the plans to improve matters on both a long and short-term basis?

Another difficult problem was measurement. How, for instance, was it proposed to extend the frequency range at which accurate measurement of sound power could be made; was the probe microphone to remain limited in use to frequencies up to 3-4 kc/s, a gamut in which it had proved so valuable?

Slow Progress in Broadcasting

Returning to broadcasting, it was disappointing to note how relatively little improvement had been made over a long period of years. This was not to say, for instance, that when a modern expensive receiver was situated close to a powerful broadcasting station, it could not take advantage of the many valuable improvements that had been made in studio, microphone and recording techniques (and which were sometimes available to the public). The point it was desired to make was that the average middle-priced domestic radio receiver used in a normal manner gave only an average result because usually the available frequency spectrum was limited by sideband interference. So long as radio programmes were distributed by the obsolescent system of radiating modulated low- and medium-frequency carrier waves, so long would the incentive to make available to the public better reproducing instruments be lacking. The public had grown accustomed to accept a mediocre standard of clarity from their radio receivers; that tolerance of the public ear encouraged laziness.

Thus, while it would be of no value to set up high-fidelity transmitting systems if the average receiver could only handle it by

reproducing additional harsh upper octaves, yet it would at least provide the basis to obtain that better synthesis which, while not necessarily reality, would be a greater source of pleasure — what else mattered?

The discussion which followed showed that, while there was reluctance to abandon the thesis that perfect reproduction could be achieved ultimately, most speakers thought that there were limits of technical elaboration and cost which at the present time prevented practical realization of perfection by known methods. In any system of distribution—broadcasting, wire relay or gramophone records—the originators of the programme had no control over the reproducing equipment, which included the listening room. One speaker contended that perfect reproduction was impossible in the average living room, not only because there were characteristic vibration modes (eigentones) which might increase the sound level by as much as 25 db at some frequencies, but also because the repetition frequency of reverberation of sound pulses (e.g., single staccato notes) was much higher than in a large concert hall and had an irritating effect. The contrary view was expressed by another speaker who contended that the ear was conditioned to accustomed surroundings and became alert only to unaccustomed conditions; e.g., a bathroom or the Albert Hall. Under steady-state conditions the room acoustics were relatively unimportant and subjective curves of the loudness/frequency response of the same loudspeaker taken in "live" and "dead" rooms showed only minor differences. The rate of decay of vibration in a loudspeaker after the input had ceased might pass unnoticed if it were similar to the reverberation characteristics of the listening room.

The loudspeaker was notoriously the weakest link in the chain and could be a prolific source of harmonics and combination tones. A three-dimensional model was shown of the amplitudes of harmonics developed by a loudspeaker for various fundamental input frequencies throughout its range. This indicated wide variations of amplitude characteristic with frequency. There was also much to be learned about the relationship of the electrical and mechanical impedances of a loudspeaker.

The difficulties of extending the high-frequency range were discussed at some length. It was thought that the experiments of Chinn and Eisenberg in America did not prove that listeners preferred a restricted frequency range, but that they objected to subtle distortions introduced by the equipment. The quality of the high-frequency response could be judged by listeners' reactions to a top cut; in a bad reproduction the result would be described as "mellow," in good reproduction, "muffled." The experiments of Olsen with direct listening through acoustic filter screens confirmed this opinion.

One speaker thought that too much attention had been given of late to high-frequency response and that it was of even greater importance to make sure of a clean bass response, since harmonics of low frequencies could cause trouble over a wider frequency range.

The presence of combination tones was not always a sign of distortion in the equipment. The orchestra itself was a prolific source, particularly when there was faulty intonation in the playing. It was necessary for engineers to learn to distinguish the origin of combination tones, and to this end direct comparison between the original and the reproduced sound should be made on every possible occasion. It would be found that the tolerance of the ear for distortion depended to a marked degree on the nature of the programme material.

Do Musicians Know?

Controversy developed over the value of the trained musician as a judge of quality of reproduction. Some speakers held that executant musicians such as organists, who were skilled in selecting and combining tone-colours, could give valuable advice; others that musicianship was a disadvantage, since it was an intellectual rather than a sensory talent. The form of the composition and the technique of performance took precedence in the mind of the musician listener over the quality of individual instruments. Perfect reproduction was not essential, and a synthesis giving a satisfactory resolution of the various instruments of the orchestra would carry all the "information" necessary to the enjoyment of the composer's ideas.

THE "BELLING-LEE PAGE"

Providing technical information, service and advice in relation to our products and the suppression of electrical interference

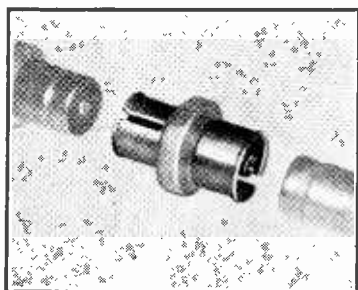

The new coaxial line connector L616 is shown here. It is interchangeable with the range and sells at 3/-

We are asked for a satisfactory method of joining lengths of co-axial cable, at best a tricky operation.

Our own installation department frequently require the same facilities, and we benefited by our war-time experience of supplying airborne dipoles and feeders which were installed in component parts of aircraft—fuselage, wing sections, etc., and at the point of assembly the co-axial feeders were plugged together. For our present-day requirements, when wiring a building, or for example an exhibition, we use two plugs L.604 at 1/6 each and one line connector L.616 at 3/-. If considering the matter of saving odd lengths of feeder at say 1/3 per yard, the cost is about equal for joining five yards, and anything over five yards shows a very considerable saving.

The Post Office Engineering Department responsible for investigating reported cases of interference are reluctant to take action unless the listener making the complaint has a reasonable aerial. A large number of complaints are ascribed to indifferent aerial arrangements, and in view of this known fact we are surprised that sets should be widely advertised as "requiring no aerial." The difference in quality of reception between a receiver using no aerial and one using just a "Winrod" window mounting aerial has to be experienced to be appreciated, and surely 19/6 is not too much to ask even for an aerial intended for use with a "second" receiver in the home. This price would be less than the cost of an alternative method of wiring for multi-point reception. It would, of course, not be an anti-interference aerial such as the "Skyrod"*1 and "Eliminoise"*2, but where interference is not too severe one can use a short length of screened feeder.

From Blackpool and Leigh we hear of dealers using with considerable satisfaction "Winrod" aerials with screened feeder to combat such interference. This is quite a logical development. Without doubt a "Winrod" window mounting aerial is more efficient than any indoor aerial. It is outdoors and it does stick out away from the building. Such an aerial is bound to give an improved signal to noise ratio, unless interference swamps the programme. There might still be interference picked up by the lead-in from the aerial to the set or picked up from the mains wiring in the house or building. By screening the lead-in with a few yards of low capacitance screened cable, this pick up of "not too severe" interference will be prevented. As a word of warning we would not recommend the use of a screened lead unless the "Winrod" was mounted not nearer the ground than a first-floor window sill. We cannot overstress the point that the length of this screened lead should not exceed five or six yards, and that a good quality co-axial be used such as L.600, or the losses will be greater than the gain. In a truly anti-interference aerial of good quality such as the "Eliminoise," transformers are introduced at the collector end of the cable, and again at the receiver, for the express purpose of matching the impedance of the aerial to the screened cable, and back to the input impedance of the receiver.

The "Eliminoise" can, of course, be used with a "Skyrod" erected well out of range of severe interference, and a long screened lead may be taken to the receiver without appreciable loss of signal.

So far as "Belling-Lee" is concerned we do not really mind whether we sell aerials or interference suppressors. But we would remind readers that a set lead suppressor L.300 sells at 59/6, whereas a "Winrod" aerial L.581 sells at 19/6. In many cases where a receiver is picking up a lot of interference, a "Winrod" is the most reasonable proposition for the listener.

R.C.M.F. EXHIBITION

We hope you will come and visit us at the above Exhibition to be held at the Grosvenor House Hotel, Park Lane, London, W.1, on March 2nd to 4th inclusive. Our Stand is No. 34. We shall be showing a comprehensive range of components and aerials, many of them available for the first time. These include

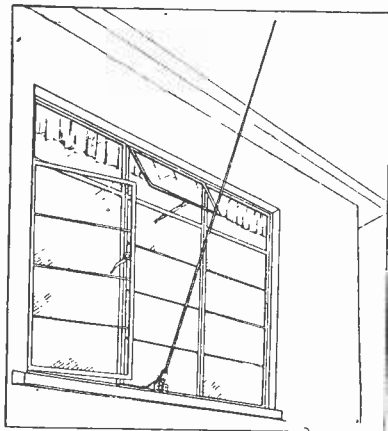

The illustration shows the "WINROD" window aerial L581. Price 19/6. (Note to dealers at foot of page)

the new B8A valveholder, our range of Television and car radio co-axial plugs and sockets with an outlet box for skirting board termination. A new two-pin reversible or non-reversible plug for use with our balanced twin feeder L.336. Our range of suppressors include a new design in car suppressors, which screw into the H.T. lead socket on the distributor, while the terminal carrying the lead from the coil screw into the head of the suppressor. An essential item for the prevention of interference with the Television and Electronic industry.

*1. "SKYROD" (regd. trade name) 18ft. collector in 3 sections with chimney lashings.

L.518 Collector only £4 4s.

L.618 Complete with "Eliminoise" equipment and screened feeder, £10.

*2. "ELIMINOISE" (regd. trade name) L.308k aerial and receiver transformers, 50ft. screened feeder, aerial and earth wire and insulators complete, £6 6s.

*3. Set lead suppressor, L.300/3. £2 19s. 6d.

Note to dealers :

"WINROD" AERIALS, ex-stock, from your wholesaler (supplied in cartons containing 6).

BELLING & LEE LTD
CAMBRIDGE ARTERIAL ROAD, ENFIELD, MIDD.



**CONSOLE
REPRODUCER MODEL KC10**

Designed for better listening in the home, the KC10 Console Reproducer incorporates the K12/10 12 in. moving coil loudspeaker in an acoustically damped, totally enclosed, cabinet of optimum dimensions. The walnut veneered cabinet is hand polished and fitted with an anodised aluminium grille. PRICE 20 Gns.

**ELIMINATE
SOUND
DISTORTION**

Can distortion be eliminated? Not quite, of course, but it can be reduced to a minimum by the use of loudspeakers which will introduce as little discoloration as possible—well designed loudspeakers—Vitavox loudspeakers in fact.



MANUFACTURERS OF SOUND EQUIPMENT

VITAVOX LIMITED
Westmorland Road, London, N.W.9, England
Grams : Vitavox, London, England

**E.M.I. TRAINING
FOR CAREERS IN ELECTRONICS**

E.M.I. basic training fits you for entry to Careers in such fields as :—

- SERVICE ENGINEERING
- OPERATING
- DESIGN AND DEVELOPMENT
- TECHNICAL SALESMANSHIP
- TEACHING



The Correspondence and College Courses provided by E.M.I. Institutes which cover recognised diplomas such as the City and Guilds, etc. are written and supervised by E.M.I.★ scientists who are specialists in Electronic Science.

Courses are already available in such subjects as Basic Radio, Basic Television, etc., and the prospectus is being constantly extended.

With this basic training you can eventually become a specialist in Television Radio Communications, Radar, Navigational Aids, Audio Frequency, Medical and various Electronic applications. There are also short courses for Executives, Amateurs, Students, etc.

For full details apply to your local "H.M.V." Radio dealer or direct to :—

The Principal : PROFESSOR H. F. TREWMAN, M.A. (Cantab), M.I.E.E., M.I.Mech.E., M.Brit.I.R.E.

E.M.I. INSTITUTES LTD
Dept. 16, 43, Grove Park Road, Chiswick, London, W.4

★ The E.M.I. Group includes "H.M.V.", Marconiophone and other important electronic interests

Manufacturers' Products

Universal Oscilloscope

AN interesting oscilloscope has been developed by Cinema-Television, Ltd., of Worsley Bridge Road, Lower Sydenham, London, S.E.26, and was shown recently at the firm's private exhibition. Known as the Universal Oscilloscope, it incorporates a 6-in tube and is built as a desk-type instrument with a sloping front. It measures 3ft 6in high by 2ft square.

It is unit built and each unit has its own power supply to avoid interaction. The units can be varied to suit individual requirements. They include a simple time base covering 5c/s to 150kc/s and an amplitude-stabilized time base with an upper limit of 250kc/s. This gives a constant-amplitude trace and is calibrated in frequency with an accuracy of ± 4 per cent.

There is a signal amplifier covering 5c/s to 1.5Mc/s, which provides an output sufficient to fill the screen with an input of 1VR.M.S. and the gain control has sufficient range to permit it to accept an input of 25V. The alternative amplifier is direct coupled and covers 0-5Mc/s; again, the input is 1V for full deflection.

Both double- and five-beam switch units are available. The latter permits five traces to be displayed together. There are five amplifier

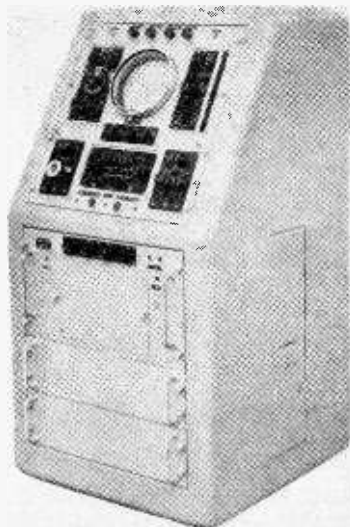

Cintel Universal Oscilloscope

channels, each covering 0-5 Mc/s, switched by a ring-of-five counting circuit. Internal switching frequen-

cies of 90c/s, 750c/s, and 8kc/s are provided and by external control frequencies of 50c/s to 30kc/s can be used.

Midget Coils

THE present-day trend to reduce the size of all components where possible is well exemplified by the new range of miniature coils wound on Polystyrene formers obtainable from Meteor Electronics, 1, Gloucester Row, Esplanade, Weymouth, Dorset.

The moulded formers measure only $\frac{1}{2}$ in dia. and they have adjustable dust-iron cores. Medium and long waveband coils, aerial, R.F. transformers and oscillator types are wound with Litz stranded wire, while an appropriate gauge of

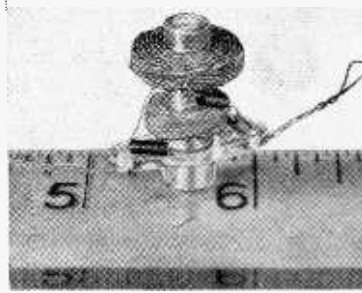

Meteor type M.D. midget coil on Polystyrene former with adjustable dust-iron core. Its size can be judged by comparison with inch markings on the ruler.

enamelled conductor is used for the short-wave units. Coloured sleeves are threaded over the loose ends of the coils for identification purposes.

These midget coils are known as M.D. type. As examples of price, medium- and long-wave aerial coils cost 3s 3d, R.F. transformers 3s, and oscillator coils for a 465-Kc/s I.F., 2s 9d each. Short-wave coils of all types cost 2s 6d each.

Albion Coil Packs

A RANGE of coil packs for use in superheterodyne receivers, embodying small but efficient dust-iron cored coils, has been introduced by the Albion Radio Manufacturing Co., Mill Lane, Margate, Kent. They are made in three- and four-band types and several models are available in each style.

The three-range models, for example, give the choice of an alternative short-wave band which can

be either 19 to 50 metres or 13 to 35 metres. Likewise the four-range packs are available with short-wave bands of 19 to 50 and 90 to 250 metres, or 13 to 35 and 34 to 100 metres. The medium and long-wave

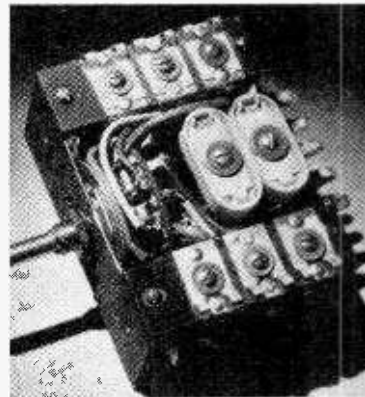

Albion three-range coil pack without screening cover. It will be seen that all trimmers and padders are very accessible.

coverages are 200 to 550 and 800 to 2,000 metres respectively.

Either style is available completely or partially screened and with or without an I.F. filter for 465 kc/s. Wave-change switching with a gramophone pickup position is included, together with all trimming and oscillator padding capacitors. Complete circuit details of typical all-wave superhets embodying these coils are included with each unit.

Prices range from 36s 6d for a partially screened three-range model to 48s 6d for a four-range fully screened pack fitted with an I.F. filter.

A.C./D.C. Receiver

A UNIVERSAL mains equivalent of the Model 371A has been produced by Philips Electrical, Century House, Shaftesbury Avenue, London, W.C.2. To be known as the Model 371U, the new receiver employs a CCH35 frequency changer, EF39 I.F. amplifier, EBC33 detector, CL33 output, and CY31 rectifier, with a consumption of 66 watts at 220 volts. The price will be £16 16s, plus £5 7s 10d purchase tax.

Hermes "Radio Tourist" Portable

The description of this receiver on p. 47 of the February issue referred to the sliding aerial as a metal panel. In fact the aerial is a small frame winding enclosed in a moulded plastic panel. Incidentally, the price of this set, including waterproof carrying case, is now £14 14s, plus £4 14s 9d purchase tax.

WORLD OF WIRELESS

Licence Record ♦ Radio Exhibitions ♦ Interference Suppression ♦ Salaries and Status

OVER 11,000,000

AN increase of over a quarter of a million broadcast receiving licences during 1947 brought the total for Great Britain and Northern Ireland to approximately 11,057,000 at the end of the year. The December figure included 32,700 television licences.

Holders of "sound" licences (£1) are reminded by the P.M.G. that it is now necessary to take out a £2 television and sound licence immediately a television set is installed. A rebate on the unexpired portion of the surrendered £1 licence will be made at the rate of 1s 8d per month.

RADIOLYMPIA

IT has now been decided by the R.I.C. that there will not be a national radio exhibition this year. Plans are, however, being made to hold the next exhibition at Olympia in the autumn of 1949.

The decision not to have a show this year has been made in order to enable manufacturers to concentrate on production for the industry's £12,000,000 export target set by the Government.

COMPONENTS EXHIBITION

THE fifth annual exhibition of radio, television and electronic components and test gear, organized by the Radio Component Manufacturers' Federation, will be held in the Great Room, Grosvenor House, Park Lane, London, W.1, from March 2nd to 4th. Admission to the exhibition is by invitation of the Federation and accredited radio engineers and manufacturers are cordially invited. It is hoped to include a report in our next issue.

"SCIENTIFIC RADIO" CONVENTION

THE I.E.E. is planning to hold a convention on "Scientific Radio" on April 7th and 8th. This is in some respects a preliminary to the meeting of the Union Radio Scientifique Internationale, to be held in Stockholm later this year, as from it will be correlated the British contribution to that meeting. The convention is being organized in collaboration with the British National Committee for Scientific Radio set up by the Royal Society.

Sessions will be held during the afternoon and evening of each day

from 2-4.45 and 6-8.45. The subjects to be covered by the four sessions are: standards and measurements, propagation, radio noise and radio physics.

Invitations to the convention, which will be held at the I.E.E. headquarters, Savoy Place, London, W.C.2, are being sent to kindred learned societies.

TELEVISION INTERFERENCE

ACTIVE measures are being taken by the Radio Industry Council to eliminate electrical interference with television reception. Since the worst source appears to be motor car ignition systems this is being tackled first. Moreover, from 85 to 95 per cent of this interference can be eliminated by fitting a resistor of from 5kΩ to 10kΩ in the H.T. lead from the ignition coil to the distributor.

Two types of suppressor are now available; one is a screw-in fitting for the centre of the distributor and into which the lead from the coil is fitted as usual, while the other is a bakelite tube 2in long and ½in in diameter which is inserted in the lead between the coil and the distributor. The cost is 1s 6d. Investigations have proved that the one resistor needed has no harmful effect of any kind on the performance of the average car engine.



Ignition interference suppressors recommended by the R.I.C. On the left is a screw-in type for the distributor and on the right a resistor for inserting in the H.T. lead from coil to distributor.

Many large-scale users of motor vehicles have already suppressed their cars or are about to do so; these include the G.P.O., B.B.C., all police authorities throughout the country, London Transport, and the National Road Transport Federation. Incidentally, all staff cars operated by our Publishers are suppressed.

The R.I.C. campaign has already resulted in traders and dealers throughout the radio industry giving a lead by suppressing their motor vehicles.

TECHNICIANS' SALARIES

A CHARTER for technical staff in the engineering and metallurgical industries has been produced by the Association of Scientific Workers.

The grading and minimum salary scales set out in the charter are intended to apply to engineers, metallurgists, chemists and other scientific and technical workers employed in laboratories, etc.

The salaries, which include the 1947 cost-of-living bonus paid in the engineering industry, vary from £5 10s a week for a 21-year-old assistant without academic qualifications to £1,250 a year for a senior engineer in a supervisory capacity. An engineer with the experience and/or qualifications making him eligible for corporate membership of the appropriate professional institution, who is not younger than 21 years of age, will receive £440 p.a. rising by ten yearly increments of £26 to £700.

SERVICE TECHNICIANS' STATUS

RATES of pay have also been agreed between the Radio and Television Retailers' Association and the Guild of Radio Service Engineers for service technicians. These will apply to men on the Radio Service Trade Register and are based on the certificated qualifications as set out below. Men over 21 years of age who are not on the register are covered by an earlier agreement and will be paid not less than £5 5s per week.

The three classes of certificate and the rates of remuneration are:—

Certificate "A", issued to persons admitted to the Register by virtue of their having passed the R.T.E.B. examination, £6 5s. per week.

Certificate "B", issued to radio service technicians admitted to the Register on the basis of having served an approved apprenticeship or having had five years' experience in approved employment, £6 per week.

Television Certificate, issued to holders of "A" or "B" who have also satisfactorily passed the television course of a manufacturer, £6 10s per week.

AMATEURS' EXAMINATION

THIS year's City and Guilds of London Institute examination for prospective amateur transmitters will be held on May 5th from 7 to 10 p.m. Candidates should apply to their local technical colleges for particulars and entry forms which must

be completed by March 1st. As previously stated there will be only one examination this year.

PERSONALITIES

F. J. Addington Hall has taken charge of the radio accessory and domestic appliance marketing division of Truvox Engineering Co., and T. W. Spurr the contracts division.



J. W. RIDGEWAY—new Radio Industry Council chairman.



R. J. KEMP, Marconi's new chief of research.



J. A. SMALE—now engineer-in-chief, Cable and Wireless.



F. NEIL SUTHERLAND—Marconi's new general manager.

J. R. Hughes, A.M.I.E.E., M.Brit.I.R.E., who was technical secretary of the British Radio Valve Manufacturers' Association from 1942 until the end of last year, has now joined Ilivac, Ltd., and will be responsible for all technical liaison both with customers and with associated companies. Prior to joining B.V.A. he was engaged in telephone engineering with Siemens Bros., Woolwich.

J. W. Ridgeway, O.B.E., a director and radio division manager of the Edison Swan Electric Co., has been elected chairman of the Radio Industry Council for the current year in succession to G. Darnley Smith, of Bush Radio. C. O. Stanley, C.B.E., chairman of the board of Pye, Ltd., has been elected vice-chairman.

J. G. Robb, Marconi's deputy chief engineer and chief of the company's research laboratories, has been appointed chief of a new engineering division established by Marconi's and its associated companies. He is succeeded chief of the research laboratories by his assistant, R. J. Kemp.

J. A. Smale, A.F.C., B.Sc., M.I.E.E., who has been appointed Engineer-in-Chief, Cable and Wireless, succeeds G. H. Entwisle, who retired in January. Mr. Smale has been concerned with developing long-distance short-wave relays as a means of overcoming unfavourable propagation conditions, and wrote on this subject in *Wireless World*, August, 1944. He also originated important development work on frequency-shift keying and organized wartime emergency wireless circuits. He attended all the more recent international conferences.

F. Neil Sutherland, M.A., M.I.E.E., has been appointed general manager of Marconi's Wireless Telegraph Com-

pany. He joined the English Electric Company, the parent company, in 1922 and in 1925 became its chief engineer in South America. In 1936 he was appointed managing director of English Electric in South Africa.

Capt. B. R. Willett, C.B.E., D.S.C., has relinquished his post as general manager of Marconi's on being appointed to undertake a mission to overseas countries to intensify the company's export trade.

Dr. R. C. G. Williams, Ph.D., B.Sc.(Eng.), M.I.E.E., who, after a few months in the U.S.A., was appointed an executive engineer of the North American Philips Company early last year, has now been appointed chief engineer of Philips Electrical "to advise the managing director on all technical matters." He is also retaining his American connection. Prior to going to America in May, 1946, he was general manager of the Electronics Division of Murphy Radio.



DR. R. C. G. WILLIAMS—chief engineer, Philips Electrical.

OBITUARY

We regret to record the death of Sir Allan Powell, G.B.E., at the age of 68, on January 24th. He was chairman of the B.B.C. Board of Governors from 1939-1946. Prior to his B.B.C. appointment he held many administrative posts in national and local government.

IN BRIEF

B.B.C. Television O.B. Unit.—We were misinformed regarding the television O.B. equipment being supplied to the B.B.C. by Pye, to which reference was made in our January issue. The equipment is limited to that which produces the video signal and does not include any radio equipment. It also makes no provision for the transmission of the sound channel.

Monopolistic.—The arguments which

led the Post Office to favour a monopolistic broadcasting organization in this country, together with the relevant matter which preceded the establishment of the B.B.C., were set out in an informative article by R. H. Coase in the August, 1947, issue of *Economica*, issued by the London School of Economics. Copies of the journal are obtainable from the London School of Economics, Houghton Street, Aldwych, London, W.C.2, price 5s.

Pictorial Record.—To mark the silver jubilee of British broadcasting the B.B.C. has issued an illustrated booklet covering the period 1922-1947. The price of this 48-page booklet, which includes 130 photographs, is 2s.

B.B.C. Research.—A country mansion at Kingswood, Surrey, has been acquired by the B.B.C. for use as an engineering research station.

Ideal Home.—Radio and television will again be featured at the *Daily Mail* Ideal Home Exhibition which celebrates its silver jubilee at Olympia in March. The exhibition opens to the public at 5 p.m. on March 2nd; thereafter from 9.30 a.m. to 9.30 p.m. each weekday till March 25th.

Ship-to-Shore.—More than 285,000 ships communicated with Post Office coast stations during 1947 and nearly 658,000 radio telegrams were exchanged between vessels and these stations.

Waste Paper.—A drive to collect an additional 100,000 tons of waste paper by July is announced by the Waste-Paper Recovery Association. This quantity is equivalent to a saving of 10 million dollars. The Association stresses that waste-paper salvage is even more important now owing to currency shortages than during the war.

Aeronautical.—Under a special air mail subscription arrangement our

World of Wireless—

associated journal *Flight* can be in the hands of readers in the United States and Canada within 24 hours of publication. The special subscription rate for Canada and U.S.A. is £4 (\$16) for six months, which may be remitted to British Publications Inc., 150, East 35th Street, New York, N.Y.

INDUSTRIAL NEWS

B.E.T.R.O. announces that in response to a number of enquiries it is undertaking an "on the spot" survey of market data in Turkey, Iraq and Iran. The services of Wilfred Sloane, who is leaving for the Middle East in March, are available to all exporters. Further information can be obtained from the Secretary, British Export Trade Research Organization, 48, Dover Street, London, W.1.

B.V.A.—With the resignation of J. R. Hughes from the British Radio Valve Manufacturers' Association, the



J. R. HUGHES—from B.V.A. to Hivac.

post of technical secretary has lapsed, but P. A. Fleming has been appointed technical assistant to W. R. West, the secretary.

Radio & Television Trade Federation is the name of a new organization which has been formed by the Radio and Television Retailers' Association and is registered as a trade union. Details of membership, which is open to retailers, wholesalers and manufacturers, are available from the secretary, H. A. Curtis, 18, Woburn Square, London, W.C.1. The chairman is F. J. Smith.

A.I.S. Products, formerly manufactured by Aligned Instrument Services of 1, Colworth Road, Leytonstone, London, E.11, will in future be made and distributed by the London Television Co., Ltd., 694, Lea Bridge Road, Leyton, London, E.10.

B.I.F.—This year's British Industries Fair, which is being organized by the Board of Trade, will be held simultaneously in London and Birmingham from May 3rd to 14th. The Radio Section will again be housed in Olympia, which will be open daily (except Sunday) from 9.30 a.m. to 6 p.m. Admission will be restricted to trade buyers, except on Wednesdays and Saturday, when the public will be admitted at a charge of 1s 6d. Enquiries

regarding the Fair should be addressed to the Board of Trade, Export Promotion Department, 35, Old Queen Street, London, S.W.1. (Tel.: Victoria 9040.)

Eddystone.—Stratton and Co. announce that the Eddystone communications receiver, Type 640, is no longer subject to purchase tax. The price has also been reduced and is now £39 10s.

E.M.I. Relays (Hayes), Limited, is the title of a new company formed by Electric and Musical Industries to provide a four-programme radio-relay service to residents in the area adjacent to the company's factory at Hayes, Middlesex.

Thrush Radio and Electrical Industries have moved to 37, Finchley Lane, Hendon, London, N.W.4 (Tel.: Hendon 6255).

Garrard.—The London sales office of the Garrard Engineering and Manufacturing Company has been moved from 17, Grafton Street, W.1, to 68-70, Finsbury Pavement, E.C.1 (Tel.: Metropolitan 8927). The service and spares department of the company is now at Okus Road, Swindon (Tel.: Swindon 3405).

Murex, Ltd., of Rainham, Essex, announce that they are manufacturing titanium hydride, with a titanium content of 98 per cent., which was previously imported from the United States. It is used in powder metallurgy and one of its applications is in the production of micro-wave valves.

MEETINGS

Institution of Electrical Engineers

Radio Section.—"The Testing of Communication-type Radio Receivers," by W. J. Bray, M.Sc. (Eng.), and W. R. H. Lowry, B.Sc., on March 3rd. "Automatic Telegraphy and Single-Side-Band Working," by A. Cook, B.Sc., on March 9th.

"Three-Dimensional Cathode-Ray Tube Displays," by E. Parker, M.A., and P. R. Wallis, B.Sc. (Eng.), on March 24th.

All these meetings will be held at Savoy Place, London, W.C.2, at 5.30.

Cambridge Radio Group.—Discussion on "Sound-Recording Methods," on March 1st at the Cavendish Laboratory at 8.15 (joint meeting with the Cambridge University Wireless Society).

"Electronic Calculating Machines," by Professor D. R. Hartree, M.A., Ph.D., F.R.S., on March 6th at the Cavendish Laboratory at 8.15.

Mersey and North Wales Centre.—Faraday Lecture on "Electricity and Everyman," by P. Dunsheath, C.B.E., M.A., D.Sc. (Eng.), on March 22nd at the Philharmonic Hall, Hope Street, Liverpool.

North-Eastern Radio and Measurements Group.—"Activities and Equipment of Industrial Electronics Laboratory," by G. A. Hickling, on March 1st, at King's College, Newcastle-on-Tyne, at 6.15.

North Midland Centre.—Dr. Dunsheath's Faraday Lecture, on March 9th, at the Albert Hall, Leeds, at 7.

North-Western Centre.—Dr. Dunsheath's Faraday Lecture, on March 24th, at the Great Hall, Manchester College of Technology, at 7.30.

Northern Ireland Centre.—Dr. Duns-

heath's Faraday Lecture on March 19th, at the Central Hall, College of Technology, Belfast, at 7.30.

South Midland Centre.—"Speech Communication under Conditions of Deafness or Loud Noise," by W. G. Radley, C.B.E., Ph.D. (Eng.), on March 1st, at the Imperial Hotel, Birmingham, at 6 (joint meeting with the Institution of Post Office Electrical Engineers).

South Midland Radio Group.—"Closed Cycle Control Systems," by Professor A. Tustin, M.Sc., on March 22nd, at the James Watt Memorial Institute, Great Charles Street, Birmingham, at 6 (joint meeting with the South Midland Centre).

Irish Branch.—Dr. Dunsheath's Faraday Lecture on March 18th, at Trinity College, Dublin, at 6 p.m.

British Institution of Radio Engineers

London Section.—"The Principles and Practice of Panoramic Display," by D. W. Thomasson, on March 11th, at the London School of Hygiene and Tropical Medicine, Keppel Street (Gower Street), W.C.1, at 6.

Midland Section.—"Methods of Measuring Insertion Loss, Phase Shift and Time Delay of Transmission Networks," by N. E. Head, on March 19th, at the Technical College, The Butts, Coventry, at 6.30.

North-Eastern Section.—"The Calculation of Electrode Temperatures in the Radio Valve," by I. A. Harris, on March 10th, at Neville Hall, Westgate Road, Newcastle-on-Tyne, at 6.

North-Western Section.—"Some Aspects of Moderate Precision Temperature Control in Communication Engineering," by M. P. Johnson, B.A.Sc., on March 11th, in the Reynolds Hall, College of Technology, Sackville Street, Manchester, at 6.45.

Scottish Section.—"The Development of Radiology," by Angus Campbell, M.B., C.L.B., D.R., on March 17th, at the Heriot-Watt College, Edinburgh, 1, at 6.30.

British Sound Recording Association

London Meetings.—"Loudspeakers—With Particular Reference to High-Fidelity Monitoring Reproducers," by D. E. L. Shorter, on March 11th, at 5.45 (joint meeting with the Acoustics Group of the Physical Society).

"High Quality Disk Recording," by W. S. Barrell, on March 25th, at 7.

Both these meetings will be held at the Royal Society of Arts, John Adam Street, Strand, W.C.2.

Radio Society of Great Britain

London Meeting.—"The Practical Use of Frequency Modulation on Amateur Frequencies," by D. N. Corfield, D.L.C. (G5CD), on March 12th, at the I.E.E., Savoy Place, London, W.C.2, at 6.30.

British Kinematograph Society

Society Meeting.—"Phase Modulation Principles Applied to Sound Recording," by J. A. Sargrove, D. A. Bell, and N. Leever, B.Sc., on March 10th, at the Gaumont-British Theatre, Film House, Wardour Street, London, W.1, at 7.15.

Electrical Trades Union

London Meeting.—Open discussion on "Valve Standardization and Valve Developments," on March 24th, at Room 11, The Friends' House, Euston Road, London, N.W.1, at 7 p.m.

F.M. Reception

Comparison Tests Between Phase Discriminator and Ratio Detectors

By D. MAURICE and R. J. H. SLAUGHTER

(Engineering Research Dept., B.B.C.)

IN domestic broadcast receivers the cost of each portion must be carefully studied because for such a competitive market it is not possible to design to a perfect performance specification but to give the best possible "value for money." This article proposes to discuss one portion of a F.M. receiver wherein a recent development promises to enable a reduction of cost to be effected without serious loss of desirable properties.

The demodulator portion of a F.M. receiver is often termed "discriminator." Its function is to convert frequency-modulated waves into equivalent amplitude-modulated waves and to detect the latter in the usual fashion with diode valves or other suitable non-linear resistances. In many discriminators, including the conventional balanced phase discriminator due to S. W. Seeley (US Patent 2121103, British Patent 489094), the form taken is that of an L, C, M and R network included in the anode circuit of a R.F. pentode valve used with low screen and anode voltages and no grid bias in order to act as an amplitude limiter. With conventional phase discriminators an amplitude limiter is essential as the former are sensitive to undesired amplitude modulation of the signal voltage. The ratio detector, also due to Seeley, is an adaptation of the balanced phase discriminator rendered unresponsive to amplitude modulation. It will be assumed in what follows that the mode of operation of the balanced phase discriminator is known to the reader.*

Fig. 1 is a simplified circuit diagram of a ratio detector. L_1 is the primary coil and L_2 are the secondary windings of the usual balanced phase discriminator. It will be noted that the two diode valves are in series aiding instead of in series opposition, as they would have been in a phase discriminator. The diodes are

biased beyond cut-off by a centre-tapped battery of voltage V . It is well known that with no frequency modulation the signal voltage amplitudes S_1 and S_2 are equal, but when a frequency deviation is imposed upon the signal S , the two half-secondary voltages become different from one another,

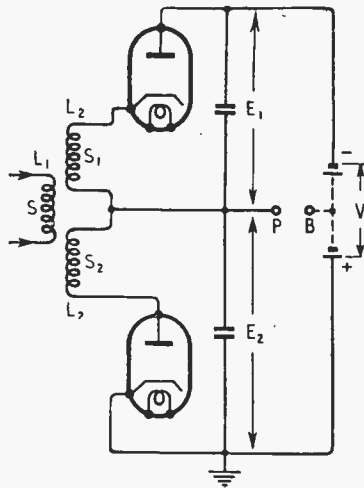

Fig. 1. Basic circuit of ratio detector.

one increasing and the other decreasing. Now suppose that some unwanted amplitude modulation is imposed upon the signal S , this becoming $S + \Delta S$. If the signal is being frequency modulated, then at some part of the modulation cycle the two half-secondary voltages will be different and in ratio

$$K = \frac{S_1 + \Delta S_1}{S_2 + \Delta S_2} = \frac{E_1 + \Delta E_1}{E_2 + \Delta E_2}$$

$$= \frac{E_1}{E_2} \cdot \frac{1 + \frac{\Delta E_1}{E_1}}{1 + \frac{\Delta E_2}{E_2}} = \frac{E_1}{E_2} \quad \dots (1)$$

because the relative amplitude modulations $\frac{\Delta E_1}{E_1}$ and $\frac{\Delta E_2}{E_2}$ are equal.

It is, however, clear from Fig. 1 that

$$E_1 + \Delta E_1 + E_2 + \Delta E_2 = V \quad (2)$$

the battery voltage.

Putting (1) into (2)

$$(E_2 + \Delta E_2)(1 + K) = V \dots (3)$$

Now the voltage V_P of the point P is

$$V_P = E_2 + \Delta E_2 \quad \dots (4)$$

and that of point B is

$$V_B = \frac{V}{2} \quad \dots (5)$$

Putting (3) into (4) and subtracting (5)

$$V_P - V_B = V \left(\frac{1}{1 + K} - \frac{1}{2} \right) \dots (6)$$

This voltage is independent of the unwanted amplitude modulation represented by ΔE_1 and ΔE_2 , and is a function of K , the ratio between the two half-secondary voltages. This ratio is, in turn, dependent on the frequency deviation imposed upon the signal at the transmitter. Thus the ratio detector does not require to be preceded by an amplitude limiter.

The output audio voltage $V_P - V_B$ is not strictly proportional to the frequency deviation of the signal, but if the ratio of deviation to carrier frequency is small, K will not differ greatly from unity and the distortion will be negligible.

It can be shown that if the same R.F. pentode, operating under identical conditions, is used to feed the two types (phase and ratio) of discriminator, the sensitivity in audio volts output per kc/s deviation per pentode grid volt of the ratio detector is one quarter that of the balanced phase discriminator. Here we reach the crux of the matter because the R.F. pentode used as the discriminator feed valve is *not* used in the same conditions for the two cases. As has been stated, the phase discriminator must be preceded by an amplitude limiter and usually this is formed by the discriminator feed valve.

* See for example *Wireless World*, April and May, 1943.

F.M. Reception—

This valve thus operates in a condition of very low mutual conductance—of the order of a twenty-fifth or less of the normal operating slope. Now the ratio

whether the distortion is, in fact, negligible, and whether it really does suppress impulsive interference as well as does an amplitude limiter. The following tests will show that, in fact, it is

input signal required to operate the amplitude limiter was about $300 \mu\text{V}$. The receivers had the following circuit: one R.F. stage tunable over a small band around 90 Mc/s and having a high-slope low-noise pentode valve, a double triode valve used as a super-heterodyne oscillator and frequency changer, an intermediate-frequency amplifying stage employing the same type of valve as the R.F. stage, a limiter stage using the same valve as the I.F. and R.F. stages and having the balanced phase discriminator in its anode circuit, a double diode balanced demodulator, the 50 $\mu\text{-sec.}$ de-emphasis circuit, a triode A.F. amplifier and a pentode A.F. output valve and loud-speaker. In one of the two receivers the phase discriminator was so modified that it became a ratio detector. The circuit of the phase discriminator in the unmodified receiver is shown in Fig. 2 whilst that of the ratio detector in the modified receiver is shown in Fig. 3. It will be noted that the battery of voltage V in Fig. 1 has become a condenser

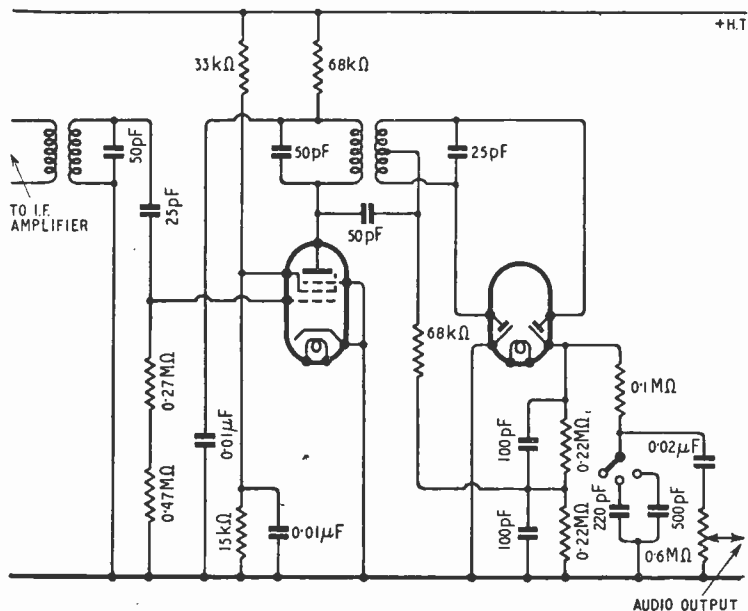

Fig. 2. Details of phase discriminator circuit.

Fig. 3. Circuit of ratio detector used in tests.

detector, not requiring an amplitude limiter, may be fed from a valve working in normal operating conditions so that although its circuit sensitivity is a quarter of that of the phase discriminator, its overall sensitivity is of the order of six times ($25/4$) this. This increase in sensitivity, while useful, is unfortunately scarcely enough to allow for the elimination of one of the I.F. amplifying stages preceding the ratio detector. Thus an actual economy in number of valves and amplifier stage is not necessarily achieved, though this depends on the actual overall gain required from the receiver. What can be definitely stated is that the wide-band F.M. receiver incorporating a balanced phase discriminator would undergo an increase in sensitivity by the replacement of its discriminator with a ratio detector.

The desirability of using a ratio detector thus depends on

a usable and satisfactory device.

Two initially identical 90 Mc/s F.M. receivers suitable for $\pm 75\text{kc/s}$ deviation and 50 microsecond pre-emphasis were employed. They were not very sensitive and were built on normal domestic broadcast receiver lines. The

C_3 shunted by a resistor R_1 in Fig. 3. This condenser becomes charged by the rectification of the signal voltage by the two diodes in series aiding. The time constant C_3R_1 is made longer than the reciprocal of the lowest audio angular frequency so that

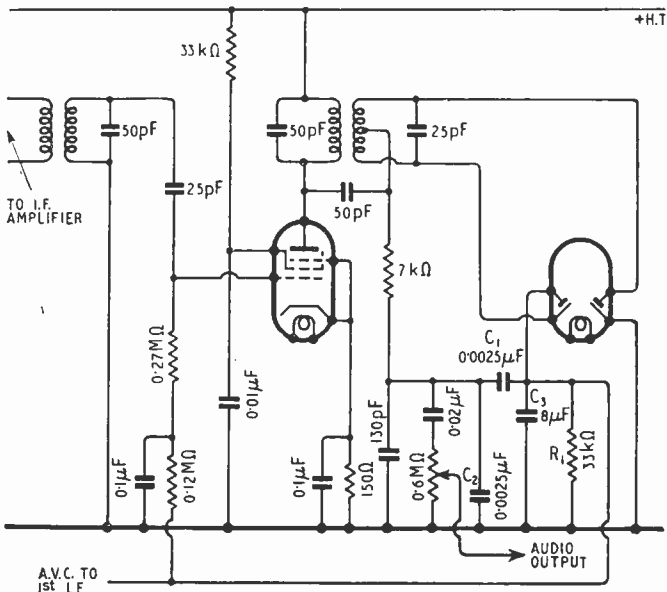

audio voltage variations do not alter this "battery" voltage. Of course, slow variations in signal strength will alter it. The 50 μ -sec. de-emphasis time constant was determined experimentally, having fixed R_1 and C_3 , by varying the common value of C_1 and C_2 .

Suppression of Impulsive Interference

Fig. 4 shows a schematic diagram of the test layout. A 90-Mc/s half-wave dipole was connected to a two-pole two-position switch so that either receiver could be connected to it. Ganged with this switch was an identical one which connected the output from the receiver on the dipole, to an audio-frequency attenuator followed by an A.F. amplifier and loudspeaker. In parallel with the dipole and switch was connected a balanced-to-unbalanced transformer, to the unbalanced side of which was connected a V.H.F., F.M. standard signal generator. A spark generator of impulsive interference was arranged to radiate at some distance from the 90-Mc/s receiving dipole.

The test procedure was as follows: The F.M. signal generator was arranged to produce a 40% frequency modulated signal of 5 mV at a carrier frequency of about 90 Mc/s. The two receivers were, in turn, tuned to this signal and their audio gain controls adjusted for equality of aural loudspeaker sound output. The signal modulation was removed and the spark generator switched on. The audio impulsive noise output from the two receivers was compared. The phase discriminator receiver was slightly better than the ratio detector receiver and so the former was used as reference level. When switching from "phase" to "ratio" the A.F. attenuator was adjusted to equate the output from the latter to that from the former. By progressively reducing the signal strength from 5 mV downwards the curves in Fig. 5 were produced. It may be seen from this figure that except for very small signal strengths the ratio detector is about 2 db worse (noisier) than the phase discriminator.

It may be remarked that this

test was a static one, in that it was undertaken during the absence of modulation. This, however, is a very practical condition because impulsive interference which is noticeably disturbing during modulation is still more so during quiescent periods, because the very considerable masking of noise by programme is absent during such times. Tests not described here indicated that the ratio discriminator maintained its impulse suppressing properties for a mis-tuned signal better than a single limiter and phase dis-

at which fluctuation noise level was so high as to preclude further testing. No appreciable difference in quality of reproduction was observed between the two receivers for any signal input level. It was noticed, however, that the ratio detector receiver was somewhat less sensitive than the one employing the phase discriminator. The explanation is that for ease and rapidity of execution of the investigation, the general impedance level of the ratio detector was made about ten times lower than that to which the unmodified

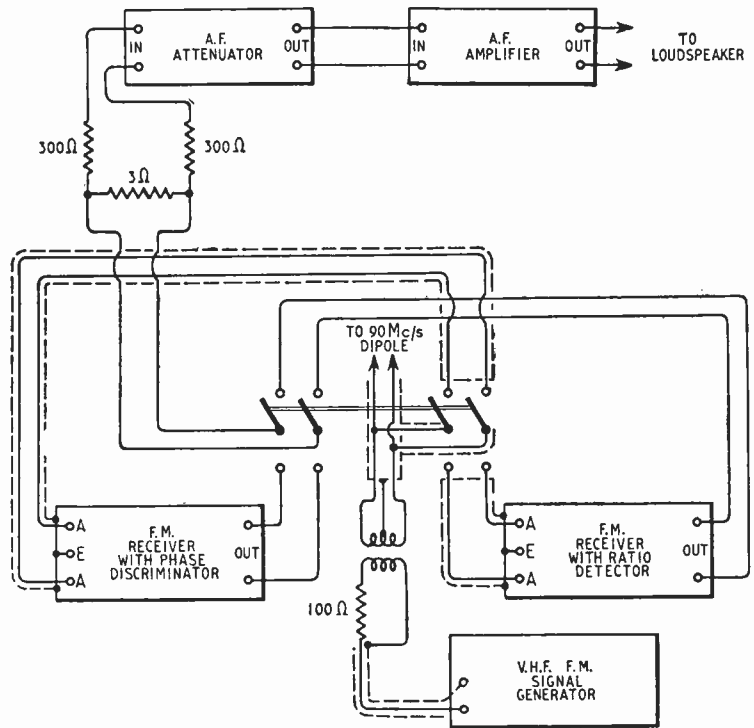

Fig. 4. Schematic arrangement of test.

criminator combination. The mis-tuned signal should be taken as representative of a properly tuned F.M. signal during some portion of the audio modulation cycle.

For comparing quality of reproduction the same layout as shown in Fig. 4 was used. Of course the spark generator was not employed. The signal generator was fitted with an audio 50 μ -sec. pre-emphasis circuit. The programme quality of the two receiver outputs was compared for values of input signal strength from .5 mV. down to that value

receiver phase discriminator was designed. It may be seen from Fig. 2 that the total diode load is 440 k Ω whereas in Fig. 3 this is 33 k Ω . This reduced impedance level naturally results in a very considerable loss of gain, which was accepted for the purpose of these tests.

For the ratio detector it has been claimed that:

(1). No limiter stage is required in front of the ratio detector, hence there is no threshold at which interference due to unwanted A.M. on the signal becomes

F.M. Reception—

considerable, as happens in the more conventional limiter-cum-phase discriminator combination. This is, in fact, true, though the receiver output will be more dependent upon signal strength than in a receiver incorporating a limiter.

(2). Although the ratio detector is, in itself, less sensitive than the phase discriminator, this is counterbalanced by the fact that no gain need be sacrificed in a limiter stage. This was also found to be the case. A net gain of 16 db is achievable.

(3). A convenient and effective

Fig. 5. Comparison of noise levels from ratio detector (A) and balanced phase discriminator (B)

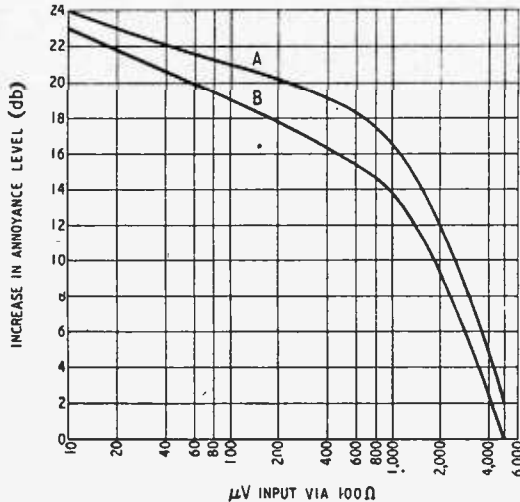

automatic gain control voltage is readily available. This is true but not very relevant as A.G.C. is not really necessary in a F.M. receiver if all grid circuit discharge time constants are kept low, (below 2 μ -sec). However A.G.C. can be used with advantage in a ratio detector receiver.

(4). Tuning for minimum noise is less critical than with the phase discriminator scheme. It was found, however, that in practice there is very little difference between the two schemes because tuning for minimum distortion seemed slightly more

difficult than the conventional scheme.

REFERENCES

- "The Ratio Detector," by S. W. Seeley and J. Avins. *R.C.A. Review*, June, 1947.
- "F.M. Ratio Detectors," by R. G. Peters. *Communications*, November, 1945.
- "Ratio Discriminator is Insensitive to A.M." *Electronic Industries*, November, 1945.

News from the Clubs

Barnet Radio Group now meets on the first Saturday after the 10th of each month at 7.30 at Bunny's Restaurant, 16, Station Road, New Barnet, Herts.

Birmingham.—At the next meeting of the Slade Radio Society on March 5th at 8.0 at the Parochial Hall, Broomfield Road, Slade Road, Edington, Birmingham, 23, M. Moseley, of the G.E.C. Radio Works, Coventry, will give an informal lecture on "An Introduction to Television."

Birmingham.—Meetings of the Birmingham and District Short-Wave Society are now held on alternate Mondays at 7.45 at the Friends' Institute, 220, Moseley Road, Birmingham, 12.

Cannock.—Meetings of the Cannock Chase Radio Society recommenced at the beginning of the year and will in future be held on the first and third Tuesdays of each month at the Black Horse Hotel, Mill Street, Cannock, Staffs

Farnborough.—The R.A.E. and Farnborough District Amateur Radio Society, which was formed just over

a year ago, now has a membership of over 50. Meetings are held on alternate Mondays at 7.30 in the Common Room, R.A.E. Assembly Hall, Farnborough, Hants. The next meeting is on March 1st.

Leeds.—The name of the Leeds Radio and Television Society has been changed to Leeds and District Amateur Radio Society, with headquarters at Swathmore Settlement, Woodhouse Square, Leeds. Meetings are held on Fridays at 7.0.

Leicester.—The television sub-section of the Leicester Radio Society meets on alternate Tuesdays to the general meeting of the club. All meetings are held at the Charles Street United Baptist Church at 7.30. The secretary of the sub-section is E. Fowkes, 157, Staveley Road, Leicester.

London.—The City of London Phonograph and Radio Society, which meets at 6.30 on the first Thursday of the month at "The Flying Horse," 52, Wilson Street, E.C.2, is concerned mainly with recording and reproduction. The re-creation of old pre-electric recordings—hill and dale cylinders and

discs as well as lateral cut discs—is undertaken by the society.

Merseyside.—To co-ordinate the activities of the Liverpool and District Short-Wave Club and the recently formed Merseyside Radio Society, the Merseyside Amateur Radio Committee has been elected. A monthly news sheet is being issued by the committee. Meetings of the L.D.S.W.C. are held on Tuesdays at 7.30 at St. Barnabas Hall, Penny Lane, Liverpool, 17. The M.R.S. meets at 2.30 on alternate Saturdays at 29, Derby Lane, Old Swan, Liverpool, 13. Tuition for the amateur licence examination is given on Wednesdays and Fridays at 7.30.

Northampton.—The recently formed Northampton Radio Society meets fortnightly at the Northampton College of Technology.

Petersfield.—Readers in the Petersfield (Hants) district who are interested in the formation of a club are invited to communicate with C. Watts, Hylton House, St. Mary's Road, Liss, Hants.

Romford.—Negotiations are proceeding for the conversion of a surface air-raid shelter by the Romford and District Amateur Radio Society for the installation of the club transmitter.

Salisbury.—Meetings of the Salisbury and District Short-Wave Club are now held on Tuesdays at 8.45 at the club's new premises, Hut 64, School of Chemical Warfare, Winterbourne Gunner, near Salisbury, Wilts.

Swindon.—Meetings of the Swindon and District Short-Wave Society are held on alternate Saturdays at 7.30 at Clifton Street School, Swindon, Wilts.

Names and addresses of club secretaries are given in the directory on page 100.

MANUFACTURERS' LITERATURE

Illustrated catalogue of E.R.D. Sound Reproducers (radio-gramophones) from A. N. Clements, 99A, Charing Cross Road, London, W.C.2.

Leaflet of ammeters and voltmeters from Pifco, Watling Street, Manchester, 4.

Descriptive leaflet of television components (transformers, focus and scanning coils) from the Plessey Company, Ilford, Essex.

Catalogue of selenium rectifiers (Bulletin SRGI) from Standard Telephones and Cables (Rectifier Division), Oakleigh Road, New Southgate, London, N.11.

Technical booklet, "Thermostatic Binmetals," from the Telegraph Construction and Maintenance Co., 22, Old Broad Street, London, E.C.2.

List of radio and gramophone equipment in kit form, from the Teleradio Co., 157, Fore Street, London, N.18.

"Technical Information on the Dry Accumulator" from Varley Dry Accumulators, By-pass Road, Barking, Essex.

LOAD — or Burden,

In More Senses Than One

By "CATHODE RAY"

ONE of my hobbies, as readers may have noticed, is criticizing the language of radio. There are so many words and uses of words that seem unnecessarily confusing, if not actually wrong. Radio is not an easy subject, and there is a great deal of it, so it seems a pity that the utmost care is not taken to keep the path of the learner clear from unnecessary obstacles. I suppose the survivors in the struggle for knowledge soon get used to the anomalies of technical language and forget how baffling they were at first. But on reading books and papers on radio, especially those claiming to be for novices, I often wonder what such readers make of some of the statements therein. Sometimes I don't need to wonder—the strangest misunderstandings, traceable to technical terms, come to light in conversation and correspondence. An example that occurs to me at the moment was an inquiry about how to obtain a speech coil. The writer was satisfied with the reproduction of music from his loud speaker, but not with speech, which he wished to improve!

"Load" is a common non-technical word, so writers rarely consider it necessary to explain its technical meaning, still less the several technical meanings that are given to it. Since it is quite frequently used with different meanings in referring to the same subject—say an amplifier—the risk of confusion is considerable.

English Usage

Non-technically, I suppose the meaning of a "load" is a burden or a weight to be carried. If the load is excessive in relation to the carrier there is a risk of breakdown; as for example in the fracture of a camel's back. An inquiry as to whether the load consisted of the material carried or the uncomfortable sensation of pressure induced thereby would probably be dismissed as too metaphysical, but in technical circles the question is of practical importance, as will be seen later. Even in general talk the word is

used figuratively, as in "a load of care." And that loads are not always deemed unacceptable is shown by the cheerful invitation to "get a load of this!"

It is an obvious extension of the literal idea of a personal or animal load to apply it to what is borne by a mechanical device such as a truck or bridge; and the possibility of breakdown in the event of an overload is none the less certain because the mechanical carrier is generally unable to express its feelings so pointedly. So the designers or constructors of such devices generally specify a "full load," which is exceeded only at the owner's risk. A further extension of the idea, from a weight to a torque, and hence to a power, is also perfectly natural and holds good for engines and motors. In particular, if the turning of an electric motor is resisted much beyond the limit corresponding to full load (or as a specified overload), the excessive current taken may burn it out, or it may "pull out" and come to a standstill, or both. This application to mechanical power is evidently considered so obvious that it is not even mentioned in the British Standard Glossary of Terms used in Electrical Engineering (B.S. 205: Part I: 1943; 1615) which in its definition of load refers only to power in electrical form. In the last year or two this particular technical meaning has become only too familiar to the general public as a result of certain operations by the electrical supply authorities. But even the discomforts (to put it mildly) of load-shedding are less to be dreaded than the results of an overload which is not shed.

The supply engineer's load, then, is measurable in kw, or (more correctly in A.C. systems) kVA. The installation people who do the wiring, use "load" in a slightly different sense. Drawing an excessive load of power is certainly not likely to subject the wiring to too high a voltage: so

load in this connection is synonymous with "current," which must be kept within limits if there is not to be overheating and excessive voltage drop. The transmission engineer's load is usually stated in amps.

You may have noticed that so far the engineer's idea of load corresponds closely to the physical effect of a burden, such as its gravitational pressure, which is less likely to be in the mind of the non-technical person than the visible cause—the 10⁷+1 Egyptian straws or the "40 hommes ou 8 chevaux." It is true that "load" is quite often used also in the latter sense in electrical engineering, to refer to a lamp or an electric fire or even a town, but this is considered by purists as verging on technical jargon rather than precise terminology. Either way it is all closely in line with the proverbial camel and other popular ideas about loads in general.

Radio Loads

Coming now to our own branch, what does the British Standard Glossary of Terms used in Telecommunication say? The answer is—nothing. As regards just "load," at least. There is a definition of "anode load" and one of "loading," of which more anon. If, in the absence of other guidance, we were to follow the quite sensible practice of general electrical engineers, it would seem natural to look to the generators of audio and radio power for a meaning to give to "load." But it is not quite so simple. As in many other respects, there is a different emphasis in Telecommunication (or whatever you like to call the rather ill-defined subject to which this journal is devoted). With an electrical power supply connected, a breakdown of something by overheating is normally the only limit to the power that can be drawn. Up

to "full load"—and far beyond it—the impedance of the power source and its connections is far too small to restrict the flow. Hence the need for fuses or circuit-breakers. It would be a sign of something radically wrong if no more than, say, 100 watts could be drawn from a live socket no matter what was connected. Normally, the lower the resistance or impedance of the thing connected—the thing that is often called the "load" in one sense—the greater is the current and (because the voltage remains reasonably constant) the power—which is the "load" in a different but related sense.

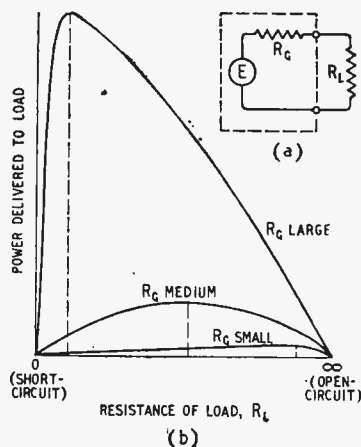

Showing how for a given generator voltage E , the power depends on the load resistance R_L .

In radio the impedance of the source of supply is practically always important. The power drawn cannot rise without limit as the impedance of the load is lowered; it reaches a maximum, beyond which the further increase in current is more than offset by the reduction in voltage due to the drop in the source impedance. At this stage the books usually prove the well-known proposition that maximum power is obtained when the resistance of the load is equal to that of the source (and the reactance, if any, is equal and opposite). In the diagram, where (a) represents a generator of voltage E with a resistance R_G , feeding a load R_L , the way the power in the load depends on the resistance of the load is shown at b for three different generator resistances. In each case the dotted

line marks the condition where $R_G = R_L$. If the generator resistance were *very* low (as it is with a public power supply), then the curve would have its peak close to the left-hand margin, and high enough to raise the roof. In fact, anywhere near the peak would be of no practical interest because it would be beyond the region of blown fuses.

But the possibility of "overloading" a radio or audio oscillator or other source, in the sense of overheating it by drawing too many amps, or kilowatts, seldom exists, because the current is limited by the source impedance, and is generally not destructively large even if the output terminals are dead shorted. In some cases there will be some sort of trouble, such as valves overheating, but that does not depend simply on the amount of power drawn. In fact, there may be trouble (such as flashing over) if no power at all is drawn, by leaving the output terminals open-circuited. The important thing is to connect the right impedance. So "load," in radio and allied arts, is generally the impedance of the thing into which the power goes, and is measured in ohms. The B.S. definition of "anode load," for example, is "the total external impedance included in the anode circuit of a valve." "Overloading" in this connection hardly makes sense. If 2,000 ohms is the correct load for an amplifier, what would an overload be? Not 20,000 ohms, presumably. Substituting 200 ohms would also cause less power to be delivered, and although more power might be dissipated in the amplifier it would scarcely be enough to damage it.

Yet amplifiers are often said to be—and unfortunately often are—overloaded. This does not refer to the load (in the sense just described) at all. Hence there is a possibility of confusion in the learner's mind. Such overloading may in exceptional cases damage the equipment—though even then not generally in the same way as overloading a power supply—but the main damage is generally to the listener's peace of mind. The result, in a word, is *distortion*. And the cause is an excessive *input* of signal. Yet it is not usual to call this input, which overloads the amplifier, a *load*. But one

can say that the amplifier is fully loaded by a signal of so many volts at the input.

Different Meanings

Telephone line engineers mean something still different when they say a line is loaded. They are saying that it has inductance distributed along it to improve its transmission characteristics. The meaning of a line being loaded, then, depends on whether it is a telephone line or a power line.

To finish this tale, let us create a situation in which the different meanings occur together. A certain imaginary broadcasting station is a supply-mains load of 200 kw, and slightly overloads the supply line, which was designed for 180 kw. The cooling pump is driven by a motor which normally runs at about half its rated full load, viz., $1\frac{1}{2}$ h.p. The optimum R.F. load resistance for the transmitter, at the point of aerial feeder connection, is 300 ohms. The transmitter is modulated by an audio signal received via a loaded telephone line, and if the level of the signal is carelessly adjusted the final modulator stage overloads, with resulting distortion.

Is all that quite intelligible (though perhaps not very coherent!)? Then you have probably grasped the various shades of meaning of "load" and its derivatives.

MICROWAVE TECHNIQUE

WITHIN the limitations of 50 pages this booklet succeeds in giving a general picture of modern microwave technique. It discusses the generation, propagation and reception of these extra-high frequencies. The very difficult subject of wave guides is dealt with in an easily understandable way and without algebraical aids.

In the chapter on aerials the reader will find himself on familiar ground, but not for long, as radiating horns and other special types soon appear on the scene. Finally, there is a chapter on the very important subject of microwave measurement.

The booklet, which is well illustrated, costs 2s (by post, 2s 3d) and is published by the Incorporated Radio Society of Great Britain, New Ruskin House, Little Russell Street, London, W.C.2. The authors are J. H. Shankland and E. D. Hart.

Societies and Clubs

List of Radio Groups in the British Isles

IN the following list, arranged in alphabetical order under towns, the name of the club, and in some cases the club call sign, is followed by that of the secretary, from whom details of the society's activities may be obtained. Clubs which are affiliated to the Radio Society of Great Britain are indicated by an asterisk. The list has been compiled from details supplied by the secretaries. We shall be pleased to receive details from the secretaries of active societies which may have been inadvertently omitted from this list.

ABERDEEN

Aberdeen Amateur Radio Society (GM3BSQ).—A. D. J. Westland, GM3BQU, 17, Beaconsfield Place, Aberdeen.

ASHTON-UNDER-LYNE

Ashton-under-Lyne and District Amateur Society (G3BND).—N. H. Brown, 63, Corporation Road, Audenshaw, Nr. Manchester, Lancs.

BASINGSTOKE

Basingstoke and District Amateur Radio Society.—L. S. Adams, 16, Brambls Drive, Basingstoke, Hants.

BATH

Admiralty Electronics Society*† (G3BPU).—D. Houston, D.E.E. Dept., Admiralty, Bath, Som.

BELFAST

City of Belfast Y.M.C.A. Radio Club* (GI6YM).—J. H. Brooks, GI3ALT, 6, Fitzroy Avenue, Belfast, N. Ireland.

BIRKENHEAD

Wirral Amateur Radio Society.—B. O'Brien, G2AMV, 26, Coombe Road, Irby, Heswall, Ches.

BIRMINGHAM

Birmingham and District Short-Wave Society.—N. Shirley, 14, Manor Road, Stechford, Birmingham, 9, Warwick.

Kynoch Radio and Television Society*.—G. E. Nicholls, 20, Merrions Close, Great Bar, Birmingham, 22a, Warwick.

Midland Amateur Radio Society*.—W. J. Vincent, G401, 342, Warwick Road, Solihull, Birmingham, Warwick.

Slade Radio Society*.—C. N. Smart, 110, Woolmore Road, Erdington, Birmingham, 23, Warwick.

BLACKPOOL

Blackpool and Fylde Amateur Radio Society.—H. D. Ashworth, 5, Albion Avenue, Blackpool, Lancs.

BOGNOR

West Sussex Short-Wave and Television Society.—R. D. Holland, Maybury, Aldwick Gardens, Bognor Regis, Sussex.

BOVINGDON

Bovingdon Airport Club, Amateur Radio Section.—J. D. Lord, Police Station, Bovingdon, Herts.

BRADFORD

Bradford Amateur Radio Society*.—W. S. Sykes, G2DJS, 287, Poplar Grove, Great Horton, Bradford, W. Riding.

BRIGHTON

Brighton and Hove Group, R.S.G.B.*.—G. Johnson, 3, Greenfield Crescent, Patcham, Brighton, 6, Sussex.

BURNHAM

Burnham and Highbridge Amateur Radio Society.—A. D. Taylor, G8PG, 81, Burnham Road, Highbridge, Somerset.

CAMBRIDGE

Cambridge University Wireless Society* (G6UW).—G. N. S. Taylor, Trinity College, Cambridge.

CANNOCK

Cannock Chase Radio Society.—C. J. Morris, D.F.M., G3ABG, 66, Allport Road, Cannock, Staffs.

CARLISLE

Carlisle Amateur Radio Society.—J. Ostle, G2DYV, 2, Outgang, Aspatria, Carlisle, Cumberland.

CATTERICK

Catterick Amateur Radio Club (G3CIO).—Cpl. A. Hall, 2nd Sqn., 1st Trg. Regt., Royal Signals, Catterick Camp, Yorks.

CHATHAM

Medway Amateur Receiving and Transmitting Society* (G2FJA).—S. A. C. Howell, G5EN, 39, Broadway, Gillingham, Kent.

CHELTENHAM

Cheltenham and District Amateur Radio Society*.—H. Brislin, 52, Cleevemount Road, Cheltenham, Glos.

COVENTRY

Coventry Amateur Radio Society* (G2ASF).—J. W. Swinnerton, 118, Moor Street, Coventry, Warwick.

CRANWELL

Royal Air Force Amateur Radio Society* (G8FC).—N. Davis, No. 1 Radio School, R.A.F., Cranwell, Lincs.

DONCASTER

Doncaster and District Amateur Radio Society* (G3CBM).—H. Flintham, 50, Burton Avenue, Balby, Doncaster, West Riding.

EASTBOURNE

Eastbourne and District Group, R.S.G.B.*—E. F. Nugent, G2FTS, 12, St. Anthony's Avenue, Eastbourne, Sussex.

EXETER

Exeter and District Radio Society.—E. G. Wheatecroft, 34, Lethbridge Road, St. Loyes, Exeter, Devon.

FARNBOROUGH

R.A.E. and Farnborough District Amateur Radio Society*.—R. J. Corps, B.Sc., Armament Department, R.A.E., Farnborough, Hants.

GLASGOW

"Hi-Q Club"§.—J. D. Gillies, 3, Berridale Avenue, Glasgow, S.4.

GLOUCESTER

Gloucester and District Amateur Radio Society.—J. W. Dean, G2AZT, 100, Stanley Road, Gloucester.

GRAYS

Grays and District Amateur Radio Club*.—J. Spokes, 8, Wood View, Little Thurrock, Grays, Essex.

GRIMSBY

Grimsbay Amateur Radio Society.—R. F. Borrill, G8TZ, 115, Garden Street, Grimsby, Lincs.

GUILDFORD

Guildford and District Group.—H. C. Spencer, G6NA, 1, Shepherds Hill, Stoughton, Guildford, Surrey.

(Concluded on page 110)

The following figures are the pass figures on final test for Model QA12/P AMPLIFIER



FREQUENCY RANGE
± 0.3 db 20 — 20,000 c.p.s.
SENSITIVITY
1.5 millivolts for full output (without boosts)
15 millivolts for full output (with boosts)
BASS CONTROL RANGE
— 12 db to + 16 db at 30 c.p.s. relative to 600 c.p.s.
TREBLE CONTROL RANGE
— 30 db to + 18 db at 15,000 c.p.s. relative to 600 c.p.s.
DISTORTION CONTENT
(up to 12 watts output)
2nd Harmonic < 0.2%
3rd Harmonic < 0.3%
Higher order < 0.3%
Total < 0.4%
BACKGROUND NOISE
better than — 66 db at full gain
DAMPING FACTOR 12
INPUT IMPEDANCE 1.5 megohms
SOURCE IMPEDANCE Up to 50,000 ohms
OUTPUT IMPEDANCE 7 and 15 ohms

2262



ACOUSTICAL MANUFACTURING CO., LTD., HUNTINGDON

TEL: 361

Societies and Clubs—

- HARROGATE**
Harrogate and District Short-Wave Radio Society*.—K. B. Moore, 2a, Wayside Crescent, Harrogate, Yorks.
- JERSEY**
Jersey Radio Society.—E. Banks, GC2CNC, 7, Royal Crescent, Don Road, St. Helier, Jersey.
- LEEDS**
Leeds and District Amateur Radio Society (G3BEW).—F. Stork, 1, Brudenell View, Leeds, 6, Yorks.
- LEICESTER**
Leicester Radio Society.—O. D. Knight, 16, Berners Street, Highfields, Leicester.
- LIVERPOOL**
Liverpool and District Short-Wave Club (G3AHD).—B. G. Meaden, G3BHT, 10, Alfriston Road, West Derby, Liverpool, 12, Lancs.
- Merseyside Radio Society.**—D. F. Alder, 36, Princes Avenue, Great Crosby, Liverpool, 23, Lancs.
- LONDON AND DISTRICT**
Barnet Radio Group.—R. Walker, G6Q1, 7, Potters Lane, New Barnet, Herts.
- City of London Phonograph and Radio Society.**—R. H. Clarke, 12, Grove Road, North Finchley, N.12.
- City of London Signals Amateur Radio Club*** (G3CFN).—R.S.M. Edwards, H. A. Signal House, Atkins Road, Clapham, S.W.12.
- Gray Valley Radio Transmitting Club.**—G. Miles, G2CXO, Cotswold, Nottingham Lane, Nottingham, S.E.9.
- Edgware and District Radio Society*** (G3ASR).—R. H. Newland, G3VW, 3, Albany Court, Montrose Avenue, Edgware, Middx.
- Grafton Radio Society** (G3AFT).—W. H. C. Jennings, G2AHB, 82, Craven Park Road, N.15.
- Hounslow and District Radio Society*.**—A. H. Pottle, 11, Abinger Gardens, Isleworth, Middx.
- Ilford and District Radio Society*** (G3QU).—C. E. Lergen, 44, Trelawney Road, Barkingside, Ilford, Essex.
- International Short-Wave Club.**—A. E. Bear, 100, Adams Gardens Estate, S.E.16.
- Kingston and District Amateur Radio Society*.**—A. W. Knight, G2LP, 132, Elgar Avenue, Tolworth, Surbiton.
- London Short-Wave Club.**—R. Lisney, 4, Ongar Road, S.W.6.
- North Kent Radio Society*.**—J. L. Bowes, G4MB, 20, Broomfield Road, Bexley Heath, Kent.
- North-West Kent Amateur Radio Society*.**—B. A. M. Herbert, 18, Leamington Close, Bromley, Kent.
- Radio Society of Harrow*.**—J. F. A. Lavender, G2KA, 29, Crofts Road, Harrow, Middx.
- Romford and District Amateur Radio Society*** (G4KF).—R. C. E. Beardow, G6FT, 3, Geneva Gardens, Whalebone Lane North, Chadwell Heath, Essex.
- St. Pancras Radio Society*.**—H. Brown, 84, Blenheim Gardens, N.W.2.
- Surrey Radio Contact Club*.**—L. C. B. Blanchard, 122, St. Andrew's Road, Coulsdon, Surrey.
- Sutton and Cheam Radio Society*.**—R. G. Finch, 28, Sunnymede Avenue, Carshalton Beeches, Surrey.
- Thames Valley Amateur Radio Transmitters' Society*.**—D. R. Spearing, G3JG, 39a, High Street, Esher, Surrey.
- Walworth (Men's Institute) Radio Club.**—P. Senechal, 92, Grove Park, Camberwell, S.E.5.
- Wanstead and Woodford Radio Society** (G3BRX).—R. J. C. Broadbent, G3AAJ, 24, St. Margarets Road, Wanstead Park, -E.12.
- Watford and District Radio and Television Society*.**—J. C. Warren, 29, Market Street, Watford, Herts.
- West Middlesex Amateur Radio Club*.**—H. C. Bostock, G3BWC, 1, Grange Road, Hayes, Middx.
- LONDONDERRY**
North-West Ireland Amateur Radio Society (G13CFH).—D. R. J. Adair, G13VB, Cosy Lodge, Culmore Road, Londonderry, N. Ireland.
- LOUGHBOROUGH**
Beaumanor Amateur Radio Society (G3BMR).—E. Pethers, Beaumanor Park, Loughborough, Leicester.
- LUTON**
Luton and District Radio Society.—W. C. Green, G3QG, 158, Westmorland Avenue, Limbury, Luton, Beds.
- MANCHESTER**
Radio Controlled Models Society.—J. C. Hogg, 24, Springfield Road, Sale, Cheshire.
- Whitefield and District Radio Society.**—E. Fearn, 4, Partington Street, Newton Heath, Manchester, 10, Lancs.
- NEATH**
Neath, Port Talbot and District Amateur Radio Club.—S. Roberts, GW4NZ, 29, Chestnut Road, Cimla, Neath, Glam.
- NEWCASTLE**
North-East Amateur Transmitting Society*.—J. W. Hogarth, G3ACK, 4, Fenwick Avenue, Blyth, Northumberland.
- NORTHAMPTON**
Northampton Radio Society.—B. Sykes, 114, Wellington Road, Northampton.
- NOTTINGHAM**
Nottingham and District Radio Society.—B. H. Singleton, G3CZV, 13, Tithby Drive, Sherwood, Notts.
- Nottingham Short-Wave Club.**—W. R. Peatman, The Bungalow, Marton Road, Chilwell, Notts.
- OSWESTRY**
Oswestry and District Radio Society*.—A. D. Narraway, G2APW, Lamorna, Pant, nr. Oswestry, Salop.
- OXFORD**
Oxford and District Amateur Radio Society.—H. Worsfold, 143, Ilfley Road, Oxford.
- PENZANCE**
West Cornwall Radio Club*.—R. V. A. Allbright, G2JL, Greenacre, Lidden, Penzance, Cornwall.
- PETERBOROUGH**
Peterborough and District Radio and Scientific Society.—R. S. Snell, 15, Buckle Street, Peterborough, Northants.
- PORTSMOUTH**
South Hants Radio Transmitting Society*.—J. S. K. Stephens, G8WC, 65, Ebery Grove, Copnor, Portsmouth, Hants.
- PRESTON**
Preston Radio Society*.—J. Hamilton, G2CJH, 48, Queens Road, Preston, Lancs.
- RAMSGATE**
Thanet Amateur Radio Society.—A. J. Jeffrey, Rutland House, Lloyd Road, Broadstairs, Kent.
- READING**
Reading and District Amateur Radio Society*.—L. A. Hensford, B.E.M., G2BHS, 30, Boston Avenue, Reading, Berks.
- REDHILL**
East Surrey Radio Club.—L. Knight, G5LK, Radiome, Maderia Walk, Reigate, Surrey.
- SALISBURY**
Salisbury and District Short-wave Club (G2FIX/P).—C. A. Harley, 85, Fisherton Street, Salisbury, Wilts.
- SOUTH SHIELDS**
South Shields Amateur Radio Club*.—W. Dennell, G3ATA, 12, South Frederick Street, South Shields, Durham.
- SOUTHAMPTON**
Southampton Radio Club.—J. H. Sillence, 80, The Drive, Coxford, Southampton, Hants.
- SOUTHEND**
Southend and District Radio Society* (G5QK/P).—J. H. Barrance, 49, Swanage Road, Southend-on-Sea, Essex.
- SOUTHPORT**
Southport Amateur Transmitters' Association.—J. W. Nuttall, 75, Longacre, Southport, Lancs.
- STOKE-ON-TRENT**
Stoke-on-Trent Amateur Radio Society.—D. Poole, G3AW, 13, Oldfield Avenue, Norton-le-Moors, Stoke-on-Trent, Staffs.
- STOURBRIDGE**
Stourbridge and District Amateur Radio Society*.—W. A. Higgins, G5GF, 35, John Street, Brierley Hill, Staffs.
- STROUD**
Stroud and District Amateur Radio Club*.—K. D. Ayers, G2FRG, 1, Victoria Villas, Whiteshill, Stroud, Glos.
- SWINDON**
Swindon and District Short-Wave Society.—P. Greenwood, G2BUJ, 49, Western Street, Swindon, Wilts.
- TORQUAY**
Torbay Amateur Radio Society*.—K. J. Grimes, G3AVF, 3, Clarendon Park, Tor Vale, Torquay, Devon.
- WARRINGTON**
Warrington Radio Society (G3CKR).—J. F. Thomas, G3AWC, 510, Stockport Road, Thelwall, Nr. Warrington, Lancs.
- WELLINGTON**
Wrekin and Y.M.C.A. Radio Society.—T. W. Pollard, 12, Rose Grove, Wellington, Salop.
- WEST BROMWICH**
West Bromwich and District Radio Society*.—R. G. Cousins, 38, Collins Road, Wednesbury, Staffs.
- WOLVERHAMPTON**
Wolverhampton Amateur Radio Society*.—H. Porter, G2YM, 221, Park Lane, Fallings Park, Wolverhampton, Staffs.
- WORCESTER**
Worcester and District Amateur Radio Club.—J. Morris-Casey, G8JC, Brookhill Farm, Ladywood, Droitwich, Worcester.
- WORTHING**
Worthing and District Group, R.S.G.B.*—G. W. Morton, 42, Southfarm Road, Worthing, Sussex.
- YEOVIL**
Yeovil Amateur Radio Club* (G3CMH).—K. R. Gilbert, 48, Chilton Grove, Mudford Road, Yeovil, Som.
- YORK**
York and District Short-Wave Club.—G. W. Kelley, G5KC, 123, Kingsway West, Acomb, York.

* Affiliated to the R.S.G.B.
 † Membership restricted to Admiralty staff.
 § Membership restricted to transmitters.

LETTERS TO THE EDITOR

More Confusing Jargon • Reflectors for Improving Reproduction • Under-chassis Components • Magnetic Recording Standards

Inapt Nomenclature

MAY I comment on the use by certain workers of the term "grounded-grid" in place of "earthed grid"? This use is anomalous, in that not even the "grounded-grid" exponents themselves appear to advocate the general substitution of the American term "ground" for the British "earth." Such a proposal, being consistent, would at least be entitled to consideration. But substituting an American term in one particular connection only is not only objectionable on account of its irregularity, but it naturally conveys the impression (which I am assured is quite contrary to the intention of those who do it) that the earthed-grid was an American invention.

The only argument I have encountered in favour of the practice is that "grounded-grid" is more euphonious than "earthed-grid." If everyone who did not care for the sound of two standard terms in conjunction altered one of them in that conjunction only, technical literature would soon become more confusing than it is.

If it were a question of this one particular expression, a protest might not justify space in your journal. But it exemplifies a principle which, I suggest, deserves emphasis, namely, that our terminology should be as consistent, regular and logical as it is possible to make it, and that arbitrary and whimsical departures should be discouraged.

May I add that the term "mixer," as commonly applied to a crystal or diode detector of a superheterodyne is hardly apt? The incoming signal and local oscillation are mixed or added together elsewhere, and the mixture is then rectified in order to produce that more intimate combination which is necessary to yield a component of the desired new frequency. Two ingredients which do not react chemically can be mixed, but yield no new sub-

stance. The rectifier is analogous to a device for effecting chemical combination, resulting in products not present in the mixture. M. G. SCROGGIE.

Bromley, Kent.

Symbol of Inconstancy?

CAN any of your readers explain why

this



or this



is usually taken as a symbol of variability, while

this



is intended, I gather, to symbolize constancy?

The third symbol is probably older than the others, judging by dated arboreal and other carvings, so ought not the B.S.I. to fall into line and adopt the arrow-pierced symbol also to indicate constancy? It would be interesting to have the views of Mr. Bainbridge-Bell on the subject.

On second thoughts, the difference may not turn out to be so profound as it seemed, and the implied constancy may, in practice, be anything but. *La donna é mobile*, for example.

Southsea. D. K. McCLEERY.

Artificial Acoustic Reflectors

I WAS surprised that Mr. R. Marker's letter in your January issue, concerning the necessity and niceness of the higher audio frequencies, did not arouse comment, as, in my opinion, the placing of large reflecting surfaces in front of a loudspeaker is one of the keys to realistic orchestral reproduction in the home.

(Continued on page 112)

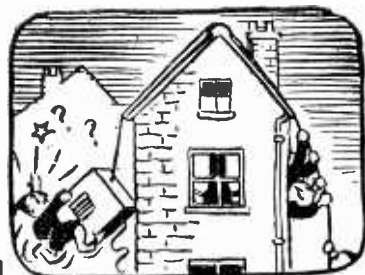

THE "FLUXITE QUINS" AT WORK

"Heave-ho on that aerial, son;
We'll FLUXITE this joint then we're done.
Something's wrong I declare,
't's got caught up somewhere,
The darn thing weighs nigh on a ton!"

See that FLUXITE is always by you—in the house—garage—workshop—wherever speedy soldering is needed. Used for over 40 years in Government works and by leading engineers and manufacturers. Of all Iron-mongers—in tins, 10d., 1/6 & 3/-.

TO CYCLISTS! Your wheels will NOT keep round and true unless the spokes are tied with fine wire at the crossings AND SOLDERED. This makes a much stronger wheel. It's simple—with FLUXITE—but IMPORTANT.

The FLUXITE GUN puts FLUXITE where you want it by a simple pressure. Price 1/6, or filled, 2/6.



ALL MECHANICS WILL HAVE

FLUXITE

IT SIMPLIFIES ALL SOLDERING

Write for Book on the ART OF "SOFT" SOLDERING and for Leaflets on CASE-HARDENING STEEL and TEMPERING TOOLS with FLUXITE. Price 1d. each.

FLUXITE LTD.

(Dept. W.W.), Bermondsey Street, S.E.1

Letters to the Editor—

Some recent experiments with a portable labyrinth loudspeaker, which radiates forwards only, have shown that one wall of a living room can be used most effectively as a reflector provided the surface is well broken up with pictures and furniture so as to diffuse the high frequencies, and a wide angle diffuser is used on the loudspeaker.

Ideally, of course, the wall should be curved to parabolic shape with the loudspeaker placed at the focus, in order to produce a plane wavefront. In practice, a horizontal strip of corrugated asbestos roofing, about two feet high and placed at ear level, in the form of a decorative frieze, might be used.

For solo artists and instruments, where some localization of sound source is required, the high-frequency deflectors on the loudspeaker should be removed.

Listening tests at the curtained, windowed end of a room definitely give the impression of being situated at the back of a concert hall, the apparent distance of the orchestra seeming to depend more on the amount of reverberation in the signal or record, and less on the actual volume level. Record scratch seems quite separated from the music. The tests were, of course, carried out from a position *behind* the loudspeaker.

Besides the remarkable increase in "presence," there is also a great apparent improvement in transient response and in clarity of instrumentation.

Now that various types of labyrinth loudspeakers are appearing on the market, it would be most interesting to hear from readers who are able to make tests similar to those described.

DESMOND ROE.

Old Hill, Staffs.

Components for Amateurs

WE were interested in S. Johnson's letter in your February issue regarding paper smoothing condensers for inverted mounting with the terminals through the chassis. So far we have experienced no demand from the constructor market, which has a considerable interest for us, for this construction. In fact, the bulk of our production,

including that for manufacturers, is for the conventional pattern with the fixing flanges and terminals at opposite ends. However, the inverted mounting arrangement can be supplied on the majority of our paper condensers and all that Mr. Johnson and his fellow amateurs need do is to add the letters "I.M." as a suffix after the type number when ordering. Prices are identical.

W. F. TAYLOR,

The Telegraph Condenser Company, Limited.

London, W.3.

Magnetic Recording

DURING May of last year the B.B.C. convened a meeting of radio manufacturers in order to agree on a set of standards to be adopted in the manufacture of magnetic tape recording equipment in this country.

It was proposed that the tape width should be 0.245 in instead of 0.254 in or 1 cm already adopted in Germany. Apparently no advantage was claimed for this, it was in fact agreed that the change would make no significant difference.

I am at a loss to know why this apparently non-standard "standard" was so unanimously adopted by all present, for it will mean that if machines made in this country have tape guides of reasonable tolerance they will be just unable to employ German tape. Can any reader supply the answer to this apparent anomaly?

LEONARD G. WOOLLETT.

Petts Wood, Kent.

Degrees for Ex-Servicemen

WITH regard to degrees for ex-Servicemen and those employed in the engineering industry during the war, some further information is to hand since last I wrote to you.

I have once more been in contact with the Ministry of Education who are discussing with the London County Council and the local education authorities in Essex, Herts, Middlesex, Surrey, Kent and Bucks, together with the technical college authorities, the question of the introduction of Saturday instruction, possibly in lieu of some evening work. The difficulty here is lack of staff

and the natural desire of the teaching staff to have a five-day week.

If suitable arrangements are to be made to assist the employees of the engineering industry, the object can only be fully achieved if qualified persons who are engaged in industry are prepared to assist the technical colleges by teaching on Saturday mornings in order to avoid some of the staff difficulties. It is hoped, therefore, that senior engineers will see the importance of training the younger members of the industry, both in physics and engineering, and that they will offer their services to the technical colleges throughout the country and particularly in the counties mentioned above and in the London area. This action will help to retain and increase the prestige and industrial efficiency of the nation.

O. S. PUCKLE,

Hedgeside, Holtspur End South, Beaconsfield, Bucks.

F.M. and Monopoly

IF Mr. Kinman (your February issue) does not know what I mean by the term "selfish minority," I will tell him. It means those people who buy, have installed, and make use of, electrical apparatus likely, when either new or old, to set up radio interference without troubling themselves about the annoyance they cause to listeners or taking any steps to reduce it. Is that plain enough? If reception in this country is, as Mr. Kinman seems to suggest in the third paragraph of his letter, as good as reception in other countries, why should we change to F.M.? The cost of fitting suppressors to the sources of interference is trifling compared with the cost of making broadcast reception devices proof against it. If Mr. Kinman likes figures, he can consider this: it is reasonable to assume that for every piece of interfering apparatus in the country (and that, I would emphasize, does *not* mean every conceivable piece of electrical equipment in existence; interference can nearly always be traced to a single offender out of scores of owners of electrical apparatus in a locality) a hundred listeners are affected. The cost of suppressing the interfering ap-

paratus may be set at an average £1. The cost to each of the suffering listeners, of buying a new F.M. receiver and having the essential 100-Mc/s aerial installed, is bound to be of the order of £20. The cost ratio thus works out at about 1 to 2,000. If Mr. Kinman feels that the cost of suppression (only enforced if there were complaints from listeners) is too heavy a burden for the country to carry in its present impoverished state, then I suggest that not only suppression but also the vastly more costly change to F.M. be dropped until times are better. We have put up with radio interference so long from the selfish minority that we can probably stand it a while longer.

Mr. Barrell (same issue) can take the foregoing as a reply also to his remarks about interference. Concerning the lay public's alleged wish for high-fidelity reproduction, I have the notion that if a demand of that nature had been genuine enough for the listening public to agree to pay for it, it would have been met long ago by the manufacturers without recourse to F.M. What people aren't prepared to pay for, they don't really want. I am surprised to hear that the incorporation of F.M. in an all-wave receiver would be easy and cheap—at a 100-Mc/s F.M. frequency.

W. H. CAZALY.

London, N.W.

Tonal Balance

THE article in your November issue on "High Audio Frequencies" quotes frequency ranges of 150-4,000 c/s, 70-7,000 c/s and 40-10,000 c/s as being those used in the American listening tests described. It has been stated on good authority that, in order to give an impression of well-balanced frequency response, a reproducing apparatus should respond to an equal number of octaves above and below 800 c/s, so that tone controls should restrict or augment both ends of the frequency range equally. It is interesting to note that the geometric mean frequencies for the "narrow," "medium," and "wide" ranges used in the American tests were approximately 775 c/s, 700 c/s and 632 c/s respectively; these are not the same, although the

differences are not great, and the mean frequency of the "wide" range is the farthest from 800 c/s. It would appear possible that the effects of high frequencies in "wide range" reproduction may have been observed to some extent by a slight preponderance of low frequencies.

The same objection would apply, with greater force, to the acoustic test carried out by H. F. Olson; in this case the filter is described as having cut off all frequencies above 5,000 c/s without, apparently, affecting low frequencies. R. T. L. ALLEN.

Bristol.

Radiated Interference

I THINK it is high time that the attention of radio manufacturers be drawn to the use of the I.F. of 465 kc/s in broadcast receivers. In this northern area the strongest B.B.C. Home Service station is North Regional, 668 kc/s, and when people with the cheaper makes of superhet receivers (without an R.F. stage) are receiving the B.B.C. Light Programme on 200 kc/s there is a very strong heterodyne whistle of 1 kc/s to 3 kc/s on the Home Service of 668 kc/s. I come across this trouble at least once a week.

According to the manufacturers' rules if the set is still under guarantee the I.F. cannot be changed to offset this trouble until the guarantee has expired. On the other hand, Condition 3 of the broadcast receiving licence imposes an obligation to avoid the radiation of interference.

Re-radiation of an average receiver can cause this interference from its oscillator up to 250 yards and in closely populated areas this can affect at least 20 sets.

R. A. COLLINS.

Grimsby, Lincs.

MECHANICAL HANDLING

HOW the mechanized handling of goods can save labour and speed production, storage and transport in industry will be demonstrated at the first National Mechanical Handling Exhibition which will be held at Olympia from July 12th to 21st. It is being organized by *Mechanical Handling*, one of our associated journals.

Dependability

Plus

TRIX Quality

**GRAMO-RADIO
AMPLIFIERS**

Several models are available incorporating 30 watt or 15 watt Amplifier combined with gramophone player or automatic record changer and radio receiver with monitor speaker. A.C./D.C. models also available.

Write for illustrated list of full Sound Equipment Range for every type of installation.
Model R.G.A. 633B/RC.



TRIX

Quality

SOUND EQUIPMENT

THE TRIX ELECTRICAL CO. LTD.
 1-3 MARLE PLACE-TOTTENHAM COURT ROAD-LONDON, W-1
 TELEPHONE: MUSGRAVE 5817. SOARLYS CROSS, TRIXRADIO, WESLO, LONDON.

Unbiased

By FREE GRID

Descent from Olympus

"Anni Profluent Fugaces,
Mores Corruent Sequaces."

SO sang the poet; but it is evident that the Editor does not agree with him but is obsessed by that fear of change which perplexes monarchs, as Milton tells us in "Paradise Lost." Since Editors, like captains of ships, are virtually monarchs this is not altogether surprising but all the same I am rather taken aback by his complete indifference to the change in literary style which has been forced on us by the paper shortage. The rolling periods of his *ex cathedra* utterances each month are far too reminiscent of Macaulay in his lushest lucubrations. They are more suited to the spacious age when papers were used freely by ladies for nocturnal curlers than to these difficult times when we are hard put to it to find enough for our more basic needs, and, in view of a further threatened act, are going to find it still harder.

I may say that for some time past I have been urging upon the



Used freely by ladies.

Editor the necessity of a change in this direction by making one word do the work of two instead of two doing the work of one as at present. He suggested the use of shorthand. I tactfully pointed out, however, that whilst I admired his modesty in implying that his pontifical thunderings were read only by stenographers, I was of the opinion that he had a far wider circle of readers, most of whom were quite unfamiliar with shorthand. His proposal would, therefore, create a big demand for manuals of shorthand instruction. This would result in the use of far more paper

than would be saved, rather in the manner of the modern Erewhon where such a huge army of employees was occupied in the paper-saving propaganda department that more paper was used in printing the necessary currency to pay their salaries and wages than they persuaded people to save.

The use of Basic English seemed an obvious solution but to my mind the cold and unfeeling bare bones of which it is composed are an altogether unfitting medium for expressing the Editor's opinions which I have always found to be full of warmth and colour, even if at times they irritate me almost beyond endurance.

No, the only idiom which, in my opinion, meets the case, is the staccato one used by Mr. Pickwick's erstwhile friend Mr. Jingle. Not only does it express opinions and narrate facts with the utmost economy of words but does so in an effective and colourful manner worthy of the Editor at his best. Postmaster-General — takes money — no value given — idiotic regulations — drastic action — organize strike — all switch off — B.B.C. bankrupt — no mourners — commercial broadcasting — hopeless chaos — B.B.C. resuscitated — regulations amended — everybody happy.

But perhaps after all telegraphese would be the ideal for a journal which, from its earliest days, has been the *vade-mecum* of the telecommunications fraternity.

Morton's Fork

I HAVE always been a very staunch upholder of law and order especially in those instances where the particular law in question has my moral approval. I have, however, recently had such a flagrant break of the wireless licence laws forced on my attention that I cannot help bringing it to the light of day. I do so in spite of the fact that it contravenes to some extent the unwritten laws of hospitality which we all, whether host or guest, endeavour to observe.

I feel, in fact, rather like Henry VII on the occasion of his week-end visit to the Earl of Oxford soon after he had attempted to grapple with the manpower problem by making it an offence to keep retainers without a permit from the

Ministry of Labour. Those of you who availed yourselves of the opportunities with which your parents provided you of acquiring historical learning instead of indulging in surreptitious games of noughts and crosses, will recollect the occasion. He was being shown to his carriage through long lines of men of martial bearing, and was astonished to learn on enquiry that they were not domestic servants but retainers. He at once replied "I thank you for your hospitality, My Lord, but I cannot afford to have my laws broken in my sight." Any of the modern representatives of the de Vere family will give you further details if you require them.



Into my confidence.

I find myself in a similar predicament to Henry VII inasmuch that having recently been a guest at one of our basically hit hotels, I feel myself in duty bound to follow Henry's example and bite the hand that fed me.

By taking one of the chambermaids into my confidence, I found out that a large number of my fellow guests had in use in their rooms one of the tiny personal receivers that are now being turned out by some manufacturers. Tactful enquiries among the guests revealed that none of them had brought his licence with him as demanded by a portion of No. 7 of the regulations printed on the backs of our licence forms, and they were, therefore, infringing the law. Had they brought their licences with them, of course, they would have fallen into the trap of regulation No. 6 which demands that their home set *and its licence* be open to inspection at reasonable hours.

The only way in which the law could be fully complied with would be by taking out a second licence at a cost of £1, and it was this Morton's Fork sort of extra money-getter which I presume the P.M.G. had in mind when he framed the regulation over twenty years ago. Now is the time for him to reap his long awaited harvest of extra licence fees; the fines are not, of course, his perquisites.

Short-wave Conditions

January in Retrospect : Forecast for March

By T. W. BENNINGTON (Engineering Division, B.B.C.)

DAYTIME maximum usable frequencies for these latitudes failed to show the expected tendency to increase towards the end of January, and consequently, over the month as a whole, they were considerably lower than had been expected.* This seems to indicate that the seasonal peak in daytime M.U.F.s—expected in February—may be a little late this year, but undoubtedly one will occur, either in late February or early March. In spite of their failure to reach the expected mean value, daytime M.U.F.s during January were yet relatively high, and radio conditions such as to favour the higher—though not the highest—frequencies suitable for long-distance communication. As far as is known the 50-Mc/s amateur band, for example, was never suitable for this purpose. Night-time working frequencies were also relatively low, though not low enough to render really necessary the use of frequencies lower than about 9 Mc/s, except over a few high-latitude paths.

Though there were some ionosphere storms during the month, none of these was of very great intensity, and the month might be considered as being relatively quiet. The periods of most disturbances were 2nd/3rd, 6th/9th, 12th/13th, 17th/18th, 21st/23rd and 29th/31st.

Forecast.—It is expected that during March there will be a slight decrease in the daytime M.U.F.s for these latitudes, and a considerable increase in those for night-time. The combined effect of the seasonal and sunspot cycle changes would appear to be such as to produce this result.

Daytime working frequencies for nearly all circuits should, therefore, remain quite high, and long-distance communication on exceptionally high frequencies should be frequently possible in all directions. Daytime frequencies will remain operative for considerably longer periods than during February, due to the lengthening hours of daylight in the Northern Hemisphere. The 28-Mc/s amateur band should be regularly usable for long periods. Frequencies as high as 15 Mc/s—or even higher on some circuits—should remain usable till well after midnight, and only on high-latitude transmission paths is it likely that

frequencies lower than 11 Mc/s will be really necessary at any time during the night.

For transmission over distances between about 600 and 1,000 miles the E layer may sometimes control transmission during the daytime, rendering higher frequencies usable than would otherwise have been so. Sporadic E ionisation is not likely to be much in evidence.

Below are given, in terms of the broadcast bands, the working frequencies which should be regularly usable during March for four long-distance circuits running in different directions from this country. (In these reports all times are in G.M.T.) In addition a figure in brackets is given for the use of those whose primary interest is the exploitation of certain frequency bands, and this indicates the highest frequency likely to be usable for about 25 per cent of the time during the month for communication by way of the regular layers:—

| | | | |
|-------------------|------|-----------------|-----------|
| Montreal : | 0000 | 11 Mc/s | (17 Mc/s) |
| | 0400 | 9 " | (14 ") |
| | 0900 | 11 " | (18 ") |
| | 1000 | 17 " | (25 ") |
| | 1100 | 21 " | (32 ") |
| | 1300 | 26 " | (37 ") |
| | 2000 | 21 " or 17 Mc/s | (33 ") |
| | 2200 | 15 " | (22 ") |

| | | | |
|-----------------------|------|---------|-----------|
| Buenos Aires : | 0000 | 17 Mc/s | (23 Mc/s) |
| | 0100 | 15 " | (21 ") |
| | 0700 | 17 " | (24 ") |
| | 0800 | 21 " | (31 ") |
| | 0900 | 26 " | (42 ") |
| | 2000 | 21 " | (29 ") |
| | 2200 | 17 " | (23 ") |

| | | | |
|--------------------|------|---------|-----------|
| Cape Town : | 0000 | 17 Mc/s | (23 Mc/s) |
| | 0200 | 15 " | (21 ") |
| | 0500 | 17 " | (24 ") |
| | 0600 | 21 " | (28 ") |
| | 0700 | 26 " | (42 ") |
| | 1900 | 21 " | (29 ") |
| | 2100 | 17 " | (24 ") |

| | | | |
|--------------------|------|---------|-----------|
| Chungking : | 0000 | 11 Mc/s | (16 Mc/s) |
| | 0400 | 15 " | (22 ") |
| | 0500 | 17 " | (27 ") |
| | 0600 | 21 " | (32 ") |
| | 0700 | 26 " | (36 ") |
| | 1400 | 21 " | (28 ") |
| | 1500 | 17 " | (24 ") |
| | 1800 | 15 " | (20 ") |
| | 1900 | 11 " | (18 ") |

A considerable amount of ionosphere storminess often occurs during March, and it is not anticipated that the month will pass without some serious—perhaps severe—disturbances occurring. At the time of writing it would seem that disturbances are more likely to occur during the periods 1st/3rd, 12th/13th, 16th/17th, 23rd/25th and 28th/30th than on the other days of the month.

Don't pay FANCY PRICES for cases



We have reduced the design and assembly of instrument cases to a fine art. The special processes we have developed enable us to offer you cases of the highest quality at prices which save you money and, when necessary, within 7 days from receipt of order.

IMPOSSIBLE? BUT IT'S TRUE
TRY US AND SEE



PRECISION BUILT
INSTRUMENT CASES

ALFRED IMHOF LIMITED.
112-116, NEW OXFORD ST.,
LONDON, W.C.1. MUSEum 5944

* They were, in fact, slightly lower than during January, 1947, due, no doubt, to the recent decrease in sunspot activity.

RANDOM RADIATIONS

By "DIALLIST"

B.S. 1409: 1947

IT'S clear that a great deal of thought has gone into the compilation of this new British Standard, concerned with letter symbols for electronic valves. The basic idea is first-rate: capitals for everything outside the bulb and small letters for everything within it. But it is not always easy to draw completely hard-and-fast distinctions. Instability, for instance, due to unwanted positive feedback effects may be due more to stray capacitances in the valve-cap, the valve-holder and the wiring than to that between the grid and the anode inside the bottle. We used to lump them all as C_{ag} ; now the actual anode-grid capacitance becomes c_{ag} and I suppose we ought to refer to the total effective capacitance of that kind in a circuit as $C_{ag} + c_{ag}$. I'm not quite convinced that the new method of denoting grids (or electrodes made in the form of grids) is altogether an improvement. When, for example, you saw g_{scr} or g_{sup} in the text, you knew at once that the screen or suppressor grids were concerned; now g_2 , g_3 and so on can stand for a variety of grids with different functions. In the heptode used as a frequency changer is the oscillator anode to be designated g_2 ? Or are we entitled to regard the oscillator portion as a triode and to write a_1 ? Whilst I'm being critical (please don't think that I am unappreciative) I must say I think that the new Standard rather overworks the subscripts, particularly the multiple subscripts, you can, as an example, write the peak voltage on the second anode of the diode portion of a double-diode as $V_{(pk)a_2}$; but I'm not sure that your reader is going to bless you if you do. To be effective any form of shorthand should be not only easy and quick to write, but also easy and quick to read. The worst of subscripts is that they necessitate the use of very small type, which tries the tired eyes of the student in the course of long, close reading.

□ □ □

Anti-interference

TWO praiseworthy efforts to reduce interference with wireless and television reception have been made recently. The first is the edict by whatever body is now responsible for London's buses that all those of non-diesel type are to be fitted forthwith with suppressors in their

ignition systems. The diesels, of course, don't need them since they don't have electric ignition. The second is a campaign by the organization to which the majority of the concerns which sell radio and television sets to the public belong to get its members to fit suppressors to all their delivery and service vans. It is stated that interference can be reduced to negligible proportions by merely fitting a 5 or 10-k Ω resistor in series with the main distributor lead. As the cost of doing that, even if "labour charges" are involved, can't much exceed a shilling or so a vehicle, the response from people so vitally interested in the suppression of interference should be one hundred per cent.

A Golden Opportunity

Every recent report on interference, including the B.B.C.'s field trials on 45 and 90Mc/s, has stressed the fact that by far the most serious form of interference with A.M. and F.M. sound broadcasts and with television transmissions comes from the ignition system of i/c vehicles. At the present time the number of these, whether for private or commercial use, that can be sold by the motor manufacturers in this country is quite small. The distribution of available vehicles and the conditions under which they are sold are under the strictest Government control. Then why not make a cast-iron regulation that no new unsuppressed vehicle may be sold or bought? Why not, again, make it a condition of the grant of an emergency petrol ration that no motor vehicle shall qualify for it unless its ignition system has been "suppressed"? It all seems too easy. Perhaps that's why it probably won't be done.

□ □ □

Queer Business

ONE of the linguistic curiosities of today is the extraordinary barrenness of French in electrical and radio technical terms. It's all the more difficult to understand because the French have played a big part in both the laboratory and the engineering development of most branches of electricity. Ampere was a pioneer worker and the Eiffel Tower was perhaps the best-known wireless station in the world in the early days. Unlike German and many other tongues, French does not readily coin or accept new

native words to denote new things as they come along; it seems rather to prefer borrowing terms from other languages (very often English, or the variety of our language used in America), with not always very happy results. Sometimes these words are transliterated to give them a French appearance and they may then come to take on meanings rather different from those they had originally. Recently it has fallen to my lot to look over the proofs of French translations of two or three English technical books and this, more than anything else, has made me realize that, though for most other purposes it is one of the world's richest and most flexible languages, it is not at the moment a first-rate medium for conveying the technicalities of our particular branch of science. There seems to be a genuine need for a committee of the Academie Française to draw up and standardize a technical vocabulary to meet the requirements of today.

□ □ □

Table Model Televisors

IT is predicted in America by those who should know what they are talking about that in the near future table model televisors (they call them televisers) will be far more popular than consoles. I'd be rather inclined to agree that the same thing may happen here unless designers can be brought to realize the importance of placing the viewing screen at about the normal eye-level of the viewer as he sits and watches it. I have just been making some measurements and find that my eyes are from about 36 to 48 inches above the floor, according to the kind of chair I'm sitting in and the way I sit in it. In many consoles the centre of the screen is much below eye level unless you pretty well lie down to your viewing. So long as only two or three people, who can all sit in one row, are looking in all goes well, for they can adjust their sitting height to suit the instrument. But when the audience is larger it is a case of two rows or more, and those at the back are bound to find the images somewhat distorted. With a table model, on the other hand, and a few family albums, atlases and other tomes culled from the bookshelves, you can so adjust things that:

$$h = m.e.l.,$$

where (as the textbooks have it) h = height of centre of viewing screen above floor; and $m.e.l.$ = mean eye level of audience. This is a lot easier than endeavouring (as you must with a console) to adjust the audience so that:

$$m.e.l. = h.$$

For Battery Users

ONE thing that the user of a battery radio receiver has never been given is a device which will call his attention to the fact that his set is switched on; or at all events something which will prevent him from leaving his precious batteries at work when he retires to bed. It exasperates him to find that he has run down his filament accumulator to no purpose; it is still more annoying to reflect that the expensive and rather short-lived H.T.B. has been dealt a blow from which it can never fully recover. It is so easily done with the commonly seen continuously rotatable wave-change switch which incorporates an on-off section. He's been listening to the home programme on the medium waves. Instead of moving the switch one "click" clockwise to close down, he carelessly turns it anti-clockwise to the L.W. position. As the local stations comes in so strongly that the volume control is turned well down, nothing is heard in the long-wave position. It doesn't vastly matter if you do this kind of thing with a mains set; but you're not likely to, for the warning gleam of a pilot light hits you in the eye. It is only the far more vulnerable battery set that has no such safeguard. You can't very well have 2-volt pilot lamps run from the accumulator of a battery set, for even those most economical of current would consume as much as an additional pair of valves. What then is the answer? Two possible lines of attack on the problem occur to me and I present them free of charge to any designer who wants a strong selling point for his this year's battery model. The first is the minute neon lamp, not much bigger than a large pea, which we used as an indicator on the switchboards of some radar sets during the war. One of these placed behind a window in the front of the set and connected across the H.T.B. by the on-off switch might do the trick. The current consumption must be minute. The radar types were for 230 V, but I believe tiny neons are, or could be, made for operation from the ordinary H.T.B. Failing these, what about a simple time switch opening automatically, say, two hours after being closed? Few people would mind having to switch on again in the middle of a programme if they knew that this arrangement completely safeguarded them from the chance of wrecking their H.T.B.s. I'd make this switch quite separate from that doing the wave-changing, and its action would be mechanical, so that it would put no drain on to either battery. Can anyone think of better ways of solving the problem?

Mains-Dropping Resistors

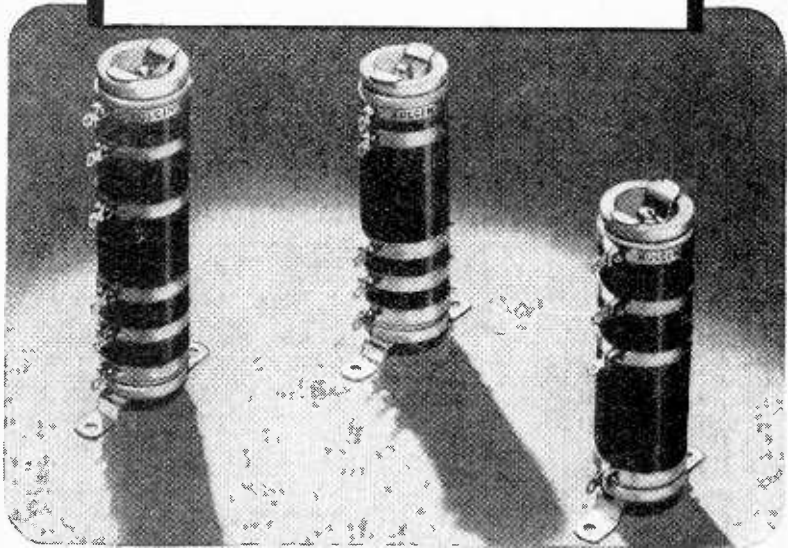

for every A.C./D.C. job

BULGIN, high-grade dropping resistors are in continuous demand for universal receivers operated from a.c. or d.c. mains. Their use ensures correct operation of the valve-heaters, giving long life and efficient performance. Being tapped for all usual mains voltages, instant adjustment can be made for supplies at different pressures.

Solenoidally, single-layer wound on heat-resisting formers with finest, non-corrodible, oxide-insulated resistance wire of "constant- Ω " characteristics, thereby avoiding the change, upon heating up, of resistance value. With clearly marked tapping bands, for lashed-and-soldered connections. Accuracy of resistance, $\pm 10\%$, overall and per section. Max. overall dimensions 2in. x 5in. high. Fixing centres, 1 $\frac{1}{2}$ in. approx.; 2 x 6 BA. holes.

See our display on Stand No. 24 R.C.M.F. Exhibition, Great Hall, Grosvenor House, W.1. March 2-4.

"The Choice

BULGIN

REGISTERED TRADE MARK

of Critics"

A. F. BULGIN & CO. LTD. · BYE-PASS RD. · BARKING

Telephone: RIP. 3474 (5 lines).

RECENT INVENTIONS

A Selection of the More Interesting Radio Developments

RADAR

THE interval between successive exploring pulses is usually made greater than the time required for the echo signal to return from the most distant target. It, however, the echo signal is arranged to trigger the transmitter, then the repetition frequency gives a direct indication of the distance of the target under observation, and will convey this information to any outlying gun emplacement or other remote station that is equipped with a suitable receiver.

When several targets come under simultaneous observation, this scheme obviously becomes unworkable. According to the invention, the difficulty is met by selecting one particular target, by means of a variable-delay device which is fed with "marker" impulses from the transmitter. The adjustment required to align the marker with the selected echo image on the time base of the C.R. indicator automatically regulates the triggering of the transmitter until the pulsing frequency directly indicates the distance of the selected target.

Standard Telephones & Cables, Ltd. (assignees of L. A. de Rosa). Convention date (U.S.A.) February 20th, 1943. No. 579863.

provides a sufficiently wide gap between the resonant circuits to prevent shock-excitation. A number of fixed I.F. amplifiers can also be incorporated, in order to increase the stability and selectivity of the receiver.

Marconi's Wireless Telegraph Co., Ltd. (assignees of W. R. Koch). Convention date (U.S.A.) September 8th, 1943. No. 586534.

MULTI-STAGE VALVES

SUCCESSIVE electrodes in the same valve are arranged to operate as two separate stages, in cascade, the heat generated by the impact of the primary electron stream on the anode CA of the lower stage being used to liberate a fresh supply of electrons for the upper stage. The "cathode" CA and the upper anode A are separately biased, in order to apply sufficient acceleration to the primary stream to ensure secondary emission, and to maintain the required potential gradient between the two stages. Apart from the saving of power and the elimination of anode cooling devices, the close spacing of the electrode system is stated to be advantageous for short-wave working.

In the modulator circuit shown, the lower stage of the valve acts as an

along the nodal line. The whole unit is preferably enclosed in an evacuated glass bulb. No appreciable damping can occur, because all the crystal supports and connections are located at points where mechanical vibration is at a minimum.

The British Thomson-Houston Co.,

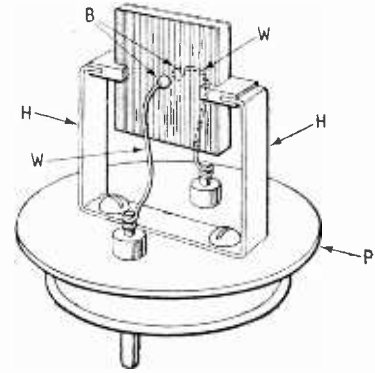

Piezo crystal mounting.

Ltd. (communicated by the General Electric Co.). Application date, October 27th, 1944. No. 584072.

RADAR SYSTEM

A SINGLE tube of the klystron type is used to generate (a) exploring pulses on a centimetre wave, and (b) local oscillations, which are mixed with the echo signal in order to produce a beat frequency that can readily be amplified.

It is shown that a klystron can be made to oscillate at two distinct but closely related frequencies, say f_1 and f_2 , if the anode voltage is changed from one specific value to another. In one mode of operation, the applied voltage is such that the time of transit of the electrons across the drift space causes the two resonators to oscillate in phase, whilst in the second case they oscillate in phase-opposition. For instance, an exciting pulse of 10,000 volts is applied to the anode during the relatively short periods of transmission to generate the frequency f_1 . The pressure then falls to 6,000 volts during the longer period of reception, when local oscillations at a frequency f_2 are produced.

The advantage of the arrangement is that any factor tending to vary the frequency f_1 will similarly vary the frequency f_2 , so that the essential beat frequency remains constant.

J. Sayers, M. L. E. Oliphant and C. S. Wright. Application date March 5th, 1941. No. 585207.

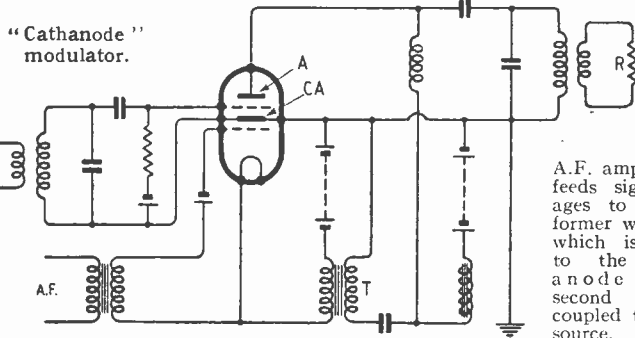

A.F. amplifier and feeds signal voltages to a transformer winding T, which is coupled to the upper anode A. The second grid is coupled to a R.F. source, and the amplified carrier wave is modulated on the anode A, before being fed to the load R.

Standard Telephones & Cables, Ltd. and A. J. Maddock. Application date May 22, 1942. No. 586149.

SUPER-REGENERATIVE RECEIVERS

THE use of tuned R.F. circuits, for the purpose of increasing selectivity, prior to the point of regeneration, is complicated by the liability of such circuits to be "shock excited" by the quenching frequency and by the large R.F. currents already existing in the regenerated circuits.

The problem is solved, according to the invention, by tuning the input of the super-regenerative valve to a frequency far removed from that of the signal, and by coupling it to the aerial through a superheterodyne comprising at least two frequency-changing stages. Both the latter are associated with a common local oscillator, one stage producing a "difference," and the other a "summation" beat frequency. This

PIEZO-ELECTRIC CRYSTALS

THE nodal line of a quartz oscillator is found by observing the pattern formed by a powder sprinkled on it when the crystal is vibrating at its fundamental frequency, and a slot is cut at each end of the line to take the insulated ends of a spring holder H, clamped to a baseplate P.

Each face of the crystal is coated with a metallic film electrode, and the circuit is completed by soldering the ends of two wires W to silver-paste blobs B, which have previously been deposited on each electrode at points

The British abstracts published here are prepared with the permission of the Controller of H.M. Stationery Office, from specifications obtainable at the Patent Office, 25, Southampton Buildings, London, W.C.2, price 1/- each.

DELIVERIES IMPROVING

ON ALL



INSTRUMENTS



The "AVO" TEST BRIDGE

A self-contained 50-cycles Bridge of exceptional accuracy for direct measurement of all normal values of condensers and resistances. Except at extreme ends of scale, accuracy is within 5%.

Facilities also provided for condenser power factor measurements and leakage tests by the flashing neon method; resistance, capacity and large inductance measurements against external standards. May also be used as a valve voltmeter indicator for measurement of audio and radio frequency voltages.

| CAPACITY | RESISTANCE |
|------------------|---------------------------|
| .000005-.005mFd. | 5-5,000 ohms |
| .0005-.5mFd. | 500-500,000 ohms |
| .05-50mFd. | 50,000 ohms to 50 megohms |

Size 7 $\frac{1}{2}$ " x 7" x 4 $\frac{1}{2}$ ". Nett Wgt. 4 lbs. 12 ozs.

OTHER "AVO" INSTRUMENTS

THE MODEL 7 UNIVERSAL AVOMETER
THE MODEL 40 UNIVERSAL AVOMETER
THE "AVO" SIGNAL GENERATOR
"AVO" VALVE CHARACTERISTIC METER

"AVO" ELECTRONIC TESTMETER
THE UNIVERSAL AVOMINOR
THE "AVO" LIGHT METER
ETC. ETC.



The "AVO" VALVE TESTER

Indicates mutual conductance direct in mA/V. Tests at makers' specified electrode voltages. Any valve base arrangement set up; easily operated multi-roller Universal Selector Switch. Tests Cathode-Heater insulation of an indirectly heated valve when the valve is hot; emission of diodes and rectifiers; indicates filament continuity and electrode "shorts." Coloured scale indicates valve as "Good," "Indifferent" or "Replace." No calculations of any kind involved. Works from A.C. mains. Complete with Universal valve panel fitted with multi-roller Universal Selector Switch enabling all English, American and Continental valves to be tested. Valve data book containing test details of nearly 2,000 English and American valves also supplied.

**These
MODELS
IN STOCK
for
IMMEDIATE
DELIVERY!**

We are steadily catching up on the ever-increasing demand for 'AVO' Instruments, and orders are being dealt with in strict rotation. We are pleased to announce, however, that we can now give delivery from stock of the three instruments here illustrated.



The D.C. AVOMINOR

A 2 $\frac{1}{2}$ -inch moving coil meter for making D.C. measurements of milliamps, volts and ohms. Total resistance is 100,000 ohms, and full scale deflection of 300 v. or 600 v. is obtained for a current consumption of 3 mA. or 6 mA. respectively. Supplied with pair of leads, interchangeable testing prods and crocodile clips, and instruction booklet.

Size 4 $\frac{1}{2}$ " x 3 $\frac{1}{2}$ " x 1 $\frac{1}{2}$ ". Wgt. 12 $\frac{1}{2}$ ozs.

| CURRENT | VOLTAGE | |
|---------------|-----------|------------|
| 0-3 milliamps | 0-6 Volts | 0-120Volts |
| 0-6 " | 0-12 " | 0-300 " |
| 0-30 " | 0-60 " | 0-600 " |
| 0-120 " | | |

| RESISTANCE | |
|---------------|----------------|
| 0-10,000 ohms | 0-600,000 ohms |
| 0-60,000 " | 0-3 megohms |

● Complete descriptive Booklet available on application to the Sole Proprietors and Manufacturers

THE AUTOMATIC COIL WINDER & ELECTRICAL EQUIPMENT CO., LTD.
WINDER HOUSE · DOUGLAS STREET · LONDON · S.W.1 · TELEPHONE · VICTORIA 3404/9

Stabilised Insulation BY MODERN IMPREGNATION METHODS

HYMEG

HIGH-SPEED PRODUCTION

Now, special methods of continuous conveyor impregnation and baking developed with the use of HYMEG have still further reduced processing times to a fraction of those previously believed necessary.

Often faster than infra-red baking with none of the defects, reduced handling, absence of special jigs, with complete freedom from blistering, bubbling and porosity, are some of the advantages claimed and substantiated for HYMEG High Speed Production methods.

HYMEG Synthetic Insulating Varnishes are recognised and widely used for their mechanical rigidity, improvement of electrical properties of windings; heat, moisture, oil, acid and alkali resistance as well as for the considerably reduced stoving time necessary.

HYMEGLAS

GLASS FIBRE INSULATION SYSTEM

This integrated system of development is successful in enabling machines to be designed and operated without weak links in the chain of insulation below 200°C. Thus the fullest advantage is taken of modern glass fibre insulation by providing a degree of bonding and insulation at every point in which the uniting of Hymeg impregnation with the Hymeg as used for subsidiary insulations gives a solid homogeneous winding of equally efficient characteristics and heat resistance throughout.

Hymeglas therefore virtually eliminates any risk of insulation failure and enables motors and the like to operate under abnormal conditions for long periods without risk of electrical breakdown.

Due to the excellent space factor of glass fibre as compared with the more usual asbestos and mica Class B insulations, it is often possible in redesigning with the Hymeglas system to employ larger copper sections with well-known advantages.

The Berger Technical Service—the research work of which produced "HYMEG" and "HYMEGLAS" is available to advise manufacturers on all problems of insulation. Get in touch now with—

LEWIS BERGER & SONS LTD. (Est. 1760)

35, BERKELEY SQUARE, LONDON. W.1.

Telephone: MAYfair 9171.

MANUFACTURERS OF HIGH-PERFORMANCE INSULATING VARNISHES AND ENAMELS



PRECISION COMPONENTS

CORD DRIVES

Now available in five types as illustrated (left to right) Standard, R/V, Reverse, "D" type and "A" type. All one hole fixing.

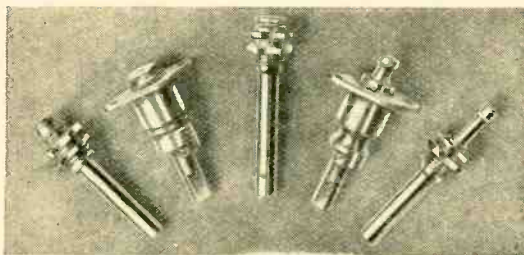

GANG CONDENSERS

A wide range is now available in 1, 2, 3 or 4 gang types of various capacities.

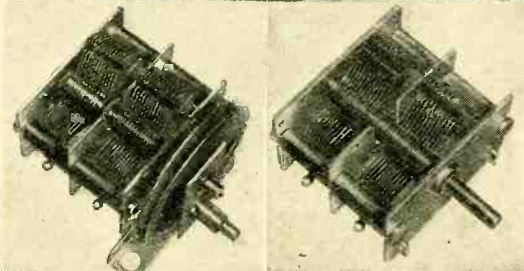

Write for Catalogue No. (W.W.I.)

JACKSON

BROS (LONDON) LIMITED

KINGSWAY · WADDON · SURREY

TELEPHONE: CROYDON 2754-5 TELEGRAMS: WALFILCO,
PHONE, LONDON



TECHNICAL TOPICS

for Amplifier designers

● The Question of Distortion

How much distortion can I allow? Much has been written about 'distortionless' reproduction, and considerable detailed design is necessary to produce good performance. Of the three kinds of distortion prevalent, namely, amplitude, frequency, and phase distortion, that of amplitude distortion is probably the most obvious, and frequency distortion in the form of 'tone controls' is often deliberately introduced. Amplitude distortion introduces frequencies not present at the input, giving a harsh colouration to the loudspeaker reproduction, which is largely the cause of popular objection to 'top' in response, and leads to so-called 'tone controls' which by reducing the top response, muffle the distortion. It is important that a good amplifier design can give its full output for all frequencies in the musical scale, avoidance of distortion introduced by valve overloading at the lowest bass frequencies being as important as a wide frequency response. Amplifier valves for use in different stages are given below.

| TYPE OF SET | 1st STAGE AMPLIFIER | 2nd STAGE AMPLIFIER | OUTPUT STAGE | Power Output Watts |
|----------------|--------------------------------|--|---|--|
| 2 Volt Battery | HL2 HL2 | — HL2 | KT2 2/KT2 push pull | 0.5 1.0 |
| DC/AC | L63 or KTZ63 | — | 2/KT33C push pull | 15.5 Max. |
| AC | KTZ63 KTZ63 KTZ63 L63 | — L63 2/L63 push pull 2/L63 push pull | KT61 2 KT61 push pull 2/PX4 " " 2/KT66 " " | 4.3 Approx. 11.5 " " 13.5 " " 17-50 " " |

Osram
PHOTO CELLS

S.E.C.
CATHODE RAY TUBES

Osram
VALVES

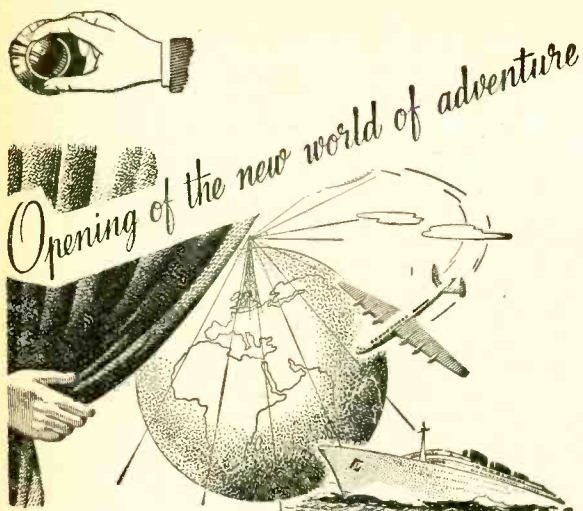

Pull back the curtain on the age of electronics—the era of industry that began with the end of the war. The development of new services on land, at sea and in the air is all part of the Marconi post-war plan. From the first great adventure of wireless communication more than half a century ago Marconi's have never looked back.

Today they are looking *forward*—to the reconstitution of old services and the introduction of new achievements in the world of wireless communications.

Marconi

THE GREATEST NAME IN WIRELESS

MARCONI'S WIRELESS TELEGRAPH COMPANY LIMITED
 THE MARCONI INTERNATIONAL MARINE COMMUNICATION COMPANY LTD
 MARCONI HOUSE · CHELMSFORD · ESSEX

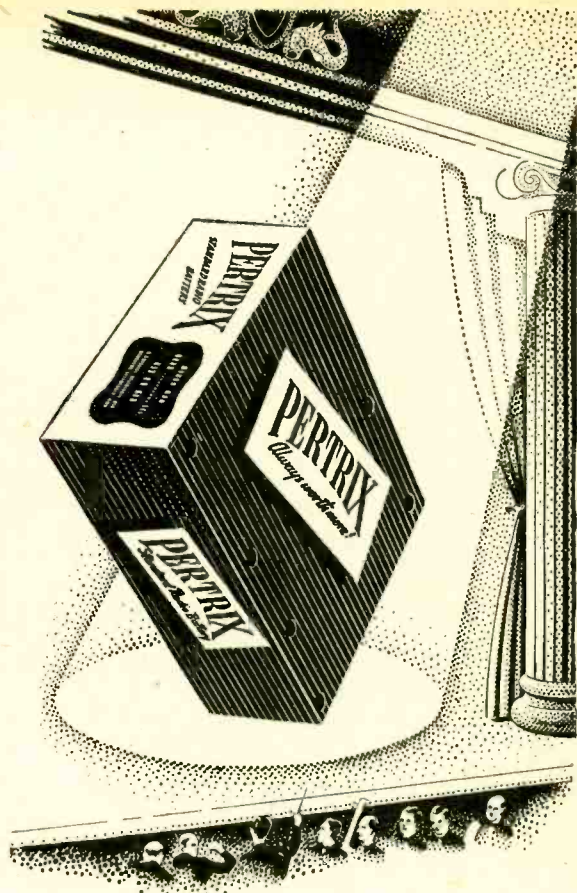

No 'Noises off'

PERTRIX RADIO BATTERIES, in the red and yellow pack, are now firmly established in the post-war market. One reason—a Pertrix battery supplies power and nothing else. No mush or crackle to interfere with good listening—the result of a battery doing its work quietly, efficiently and unobtrusively. What's more it goes on doing it for a long time. Stick to Pertrix.

HOLSUN BATTERIES LTD
 137 Victoria Street, London, S.W.1.



The Hadley Multicom

the Inter-Comm for which the public has been waiting, this marvel in miniature provides for complete communication between all points i.e. any one unit can communicate with any other unit at will.

The Hadley Intercommunicator

provides for two-way calling and communication between master unit and any or all of the sub-stations and also incorporates the novel feature of a desk radio which can be relayed to the sub-stations.



The Hadley Industrial Unit

proved to be well in advance of any similar equipment. Provides all facilities for "Staff Location" "Music for the Workers" "Time Signals," etc.

★ Firms with suitable sales, installation, and maintenance facilities, are invited to write for details of our agency scheme. Enquiries from overseas markets especially welcomed.

Hadley

SOUND EQUIPMENTS

BEARWOOD ROAD, SMETHWICK, STAFFS.

Phone : BEARwood 2575/6



Main Details of the Range of
CELESTION PERMANENT MAGNET LOUDSPEAKERS

| CHASSIS DIAMETER | MODEL | SPEECH COIL IMPEDANCE OHMS | POLE DIAMETER | FLUX DENSITY GAUSS | TOTAL GAP | PEAK HANDLING CAPACITY |
|------------------|-------|----------------------------|---------------|--------------------|-----------|------------------------|
| 2½" | P2V | 3.0 | 7/16" | 8,500 | 8,000 | ¼W |
| 3½" | P3C | 3.0 | ¾" | 7,700 | 24,000 | 1W |
| 5" | P5Q | 3.0 | 1" | 8,500 | 26,000 | 2W |
| 5" | P5T | 3.0 | | 10,500 | 32,000 | 2W |
| 6½" | P6Q | 3.0 | 1" | 8,500 | 26,000 | 3W |
| 6½" | P6T | 3.0 | | 10,500 | 32,000 | 3W |
| 8" | P8D | 2.3 | 1" | 6,200 | 24,000 | 4W |
| 8" | P8M | 2.3 | | 8,000 | 31,000 | 4W |
| 8" | P8G | 2.3 | | 10,000 | 39,000 | 4W |
| 10" | P10M | 2.3 | 1" | 8,000 | 31,000 | 6W |
| 10" | P10G | 2.3 | | 10,000 | 39,000 | 7W |
| 12" | P64 | 15.0 | 1½" | 12,500 | 140,000 | 12W |
| 18" | P84 | 10.0 | 2½" | 13,500 | 350,000 | 40W |

FROM the range of Celestion Loudspeakers most manufacturers are able to meet their requirements. The smallest model, a midget weighing 3½oz. is intended for small personal radios and the largest, capable of handling 40 watts, for public address purposes. Between these extremes, the range is balanced and well considered.

PUBLIC SALES

Several Loudspeakers of this range are available to the public in chassis form or housed in attractive cabinets. All enquiries for these must be directed to our sole wholesale and retail distributors, Cyril French Ltd.

SOLE DISTRIBUTORS

to the Wholesale and Retail Trades:

CYRIL FRENCH LTD.

29 High Street, Hampton Wick,
Middlesex. KINGSTON 2240

CELESTION LTD., KINGSTON-ON-THAMES SURREY PHONE: KINGSTON 5636-7-8-9

YOUR CHOICE for QUALITY

Manufacturers of high quality Broadcast Receivers and Radiograms designed for Home and the Export Market. The Export Models have fully tropicalised components, achieving unsurpassed short-wave performance.

Special dials supplied for any country

PRICES AND FULL PARTICULARS ON REQUEST

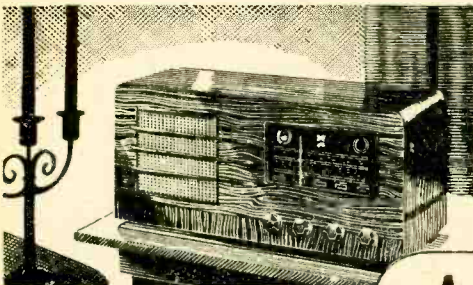

ALLANDER INDUSTRIES LTD.
48, Avenue St. Bridgeton, Glasgow, Scotland.

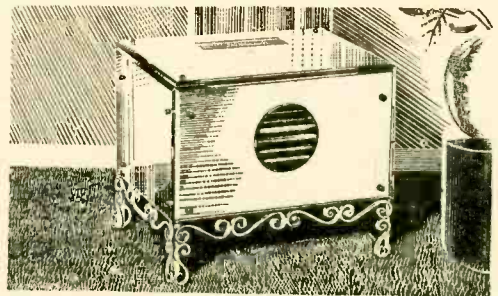

CHAIRSIDE MODEL A450

The housing of this Receiver is unique in that it is contained in a bevelled plate-glass mirror cabinet, fitted to a wrought iron framework finished in Cream enamel. It embodies all the latest technical developments for easy handling, range and clarity of reception, and provides not only a first-class radio but an attractive piece of furniture which can replace a Chairside Table and will harmonise with any surroundings.

SYMPHONY MODEL A420

This new Receiver embodies the very latest technique in construction. The cabinet is richly veneered in Walnut with a cross banding of Macassar Ebony. Clearly readable edge-lit dial with an 8 in. traverse magic eye and 2-gear control. Instant, unerring selection of the required frequency range. Automatic volume control and an I.F. trap are incorporated in the circuit. Sockets are provided for gramophone pick-up and extension speaker.

ALLANDER



YOUR 1948 GOOD RESOLUTION —SIMPLIFY SERVICING WITH TAYLOR EQUIPMENT

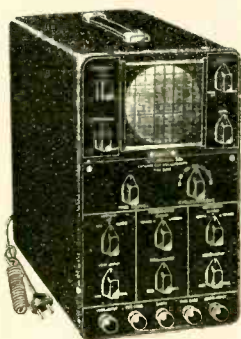

Model 30A. Cathode Ray Oscillograph. 3½ in. tube with green fluorescent screen. Linear Time Base from 10 to 10,000 cycles. A.C. Mains operated.

MODEL 30A. £29.10.0

H.P. TERMS : £2. 17. 0 Deposit and 11 monthly payments of £2. 16. 6.



MODEL 20A. £15.15.0

H.P. TERMS : £1. 10. 5 Deposit and 11 monthly payments of £1. 10. 2.



MODEL 45A. £22.0.0

H.P. TERMS : £2. 2. 2 Deposit and 11 monthly payments of £2. 2. 2.



MODEL 70A. £11.11.0

H.P. TERMS : £1. 2. 9 Deposit and 11 monthly payments of £1. 2. 1.



MODEL 85A. £19.19.0

H.P. TERMS : £1. 19. 0 Deposit and 11 monthly payments of £1. 18. 2.

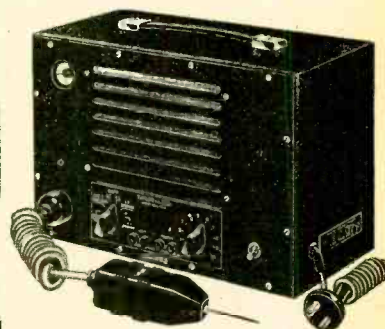

Model 20A. Taylor Circuit Analyser. Audio and Magic Eye Indication. Pentode Detector in Probe. Ideal for fault finding.

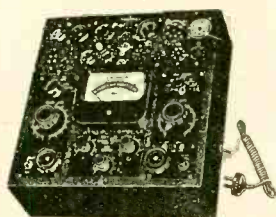

Model 45A. Taylor Valve Tester. All tests on over 2,500 types of British, American and Continental Valves.

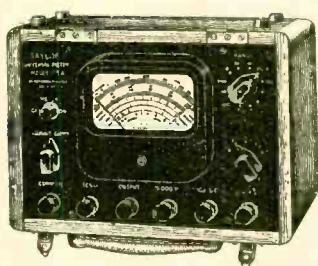

Model 85A. Universal Taylormeter. 90 Ranges. Sensitivity 20,000 ohms per volt A.C. and D.C.

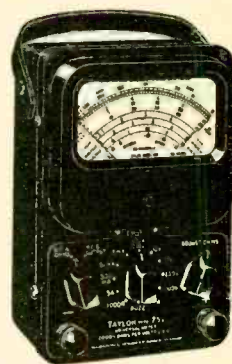

Model 70A. Universal Taylormeter. 50 Ranges. Sensitivity 1,000 ohms per volt. A.C. and D.C.

**IMMEDIATE DELIVERY
FOR MOST MODELS**



TAYLOR PRODUCTS INCLUDE: MULTIRANGE A.C. D.C. TEST METERS ● SIGNAL GENERATORS ● VALVE TESTERS ● A.C. BRIDGES ● CIRCUIT ANALYSERS ● CATHODE RAY OSCILLOGRAPHS ● HIGH AND LOW RANGE OHMMETERS ● OUTPUT METERS ● INSULATION TESTERS ● MOVING COIL INSTRUMENTS

TAYLOR ELECTRICAL INSTRUMENTS LTD
419-424 MONTROSE AVENUE, SLOUGH, BUCKS, ENGLAND

Telephone SLOUGH 21381 (4 lines)
Grams & Cables "TAYLINS" SLOUGH

Forty-Niner!



A hundred years ago communication between prospecting parties and civilization was slow, uncertain and often hazardous. Today a radio telephony link eliminates the difficulties imposed by distance, terrain and climate. Geological, seismic and other prospecting parties all over the world are specifying the 50 watts Redifon GR.49 as essential equipment. This efficient new short-wave radio telephone is very simple to operate, sturdily built and finished to withstand tropical conditions.

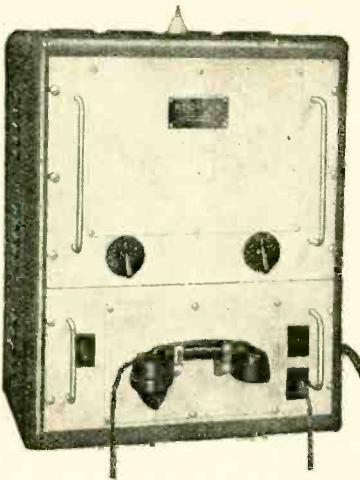

Redifon GR.49
Radio Telephone

Redifon Radio

Radio Communications Division
REDIFFUSION LTD., BROOMHILL ROAD, WANDSWORTH, S.W.18
 Designers and Manufacturers of Radio Communication and Industrial Electronic Equipment

Scientific RC 105

"Cyldon"

MICA DIELECTRIC TRIMMER Capacitors



Type No. 16



Type No. 14



Type No. 16G

SYDNEY S. BIRD & Sons, Ltd.
 CAMBRIDGE ARTERIAL ROAD, ENFIELD, MIDDX.
 Phone: Enfield 2071-2 Grams: Capacity, Enfield.

Our new
 Illustrated
 Catalogue
 is now
 available
 (6d. post free)

BERRY'S

(SHORT WAVE) LTD.

25, HIGH HOLBORN, LONDON, W.C.1
 (OPP. CHANCERY LANE) Tel.: HOLBORN 6234

And now . . .
the "DE LUXE"
Microgram!

For the
finest Record
Reproduction
in portable
form!



The "De Luxe" Model

The Collaro "DE LUXE" Microgram sets an even higher standard of faithful record reproduction . . . with its crystal-clear tone . . . ample volume and automatic stop, it is without doubt the finest Portable Electric Gramophone in the world—no wonder it attracted such widespread attention at Radiolympia!

See the "DE LUXE" Microgram in your dealer's showroom, and study its finer points! You'll recognise the Collaro high-grade workmanship . . . the new light-weight Crystal Pick-up . . . the 6½ inch Speaker, and you'll admire the handsome imitation lizard-skin case. Ask to hear it play your favourite records—you'll be amazed at the rich, mellow tones—the purity and faithfulness of the reproduction, superior to any other portable instrument you've ever heard before.

The **COLLARO**
"DE LUXE"
Microgram
Portable Electric Gramophone

Trade enquiries to
COLLARO LTD., Ripple Works, By-Pass Road, Barking, Essex.

Should your usual dealer not have a "DE LUXE" Microgram in stock when you call . . . just drop a line to Collaro Ltd. (address below) for illustrated literature which describes the Microgram in detail.

PRICES:

"DE LUXE MODEL" £19 19 0
Plus Purchase Tax, £6 9 8

STANDARD MODEL £16 16 0
Plus Purchase Tax, £5 9 3

Both the "DE LUXE" and Standard Models are suitably connected for A.C. mains supply of 200-250 volts at 50/60 cycles.

Telephone: Rippleway 3333

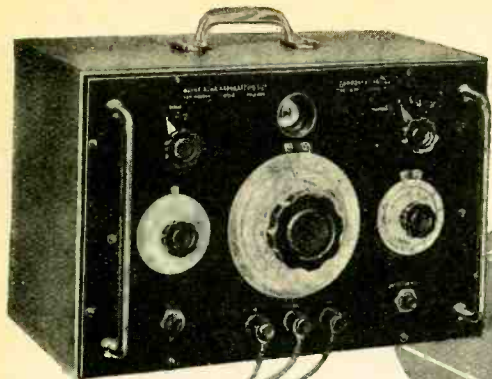

Measuring a condenser in circuit

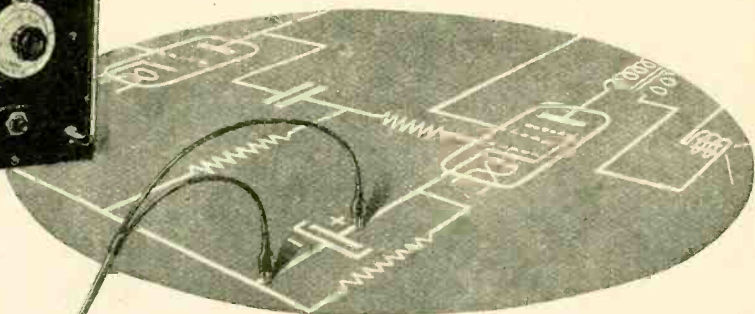

COMPONENT BRIDGE B101

5 pfd. to 500 mfd. - - in eight ranges
 5 ohms to 500 Megohms - - in eight ranges
 0.1 Hy. to 5,000 Hys. - in four ranges
 Leakage 0 to 1.5 m/a. Q: 0 to 30.
 Precision Comparator. Price 26 Gns.

To examine this cathode bypass condenser *in situ*, the Power Factor control is used to balance out the parallel resistance and the main scale will then give an accurate measurement of capacity — one of the many unusual facilities provided by this flexible instrument.

Wayne Kerr

WAYNE KERR LABORATORIES LIMITED, NEW MALDEN SURREY PHONE: MALDEN 2202

M. R. SUPPLIES Ltd.

offer only thoroughly reliable material, all brand new. Immediate delivery from stock. All prices nett.

SYNCHRONOUS ELECTRIC CLOCK MOVEMENTS. At last we are able to offer our post-war improved MR/222 movement. The perfect unit for construction of clocks to one's own design, dark-room and process-timing clocks, etc. Fitted spindles for hours, minutes and seconds hands and will drive hands up to 15 inches long. Approx. 3in. dia. Easy to mount in any clock-case, centre-fixing. With dust-cover and flex lead, ready for operation on 50 cycle mains, 200/250 volts, 37/6. (We anticipate that initial supplies will be readily sold—order early.)

VARIAC TRANSFORMERS. Essential for correcting mains voltage fluctuations in laboratories, processing, etc., and ensuring "striking" of fluorescent lighting. Manually operated, voltage being infinitely variable within limits stated. Model "A," input 200/240 v., output 220 v., loading 1.65 kva., £7/10 0. Model "B," input 200/250 v., output 230 v., loading 1.01 kva., £6/10 0 (despatch either 3/6).

BATTERY CHARGING KITS for construction of high-duty charger on one-third of usual price. Reliable M.R. quality components: S.T.C. Metal Rectifier (6-cells at 4 amps), 25/-, Mains Transformer, 200/240 v. to 8 and 14 v. at 5 amps, to suit, 38/6. Panel Mtg. Rotary Rheostat to suit, 26/-, Panel Ammeter, 3 1/2 in., 0.5 amps, 29/6. Suitable Steel case, ventilated, 7/6. The kit, from present stocks only, £6/6 0 carr. paid. (Or items sold separately.)

EXTRACTOR FANS (Also suitable for cooling) New Delco-Remy models from stock. Operation 200/250 v. A.C. Consumption only 25-watts. 8-inch, 65/6, 10 inch, 75/6 (desp. either 2/-). Also G.E.C. 8 inch for operation on 6/12 v. D.C. or 50 v. A.C., 35/- (We have suitable s/d transformers, 200/250 v. to 50 v. 1 amp. at 28/6.)

CENTRIFUGAL BLOWERS (G.E.C.) Operation 6/12 v. D.C. or 1b v. A.C. Intake 2 1/2 in., outlet 1 1/2 in., Height overall 8 1/2 in. Very powerful blast and suction, for air conditioning, electronic cooling, forges, etc., 57/6. (We have suitable s/d transformers, 200/250 v. to 15 v. 5 amps, at 38/6.)

DECADE RESISTANCE BOXES (by best precision makers). Units, 0/10, tens 0/100, with addition 100 ohms. (can be altered to multiplier). Fitted Turner m/coil Galvo. Switching for Wheatstone Bridge and other tests. In fine portable case, 16 by 7 1/2 by 6 inches, 65/- (des. 2/-).

EVERESHED "WEE-MEGGERS" The best portable insulation test instruments from stock. Pressure 500 v., reading 0/20 megohms and inf., with pocket and log books, £12/7/6

GRAMPLAN HIGH-FIDELITY SPEAKERS. The new 12 inch P.M. with curvilinear cone, alcomax magnet and die-cast chassels. Handling up to 12 watts, sensitive to 1 watt. Coil 15 ohms. A very satisfactory speaker, doing full justice to high-quality amplifiers, such as "W.W." £8/10 0.

NEW SENIOR PIEZO-CRYSTAL PICKUPS (R.A.I. under Brush licence) Employing very latest improved crystal cartridge, giving high output with level response 30/8,400 c/s. Ball-bearing pivot, handsome moulded arm, fitted Centralab volume control (a great convenience), 65/-. **ROTHERMEL PERMANENT JEWEL NEEDLES**, over 2,000 playings, 11/-.

M/COIL HEADPHONE SETS, with M/Coil Hand Microphone, best type, new, 15/-.

INSTRUMENT RECTIFIERS, full-wave, 1 m.a. and 5 m.a., either 5/-.

P.A. SPEAKERS. Reflected horn type with 10 watt P.M. m/coil Pressure Unit, 16 ohms. Imp. Flare 12in. long, 1 1/4 in. dia. On swivel mount with pillar, ideal for mobile use, £7/12/8 (des. 5/-) **STEEL TRIPODS** for these and other P.A. Speakers, ext. to 12in., very rigid, 55/- (des. 3/6). A few Reflected Horns as described, less unit (standard P.A. thread) at £4 10/0 (des. 5/-).

Please include sufficient for packing and despatch.

M. R. SUPPLIES Ltd., 68, New Oxford Street, London, W.C.1
 Telephone: MUSeum 2958



FOR THE RADIO SERVICEMAN DEALER AND OWNER

The man who enrolls for an I.C.S. Radio Course learns radio thoroughly, completely, practically. When he earns his Diploma, he will KNOW radio. We are not content merely to teach the principles of radio, we want to show our students how to apply that training in practical, every-day radio service work. We train them to be successful.

Write to the I.C.S. Advisory Dept. stating your requirements. Our advice is free.

-----You may use this coupon-----
INTERNATIONAL CORRESPONDENCE SCHOOL Ltd.

DEPT. 38, INTERNATIONAL BUILDINGS, KINGSWAY, LONDON, W.C.2

Please explain fully about your instruction in the subject marked X.

Complete Radio Engineering Radio Service Engineering
 Radio Service and Sales Elementary Radio

And the following Radio Examinations:—

British Institution of Radio Engineers
 P.M.G. Certificates for Wireless Operators
 City and Guilds Telecommunications
 Wireless Operators and Wireless Mechanics, R.A.F.

I.C.S. students for Examinations are coached till successful.

Name..... Age.....

Address.....



Designed to suit the circuit

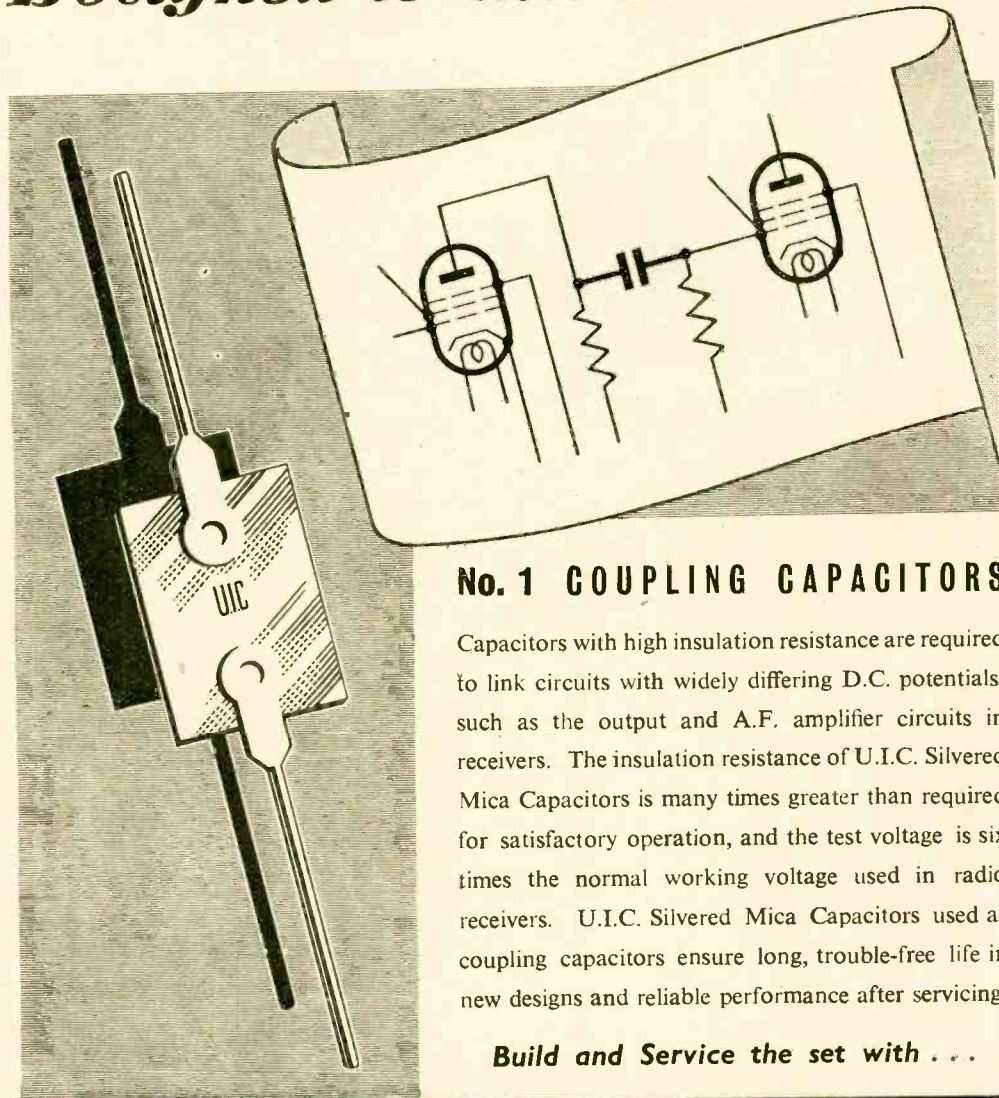

No. 1 COUPLING CAPACITORS

Capacitors with high insulation resistance are required to link circuits with widely differing D.C. potentials, such as the output and A.F. amplifier circuits in receivers. The insulation resistance of U.I.C. Silvered Mica Capacitors is many times greater than required for satisfactory operation, and the test voltage is six times the normal working voltage used in radio receivers. U.I.C. Silvered Mica Capacitors used as coupling capacitors ensure long, trouble-free life in new designs and reliable performance after servicing.

Build and Service the set with . . .

U.I.C. HIGH STABILITY CAPACITORS

UNITED INSULATOR CO. LTD. OAKCROFT RD. TOLWORTH SURBITON SURREY

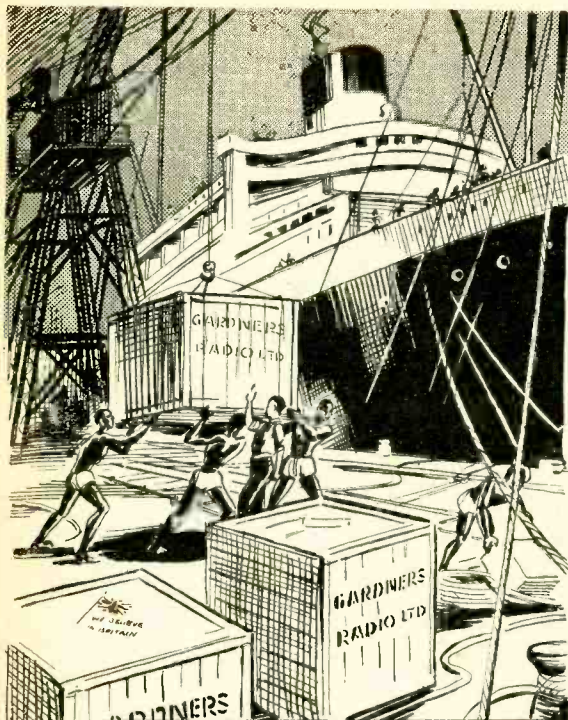

IN THE TROPICS

Back they go! Back to the tropics. Back to the grim testing grounds of 1942-45. Remember—the arduous conditions of the Burma campaign? But happily—very very happily—with a difference—contributing to the export drive, instead of war.

These "Somersford" Transformers and Chokes, being shipped to the tropics, are absolutely as standard, the robust construction and technical superiority being ideal for withstanding the hazards of steaming humidity.

You may select exactly the same from the "Somersford" range.

It is no accident that "Somersford" Transformers are constantly used by the National Research Establishments, together with Industrial and University Laboratories.

Distributing Agents:—

INDIA: J. V. Mehta & Co., Opera House, Tram Terminus, BOMBAY, 4.

BURMA: E. Ruttonsha (Burma) Ltd., 77 Phayre Street, RANGOON.

MALAYA: Swee Electro Radio Service Co. Ltd., 5 & 7 Bukit Bintang Road, KUALA LUMPUR.



GARDNERS

"SOMERSFORD"
TRANSFORMERS

WORLD-FAMOUS FOR DEPENDABILITY

GARDNERS RADIO LTD., Somersford, Christchurch, Hants.

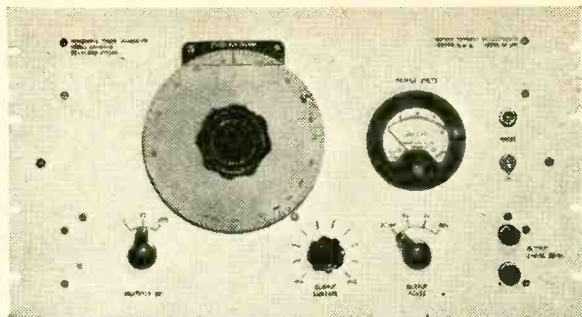

RESISTANCE TUNED OSCILLATOR. Model LO 63-B.

THIS is a precision audio oscillator having a harmonic content of less than 1% and a frequency stability of better than .25%. The circuit employs an entirely new principle. The frequency calibration is direct reading over the entire range. A calibrated attenuator and output meter are incorporated. Standard range 30 cycles to 33,000 cycles. Other models available from 1 cycle to 100,000 cycles.

For particulars of this and our full range of measuring instruments, write to:—

BRITISH PHYSICAL LABORATORIES HOUSEBOAT WORKS, RADLETT, HERTS

Telephone: Radlett 5674-5-6

A Wise Investment!

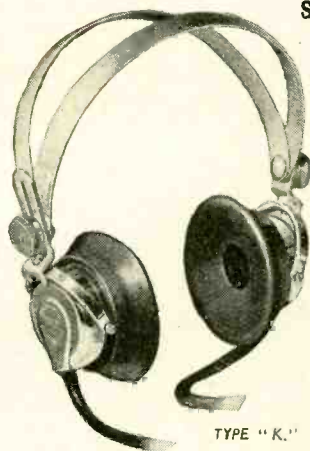

TYPE "K."

S. G. BROWN, Type 'K'
Moving Coil Headphones, with the following outstanding characteristics, supply that High Fidelity Reproduction demanded for DX work, monitoring and laboratory purposes, etc.

NOTE THESE CHARACTERISTICS.

D.C. RESISTANCE, 47 Ohms.

IMPEDANCE, 52 Ohms at 1,000 c.p.s.

SENSITIVITY, 1.2×10^{-12} Watts at 1 kc. = .0002 Dyne/cm².

Descriptive Literature on request.

PRICE **£5.5.0** PER PAIR.

Supplies now available.

Order from your Local Dealer.

For details of other S. G. Brown Headphones (prices from 25/- to 60/-) ask for illustrated Brochure "W.W."

HEADPHONES WHICH UPHOLD BRITISH PRESTIGE.

Phone: ACOrn 5021.

S. G. Brown, Ltd.

VICTORIA RD., NORTH ACTON, LONDON, W.3



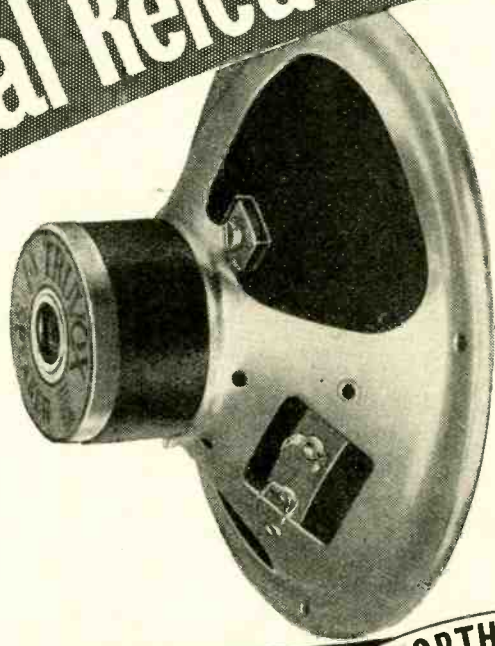



General Release-



FORTHCOMING PRODUCTIONS

"Monobolt" speakers, the first of the new Truvox radio range, are now available from all radio dealers. Quality enthusiasts, and all those who want "the best," will welcome this news. If you require fuller details than are given below—a postcard will bring them.

| | | | |
|--------------|-------|--------------|---------|
| Model BX 50 | 5in. | 8,500 lines | £1 1 0 |
| Model BX 52 | 5in. | 10,000 lines | £1 4 6 |
| Model BX 60 | 6½in. | 8,500 lines | £1 2 6 |
| Model BX 62 | 6½in. | 10,000 lines | £1 6 0 |
| Model BX 80 | 8in. | 8,000 lines | £1 4 0 |
| Model BX 82 | 8in. | 10,500 lines | £1 10 0 |
| Model BX 100 | 10in. | 8,000 lines | £1 10 0 |
| Model BX 102 | 10in. | 10,500 lines | £1 17 6 |

| | |
|--|---|
|  P.A. EQPT |  HIGH FIDELITY PICKUPS |
|  REFLEX SPEAKERS |  WAFER SPEAKERS |
|  AUDITORIUM LOUDSPEAKERS |  EXTENSION LOUDSPEAKERS |

New products, as illustrated above, are well under way. Full details will be announced as they become available.

TRUVOX

TRUVOX ENGINEERING CO., LTD., EXHIBITION GROUNDS, WEMBLEY, MIDDLESEX.



New in P.A. equipment...



The new P.A.203, an improved version of the well-known P.A.20 Portable Amplifier, embodies many interesting features. These include: Increased gain; improved output transformer, giving a true 20 watts distortionless output, with tappings for 7.5, 15 and 500 ohm (100 v. line) outputs; 600 ohm input for B.S.R. Ribbon Microphone type R.B.M. 1 (illustrated above) and provision for working the B.S.R. Radio Feeder unit.

Supplied in an attractive case and available for immediate delivery. Full details available on request. Also send for details of Recording Amplifier R.1.

BIRMINGHAM SOUND REPRODUCERS LTD.

CLAREMONT WORKS, OLD HILL, STAFFS. PHONE: CRADLEY HEATH 6212-3
LONDON OFFICE: 115 GOWER STREET, W.C.1. PHONE: EUSTON 7515

EXCELLENT SELLING LINE

High Fidelity S.H.E.F.I. Moving Coil Pick-ups

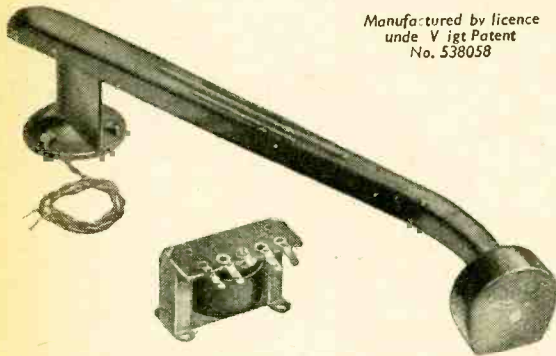

Manufactured by licence
under V igt Patent
No. 538058

Retail Price, including Transformer, in Walnut and black plastic finish - - **£2.0.0**
Plus 10/4d. Purchase Tax. Generous Trade Discounts.
Ivory finish, £2.3.8. Plus 11/7d. Purchase Tax.

The only Moving Coil Pick-up with high level output. Will operate average receiver. No Pre-amplifier No Shielded Transformer. No Hum Problem. Genuine High Fidelity reproduction flat to 12,000 c.p.s. with bass boost below 250 c.p.s. to allow for drop in recording level of 6 db. per octave. This is one of many other electrical appliances. Overseas enquiries are invited. Agency arrangements may be made

Visit Stand 82 Grand Hall, Ideal Home Exhibition, Olympia.
BROOKS & BOHM LTD.,
90, VICTORIA ST., LONDON, S.W.1. VIC. 9550-1441.

RAYTHEON CONTRIBUTIONS to development of Hearing Aid

Why batteries can now be little instead of BIG



A big factor in making the modern Hearing Aid such a neat, compact instrument is the great reduction made possible in size of batteries. In 1939 valves used in the average Hearing Aid drew almost one-third of a watt from the "A" battery. Today, thanks to Raytheon developments in valve design and construction, drain on the "A" battery is 80 per cent less, battery life ten times greater, so that batteries can now be much smaller, with many times the life. Because of this and other important developments Raytheon is supplying more than 90 per cent of all Hearing Aid valves in use today.

Ask for complete information. Address your inquiry to Submarine Signal Company (London) Ltd., Artillery House, Artillery Row, London, S.W.1, England, or to:

South African Distributors:
Lynch-Wilde (Africa) (Pty) Ltd., Jo'burg.

RAYTHEON
INTERNATIONAL DIVISION
60 EAST 42nd STREET
NEW YORK 17, N.Y., U.S.A.
Excellence in Electronics

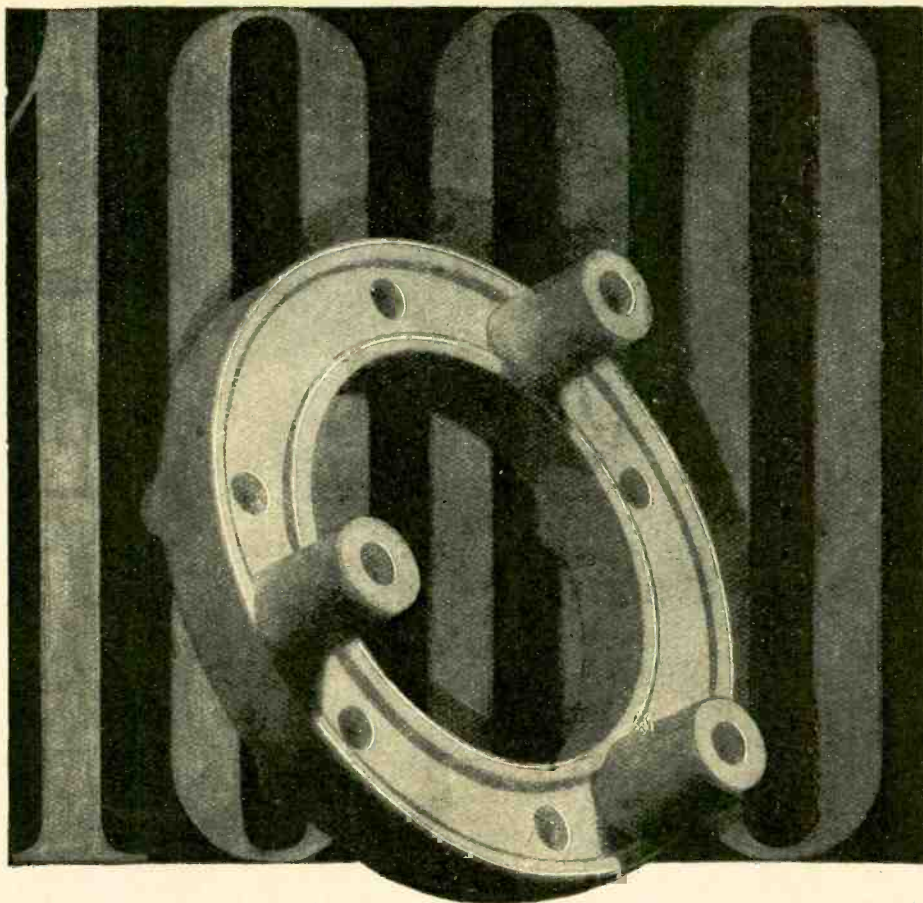

ONE IN A THOUSAND

Fifteen years ago we introduced the first British-made low-loss ceramic. Today the range of FREQUENTITE components covers more than a thousand pieces of every shape and size.

With such a store of manufacturing experience we are able to offer advice backed by practical knowledge on your insulation problem. Please consult us before you finalize your design.



STEATITE & PORCELAIN PRODUCTS LIMITED

Head Office ; Stourport-on-Severn, Worcs. Telephone: Stourport 111. Telegrams : Steatins, Stourport.

S.P.17

Presenting the New Model D

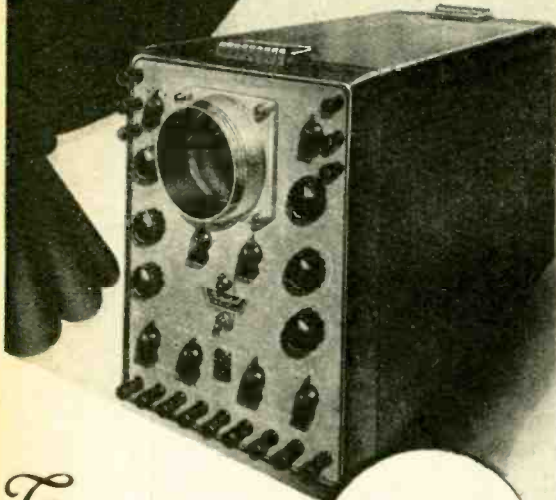

The Type 1684 series of Oscilloscopes is already well known. The new Model retains the desirable features of this series—d.c. shift controls, response flat to video frequencies, d.c. coupled symmetrical amplifiers on both axes, semi-automatic synchronisation of the time base, etc. It incorporates many new features of design, both electrical and mechanical. One such improvement is that the grids of the input stages of both amplifiers are available at Earth potential enabling the instrument to be used more easily for d.c. measurement.

PRINCIPAL FEATURES

- ★ TUBE 3½ in. diam. Blue, green or delay screen.
- ★ AMPLIFIERS. D.C. to 3 Mc/s 18 mV. r.m.s. per cm. or D.C. to 1 Mc, 6 mV per cm. Symmetrical or asymmetrical input. X and Y amplifiers are similar.
- ★ TIME BASE. 0.2 c/s to 150 kc/s. Variable through X amplifier 0.2 to 5 screen diameters.
- ★ ACCESSORIES. Camera, telescopic light shield, ruled graticule.



Fuzzehill LABORATORIES LTD

BOREHAM WOOD, HERTS
Telephone: ELSTREE 1137

Miniature or midget

ACTUAL SIZE

XY 1-4A

XW 0-75A

NEW TYPES FOR
MIDGET RECEIVERS
HEARING AIDS
METEOROLOGICAL
INSTRUMENTS
ETC.

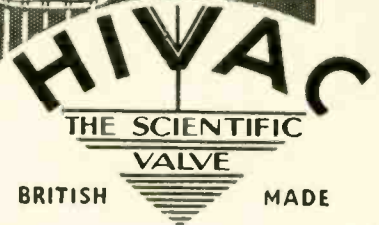

HIVAC LIMITED Greenhill Crescent. Phone. HARROW 0895
Harrow on the Hill, Middx.

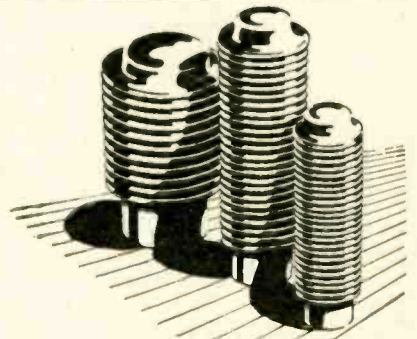

★ FOR MEN ONLY interested in

Seamless, one-piece, metal bellows... formed in one continuous operation by a process unique in this country, with a uniformity of wall-thickness unobtainable by any other method... No annealing, no spinning, no localised strain or thinning; none of the limitations of metallic diaphragms.

These bellows, though no thicker than paper—the walls range from 4/1000" to 7/1000"—are tough, resilient, and combine the characteristics of a coiled compression spring, a packless gland, and a non-ferrous hermetically sealed container. Every bellows is pretested during forming and has a high degree of uniformity of life, performance and reliability in operation. Available in root diameters of 1" to 3", outside diameters 1½" to 4½".

Write for the Hydroflex Brochure Y.

- ★ Flexible couplings for condensers
- Refrigeration
- Temperature control
- Air compressors
- Water pumps
- Paper machines
- Gland seals
- Thermostatic & pressure operated appliances

Drayton Hydroflex METAL BELLOWS

Drayton Regulator & Instrument Co. Ltd., West Drayton, Mdx.

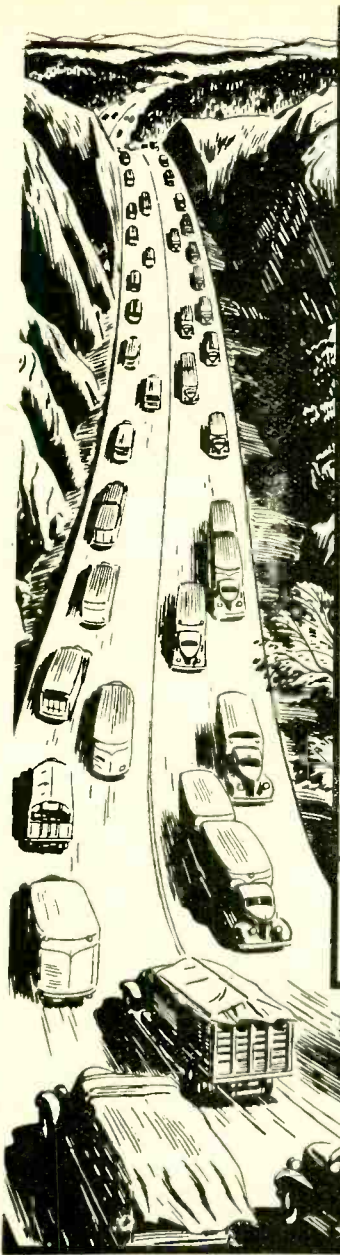

TRADE MUST FLOW TWO WAYS

says **Canada**

And, in fact, Canadian trade does flow two ways. Total exports and total imports are closely balanced in value.

To sellers abroad, Canada affords a large and varied market for imported goods.

To buyers abroad, Canada offers a broad range of both primary and manufactured products.

If you wish to buy or sell in Canada, consult your nearest Canadian Trade Representative. He is at your service in any of the following countries :

ARGENTINA • AUSTRALIA • BELGIAN CONGO • BELGIUM • BRAZIL • CHILE
CHINA • COLOMBIA • CUBA • EGYPT • FRANCE • GREECE • GUATEMALA • HONG
KONG • INDIA • IRELAND • ITALY • JAMAICA • MALAYAN UNION • MEXICO
NETHERLANDS • NEWFOUNDLAND • NEW ZEALAND • NORWAY • PAKISTAN
PERU • PORTUGAL • SOUTH AFRICA • SWEDEN • TRINIDAD • UNITED KINGDOM
UNITED STATES • VENEZUELA

THE FOREIGN TRADE SERVICE
DEPARTMENT OF TRADE AND COMMERCE

OTTAWA



CANADA

WORLD
TRADE
HIGHWAY

IMPORTS
EXPORTS

ATTEND THE
CANADIAN INTERNATIONAL TRADE FAIR

Toronto, Canada, May 31 - June 12, 1948

See and examine the trade offerings of the world—on display in Canada in 1948. Compare the finest goods of many nations—of many industries. Plan now to attend the Canadian International Trade Fair, or to send a representative. Get full details, including information on travel and accommodation, from your nearest Canadian Trade Representative.



GOODMANS *Loudspeakers*

The models illustrated here are part of a range which includes loudspeakers designed for every conceivable purpose and built to the exacting standards which have made the name "Goodmans Loudspeakers" synonymous with fidelity in reproduction and robust efficiency.

12-inch—Type T2/1205/15. The famous medium-heavy duty speaker. Suitable for general P.A. duties, small halls, and radiograms.

Impedance 15 ohms at 400 c.p.s. Total Flux . . . 145,000 maxwells
Peak A.C. Input . . . 15 watts Fundamental Resonance . 75 c.p.s.

15-inch—Type T10/1501/15. An ideal reproducer for heavy duty P.A. systems, medium halls, etc.

Impedance 15 ohms at 400 c.p.s. Total Flux . . . 215,000 maxwells
Peak A.C. Input . . . 25 watts Fundamental Resonance . 70 c.p.s.

18-inch—Type T11/1801/6. The loudspeaker for very high power amplifier systems, large theatres, and outdoor use.

Impedance 6 ohms at 400 c.p.s. Total Flux . . . 267,000 maxwells
Peak A.C. Input . . . 50 watts Fundamental Resonance . 55 c.p.s.

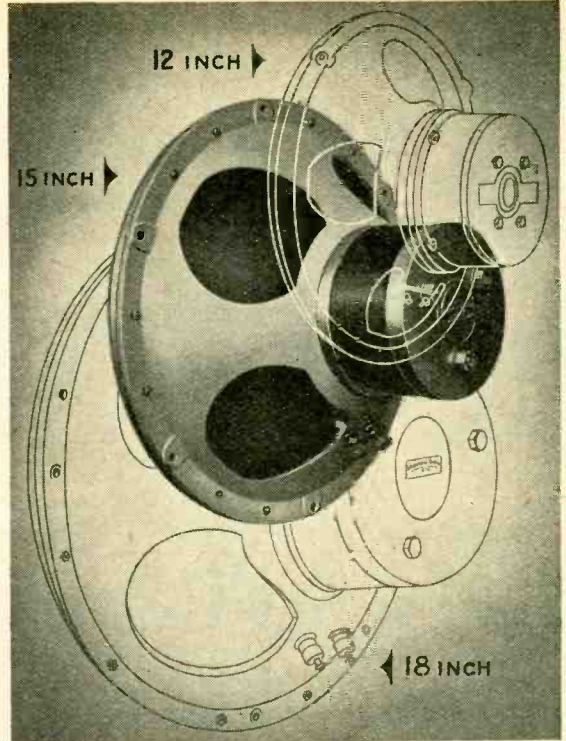

GOODMANS INDUSTRIES LTD.

Lancelot Road, Wembley, Middx. Phone: Wembley 4001 (9 lines)



*Products of
Quality & Reliability*

**MAINS TRANSFORMERS
A. F. TRANSFORMERS
SMOOTHING CHOKES
THERMAL
DELAY SWITCHES
POWER RESISTANCES**

Made by

OLIVER PELL CONTROL LTD

Telephone: WOOLWICH 1422
CAMBRIDGE ROW · WOOLWICH S E 18

DAWE INSULATION TESTER

TYPE 402 B



**DIRECTLY
MEASURES
10,000 megohms
at low voltage.**

A compact, highly sensitive instrument for measuring Insulation Properties and Leakage Resistance without destructive breakdown; also suitable for Moisture determinations. A guard circuit is provided for eliminating surface leakages:

Range: 0.1 MΩ to 10,000 MΩ.
Test Potential: Less than 50 volts.
Power Supply: Self-contained dry batteries.
Dimensions: 4 1/2" x 7 1/2" x 4" deep.

Particulars on request to: — **DAWE INSTRUMENTS LIMITED,**
130, UXBRIDGE ROAD, HANWELL, W.7. EALING 6215.

MAZDA

HIGH VOLTAGE RECTIFIER

19.H.1



This High Vacuum Half Wave Rectifier is now available for use in Industrial or Amateur Electronic Equipment. Its main characteristics are :

| | |
|-------------------------------------|-------------|
| FILAMENT VOLTAGE | 4.0 v. |
| FILAMENT CURRENT | * 2.0 A. |
| MAX. PEAK INVERSE VOLTAGE (Working) | 15 KV |
| MAX. PEAK INVERSE VOLTAGE (No Load) | † 17.5 KV |
| MAX. PEAK ANODE CURRENT | 600 mA |
| MAX. MEAN ANODE CURRENT | 75 mA |
| MAX. VALUE OF RESERVOIR CONDENSER | 1.0 μ F |
| MIN. SURGE LIMITING RESISTOR | 2,500 ohms. |
| MAX. OVER-ALL LENGTH | 210 mm. |
| MAX. DIAMETER | 51 mm. |

LIST PRICE

£1.2.6

* The filament must be switched on for 10 seconds before the anode voltage is applied.

† This rating is absolute and must not be exceeded in service.

THE EDISON SWAN ELECTRIC COMPANY LIMITED

RADIO DIVISION

155 CHARING CROSS ROAD, LONDON, W.C.2

**10 to
310
mcs.**

- Light Weight 36 lbs.
- Negligible Stray Field.
- Frequency Calibration 1%
- Modulation 30% sine wave 1,000~ and pulsed 50/50 square wave at 1,000~.
- Attenuation Max. error at 300 mcs. ± 2 dB
- Precision Slow-Motion Dial.
- Wide Range, 10-310 mcs.
- Compact 12½ in. x 13½ in. x 7½ in.
- Dual-Power Supply 200-250v., 40-100~ 80-v., 40-2000~

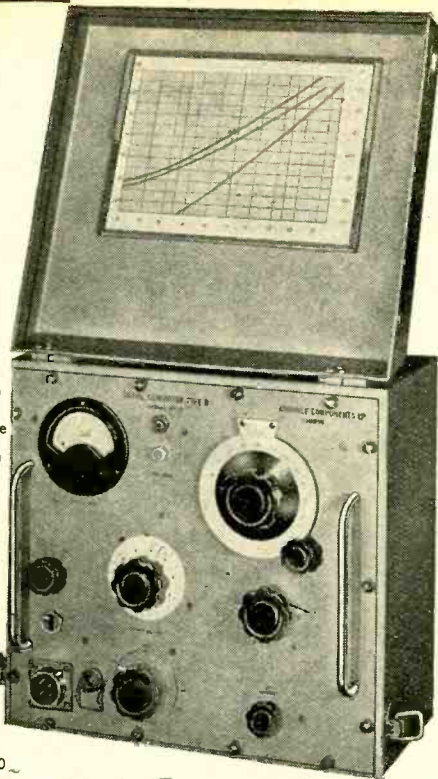

**"Advance"
Signal Generator
type D.1.**

This "ADVANCE" Signal Generator is of entirely new design and embodies many novel constructional features. It is compact in size, light in weight, and can be operated either from A.C. Power Supply or low-voltage high-frequency supplies.

An RL18 valve is employed as a colpitts oscillator, which may be Plate modulated by a 1,000-cycle sine wave oscillator, or grid modulated by a 50/50 square wave. Both types of modulation are internal, and selected by a switch. The oscillator section is triple shielded and external stray magnetic and electrostatic fields are negligible. Six coils are used to cover the range, and they are mounted in a coil turret of special design. The output from the R.F. oscillator is fed to an inductive slide wire, where it is monitored by an EA50 diode. The slide wire feeds a 75-ohm 5-step decade attenuator of new design. The output voltage is taken from the end of a 75-ohm matched transmission line.

The instrument is totally enclosed in a grey enamelled steel case with a detachable hinged lid for use during transport.

Price £80

Delivery ex Stock.

Write for descriptive Leaflet.

ADVANCE COMPONENTS, LTD.
BACK ROAD, SHERNHALL STREET,
WALTHAMSTOW, LONDON, E.17.

Telephone: Larkwood 4366-7.



... is it Rotary or Pushbutton or Slider? Is it wanted for circuit selection, band selection, tap switching? Is it for a new design or in quantities for a well proved circuit?

Whatever it is — the answer is always OAK! The basic design of all Oak switches is one of strength and efficient functioning, including such exclusive features as the double-contact clip and the floating rotor, ensuring self-alignment of each section.



BRITISH N.S.F. CO. LTD., Keighley, Yorkshire
(Sole Licensees of OAK Manufacturing Co., Chicago)
A.B. METAL PRODUCTS LTD., Feltham, Middx.
(Sub-Licensees of N.S.F.)
The only Manufacturers of OAK Switches under Patent Nos. 478391 & 478392

TRANSMITTING CONDENSERS

which can be used at high plate potentials.

A long felt need has been met by the production of this Raymart range of transmitting condensers which can be used at high plate potentials and which are reasonable in price.

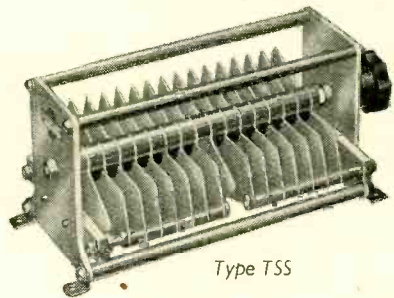

| TYPE | CAPACITIES | | Air Gap | PRICE |
|----------------|------------|--------------------|---------|---------|
| | Max. | Min. | | |
| TSS100D | 109.9 | 21.7 (1st Section) | .150in. | £3 5 0 |
| TSS50D | 111.4 | 22.2 (2nd Section) | | |
| | 49.4 | 12.9 (1st Section) | | |
| | 50.4 | 13.2 (2nd Section) | .150in. | £2 15 0 |
| TX100S | 114.0 | 16.6 | .080in. | £2 5 0 |
| TX100DS | 116.8 | 26.2 | .150in. | £2 15 0 |
| TX50DS | 55.8 | 16.8 | .150in. | £2 5 0 |

The measurements quoted above are those obtained on the prototypes when measured on a highly sensitive bridge at the laboratory of the Birmingham University.

When writing us don't forget to send S.A.E. for copies of our latest Lists "W.W."

RAYMART LIMITED
48 HOLLOWAY HEAD, BIRMINGHAM, 1
Telephone Midland 3254.

CAPACITORS

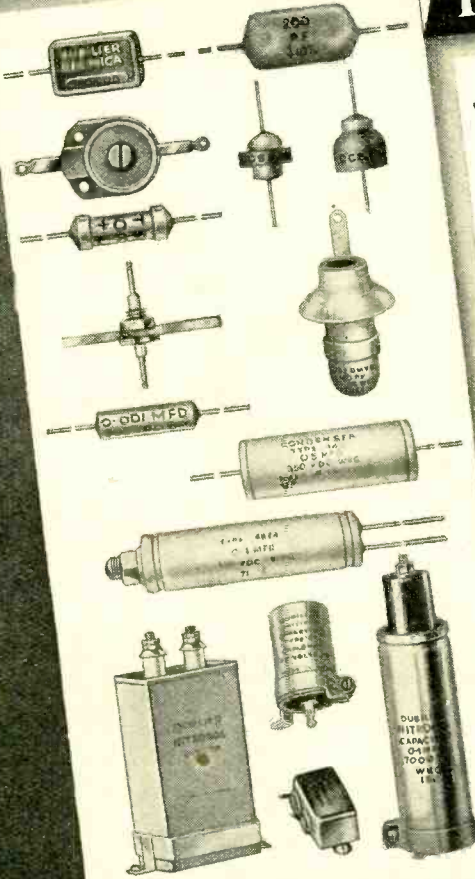

RESISTORS

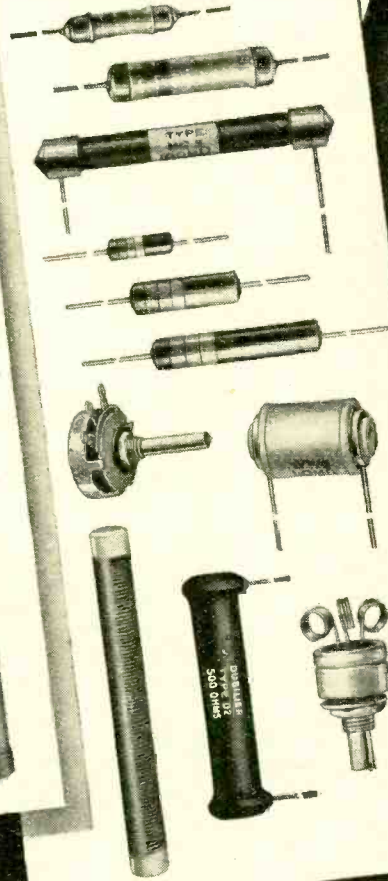

FOR more than 30 years, radio and electrical designers and engineers in all parts of the world have found their most exacting requirements met by the unrivalled Dubilier ranges of capacitors and resistors, renowned for their constancy and complete reliability under the most arduous operating conditions. These capacitors and resistors, so important in Radio, Radar and Television equipment, are being continuously developed and extended in order to provide for every conceivable application.

Dubilier capacitors and resistors owe their unvarying quality, technical excellence and high degree of stability to the close control which is maintained throughout all stages of their manufacture.

Full technical data and prices supplied upon request.

DUBILIER

CONDENSER CO. (1925) LTD.

DUBILIER CONDENSER CO. (1925) LTD., DUCON WORKS, VICTORIA ROAD, NORTH ACTON, W. 3
 Telephone : Acorn 2241 (5 lines) Telegrams : Hivoltcon, Phone, London
 Cables : Hivoltcon, London Marconi International Code
 D12A

*The better they are made
the more outstanding the results*

MADE IN THREE PRINCIPAL MATERIALS.

FREQUELEX. An insulating material of low Dielectric Loss, for Coil Formers, Aerial Insulators, Valve Holders, etc.

PERMALEX. A High Permittivity Material. For the construction of Condensers of the smallest possible dimensions.

TEMPLEX. A Condenser material of medium permittivity. For the construction of Condensers having a constant capacity at all temperatures.

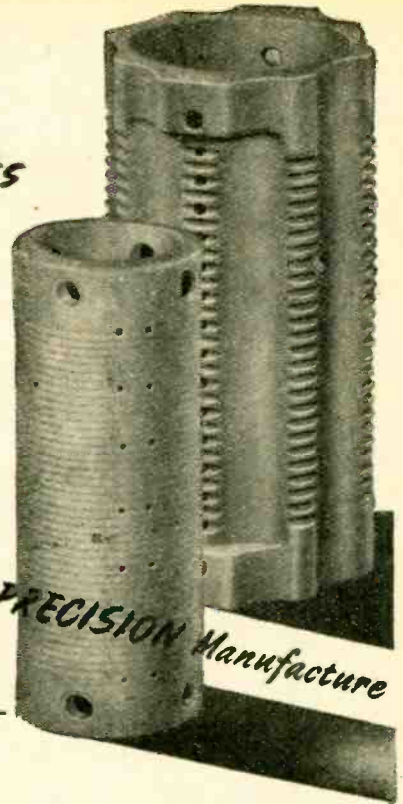

Bullers

Specialize in PRECISION Manufacture



BULLERS LOW LOSS CERAMICS

BULLERS LTD., 6, Laurence Pountney Hill, London, E.C.4. Phone : Mansion House 9971 (3 lines)
Telegrams : "Bullers, Cannon, London."

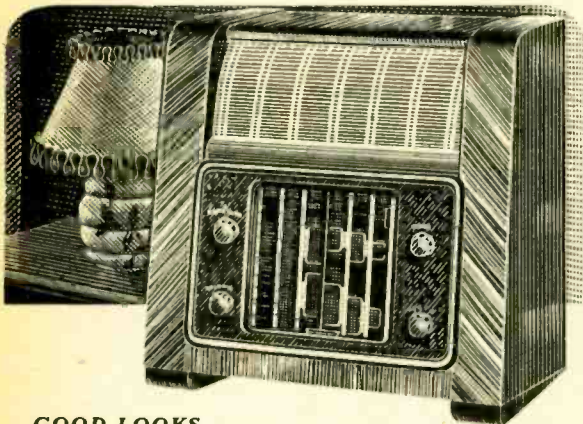

GOOD LOOKS

**GOOD LISTENING WITH THE NEW
TABLE MODEL "4756" **AMBASSADOR****

BRIEF SPECIFICATION : 5 valve 6 waveband A.C. Superhet. Electrical Bandspreading on principal S.W. Bands. New design output circuit giving exceptional wide frequency response. A really outstanding receiver for Short Wave listeners who also appreciate quality reproduction.

£23 PLUS TAX

AMBASSADOR RADIO WORKS
HUTCHINSON LANE, BRIGHOUSE, YORKS.

The Roberts' Portable Valve & Circuit Analyser



Gives . . .

- simultaneous measurement of current and voltage at any electrode of any valve without removing chassis from cabinet or disconnecting in any way. Also measures resistance between any electrode and ground.
- Eleven current ranges—500 micro-amp to 2.5 amp—AC and DC.
- Seventeen voltage ranges—2.5 volts to 1,000 volts—AC and DC. (2,000 ohms per volt).
- 3 resistance ranges—0 to 3,000, 50,000 or 500,000 ohms. Can also be used as an ordinary universal meter.
- Best materials and workmanship. Guaranteed 12 months.
- Dimensions : 12" x 12" x 5 1/2"; weight 9 lbs.

Manufactured by

LONDON SOUND LABORATORIES LTD
MAKERS OF QUALITY ELECTRONIC TEST EQUIPMENT
40 SOUTH MOLTON LANE · BOND STREET · LONDON, W.1

Webb's FOR DIVERSITY OF STOCK

ANTIFERENCE AERIAL EQUIPMENT

recommended and stocked by Webb's Radio

THE "V.R.A." AERIAL

The V.R.A. aerial is designed to meet the need for a good outdoor aerial where no electrical interference is present and a horizontal span is impractical or too conspicuous. Model VRA201 illustrated, includes wall mounting bracket, 15ft. vertical aluminium alloy rod and 60ft. downlead.

List Price 50/-
Alternative model VRA 202 (with chimney lashing equipment in place of wall mounting bracket).

List Price 60/-.

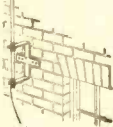

THE "EXSTAT" (Regd.)

The standard anti-static aerial for vertical or horizontal mounting. Easy to install and definitely the best signal to noise ratio ever obtained with an anti-interference aerial. "EX-STAT" Kit, Cat. ASA 112 (as illustrated) comprising two transformers, 20 yards screened cable, 15ft. vertical rod, with mounting bracket, and complete equipment for lashing to chimney stack.

List Price £7/3/0.

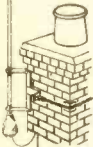

THE "ARNINE" SHORT WAVE AERIAL

An entirely new design of short wave aerial, constructed throughout in polythene. Aerial span and down-lead consist of twin parallel feeders of 300 ohm. impedance Suitable for transmission or reception. Power Loading capacity 1.9 Kw. at 7 Mc/s. and .9 Kw. at 14 Mc/s.

Model FDA 20 (for frequencies up to 14 Mc/s).
List Price £3/2/6.

Model FDA 40 (for frequencies up to 7 Mc/s).
List Price £3/12/6.

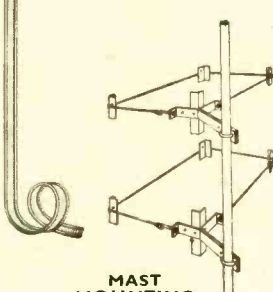

MAST MOUNTING BRACKETS

Model LSG/2 illustrated is suitable for erecting masts up to 20 feet in length.

List Price complete as illustrated, 40/- (mast extra).
Model LDG/1 (similar, but with single lashing model. List Price complete 30/-).
Surface Mounting Brackets, Model SMD/2.
List Price complete, 20/-.

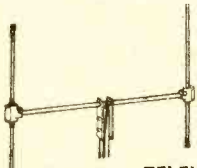

TELEVISION AERIALS

Seven alternative types from which to choose. All models have aluminium antenna and reflector rods, and are designed for ease of installation.

EDDYSTONE "640" COMMUNICATIONS RECEIVER



CONTINUOUS COVERAGE
FROM 31—1.7 Mc/s. WITH
ELECTRICAL BANDSPREAD throughout

An efficient general purpose short-wave receiver, designed to meet the exacting requirements of Amateur-Band Communications:

- Coverage 31 to 1.7 Mc/s.
- Electrical Bandsread throughout range.
- Eight Valves (plus rectifier).
- One R.F. and Two I.F. Stages.
- Efficient Noise-limiter.
- 10, 20, 40, 80 and 160 metre Amateur Bands calibrated.
- Beat Frequency Oscillator.
- Fly-wheel Control on Bandsread.
- Vacuum mounted Crystal filter.
- Adaptor for Battery Operation.

The "640" has outstanding signal/noise ratio and extremely good image rejection. Provision for external connection of "S" Meter.

PRICE **£39.10.0** NO PURCHASE TAX

THE "640" IS AVAILABLE FROM STOCK AT WEBB'S

★ COMMUNICATION RECEIVER REPAIRS

Webb's Service Department can undertake the complete overhaul and alignment of all recognized British and U.S.A. Receivers. Prompt attention ensured.

WEBB'S Radio

14, SOHO STREET, OXFORD STREET, LONDON, W.1.

Telephone: GERrard 2089

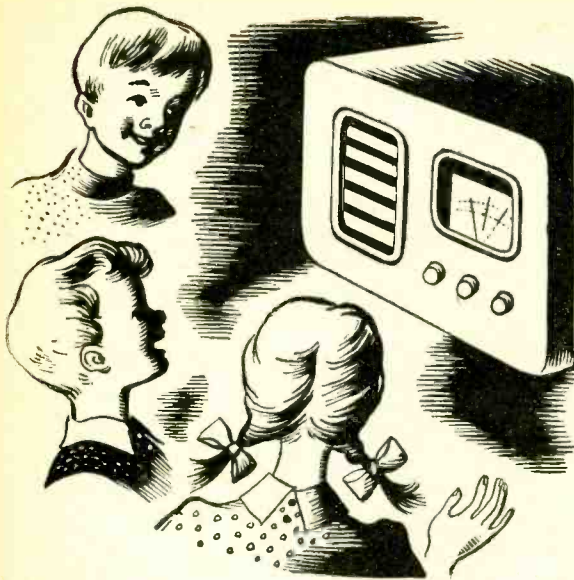

*They'll never miss
a minute of
CHILDREN'S HOUR
if you rely on*

Exide
H.T. ACCUMULATORS
AND
Drydex
H.T. BATTERIES

ISSUED BY
THE CHLORIDE ELECTRICAL STORAGE COMPANY LIMITED
EDX9A

LONG RANGE LISTENING
—with any Set!

Throughout the house, if necessary—certainly for the kitchen and by the bedside for hearing all your favourite programmes when it is not convenient to be where you keep your receiver. This is something you should have in this modern age—it can be obtained easily by simply plugging a superlative Stentorian Speaker into the receiver. In handsome wooden cabinets of acoustic design. Prices from 39/6d. with 5" speaker, to £5.15.6d. with 9" speaker and matching transformer.

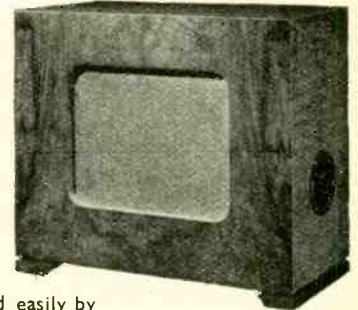

WB *Stentorian*

—the finest extra **SPEAKER** for any set

WHITELEY ELECTRICAL RADIO CO. LTD., MANSFIELD, NOTTS.

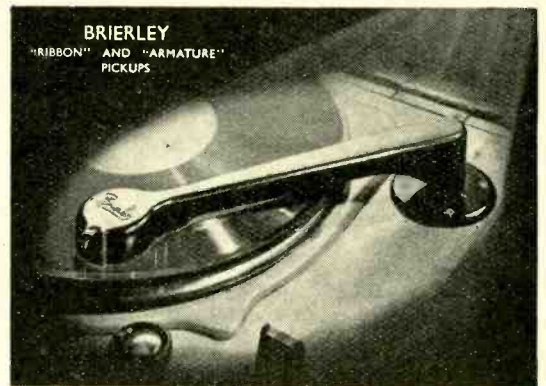

RIBBON TYPE

Fixed point pressure of $\frac{1}{2}$ oz.
Output Voltage 10 to 15 mV.
Price in U.K. including special
Mumetal screened transformer
and Purchase Tax. £10 2s. 4d.

ARMATURE TYPE

Fixed point pressure of $\frac{1}{2}$ oz.
Output voltage, $\frac{1}{2}$ to 1v.
Price in U.K. including special
Mumetal screened transformer
and Purchase Tax. £8 15s. 9d.

The Ribbon Pickup now being produced has a new *unbreakable ribbon*. Whilst the mass has been reduced, the effective damping has been increased without increasing the point stiffness. This feature in conjunction with a modified magnetic circuit has resulted in an increased output and an audibly better response at high frequencies putting this pickup even further ahead of any type hitherto available.

The design of these Pickups is such that any developments resulting from our continuous efforts to improve the quality of reproduction from gramophone records may readily be incorporated in existing models. Write for full details.

Demonstrations of Ribbon and Armature Pickups in conjunction with our standard Pre-amplifier and Low-Pass Filters: London, Webbs' Radio, Soho St., W.1.; Manchester, Holiday & Hemmerdinger Ltd., Hardman St.

Arrangements can be made for the loan of equipment to Radio and Gramophone Societies wishing to give special demonstrations of the High Fidelity Reproduction of Gramophone Records.

J. H. BRIERLEY (Gramophones & Recordings) LTD.,
46 Tithebarn Street, LIVERPOOL, 2.



Announcing ... SIX ENTIRELY NEW

ELECTRONIC INSTRUMENTS

by CINEMA-TELEVISION LIMITED

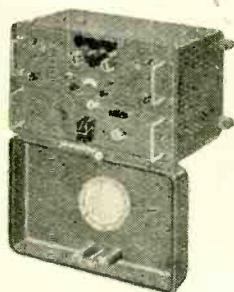

INDUSTRIAL ELECTRONIC METAL DETECTOR

An automatic inspection equipment for the detection of ferrous and non-ferrous metal particles of all kinds in non-metallic substances such as foodstuffs, plastics, textiles, tobacco, timber, pharmaceutical products, etc.

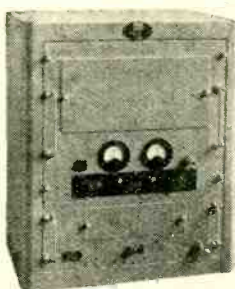

STANDARD ELECTRONIC COUNTER

A high speed electronic counter of particular appeal to the industrialist. Facilities are provided for batching, selective counting etc., the maximum counting-speed for the equipment being 30,000 per minute.

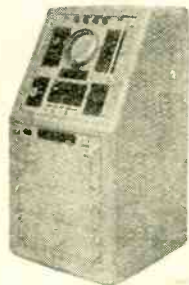

UNIVERSAL OSCILLOSCOPE

A unique instrument meeting fully the requirements of the serious users of oscilloscopes for laboratory and industrial purposes, arranged to permit readily the assembly of suitable units to fulfil every application. Complete range of units is available, e.g. stabilised time base, A.C. and D.C. amplifiers, 5 beam switch-unit etc.

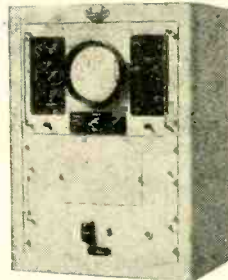

LABORATORY OSCILLOSCOPE

A high grade 6" screen oscilloscope expressly designed for laboratory use, incorporating hard valve linear time base, 3 megacycle "Y" amplifier and 1 megacycle "X" amplifier. Cupboard and trolley are available if required.

DEMONSTRATION OSCILLOSCOPE

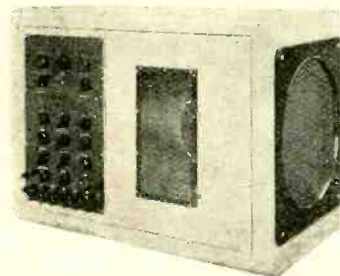

FOR LECTURE PURPOSES

Demonstrator and student alike will acclaim the features of this equipment — 15" tube with glare removing filter, 2 beam switch for simultaneous delineation of two recurrent wave forms, or their "addition" to produce a single resultant trace. Provision is made for setting up from rear of instrument.

PROCESS TIMER



A compact instrument, from the "CINTEL" range, providing simple and accurate electrical control for scientific and industrial processes of every kind. The timing range extends from 0.25 to 90 seconds.



CINEMA-TELEVISION LTD.,
INCORPORATING BAIRD TELEVISION LIMITED
WORSLEY BRIDGE RD., LONDON, S.E.26

Telephone: HITHer Green 4600

Suppliers to ADMIRALTY, MINISTRY OF AIRCRAFT PRODUCTION, MINISTRY OF SUPPLY, ARMAMENT RESEARCH, etc. Manufacturers of Scientific Instruments and Photo-electric cells.

*It's,
Unique*

THE NEW THREE-IN-ONE
PORTABLE RECEIVER TESTER
-means no more half-measures!

The Portable Receiver Tester, one of the new Marconi "Measurtest" Instruments, is an outstanding achievement. It provides the radio engineer with a highly efficient, portable unit which is, in effect, a combination of three instruments!

In one compact assembly, the Receiver Tester combines a crystal-standardised signal generator, a tone source and an audio frequency power meter—complete facilities in fact for overall measurements on radio receivers and tests on audio amplifiers. Available either for mains or battery operation, the instrument creates new standards of convenience, versatility and performance in radio test gear—a whole range of equipment for the price of one! And like all Marconi products, the Portable Receiver Tester is fully guaranteed. *A demonstration can be arranged, or full particulars supplied.*



HIRE PURCHASE TERMS AVAILABLE

MARCONI  INSTRUMENTS LTD.

ST. ALBANS, HERTS. Telephone: St. Albans 6161/5 • Northern Office: 30 ALBION STREET, HULL. Hull 16144
Western Office: 10 PORTVIEW ROAD, AVONMOUTH. Avonmouth 438 • Southern Office: 109 EATON SQUARE, S.W.I. Sloane 8615

Wharfedale

**Public Address
LOUDSPEAKER**

W. 12



Die Cast Non-resonant Chassis with accurate rear suspension. Impedance, 15 ohms. Diameter, 12". Weight 11½ lb. Peak Input, 15 watts.

13,000 LINES FLUX DENSITY

Price 135/-

Made and Guaranteed by

**WHARFEDALE WIRELESS
WORKS**

BRADFORD ROAD, IDLE, BRADFORD.

Telephone: Idle 461

Telegrams: Wharfdel, Idle, Bradford

*You
get
years of
faultless
service
from...*

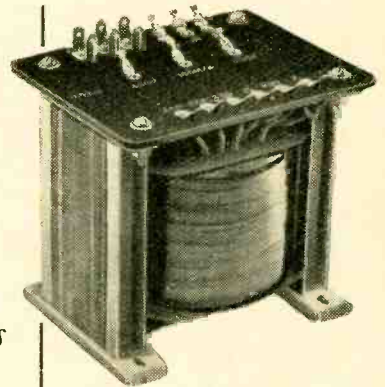

because they are —
INDIVIDUALLY DESIGNED
RIGOROUSLY TESTED
MECHANICALLY SOUND
ELECTRICALLY PERFECT



**"PURPOSE-BUILT"
Savage
TRANSFORMERS LTD.**

51, NORTHGATE STREET, DEVIZES. Phone 536

12113A

LONDON CENTRAL RADIO STORES

PHOTO ELECTRIC CELLS

Small infra-red image, glass converter tube.
Type C.V. 143. 50—100 v. Suitable for all purposes.

Price **21/-** each.

Kindly note : We cannot enter into correspondence regarding these Cells.



CHARGING BOARDS Control Panels Only as illustrated

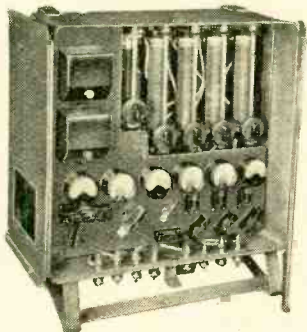

24 v., 1,260 watts. Includes five 1 in. moving coil ammeters (1, 0-40 a., 4, 0-15 a.). One moving coil voltmeter 0-40 v. Five heavy duty sliding resistances, etc., complete in metal case as shown with fold-back doors. Size, 18 x 17 x 8 1/2 ins. Offered at less than half the component value. **£4.19.6**
Price, carr. extra

Super Quality Heavy Duty TWIN-ELEMENT SLIDING RESISTANCES

5.4 ohm at 20 amp. 47 6
12 ohm at 10 amp. 39 6
70 ohm at 5 amp. 35 -

Type R1147A 7-VALVE U.H.F. RECEIVER Range approx. 200 megacycles (with 4 Acorn valves)

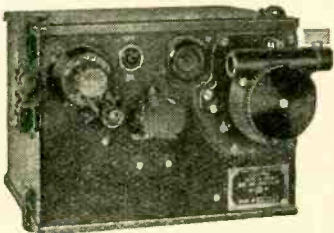

A Real Opportunity!

Beautifully constructed and fitted with micro-condenser drive. Valve types: two EF50, one EHC33, three 9B4, one 9B5. In black metal case, 8 x 7 x 6 in. Set complete with valves. Carr. paid **£2.7.6**

10-VALVE COMMUNICATION RECEIVER—Type R1155

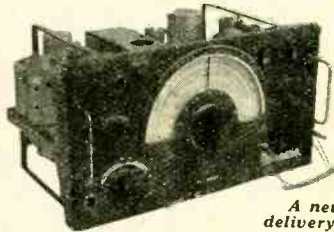

A new delivery!

These sets are as new. Need only a power pack for immediate use (see "W.W." July, 1946). Freq. range 7.5 mc/s-75 kc/s in five wavebands. Complete with 10 valves including magic eye. Enclosed in metal case. Every receiver is serial tested. **£12.10.0**
Set only
Complete with Power Pack and Loudspeaker, **£20**
for A.C. mains 200-250 v.
(Carr. and pkg. 10/6 extra.)

SMALL D.C. MOTORS. Ex-W.D.

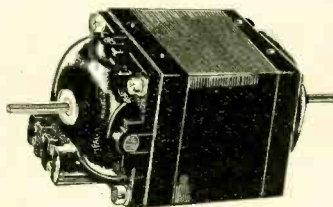

Will work on 12-24 v. Consumes .25 a. at 12 v. 3/16 in. spindle protrudes 1 in. both ends. Size of motor 2 x 2 x 3 1/2 in. Boxed, as new, each **25/-**

Ex-GOVT. TELEPHONE HANDSETS

Self-Energising. Needs no battery or current. Less Wall bracket. Each **15/-**

FRACTIONAL H.P. A.C. MOTORS Converted from ex-Govt. Generators

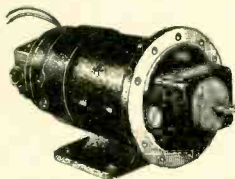

Brush type 220-250 v. 50 cycles approx. 5,000 r.p.m. Overall diam. 10 x 4 in. 1 in. spindle extends 1 in. both ends. Post 2/6 extra. **37/6**

SPECIAL OFFER 2-VOLT POWER PACKS Complete with Vibrator

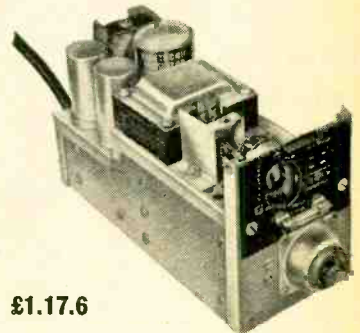

£1.17.6

Output approx 200 v., 60 ma. Size 9 x 5 x 3 in. A first-class job!

VIBRATORS 2-v. input. Self-rectifying type. 7/6 Output approx. 200 v., 60 ma.

RADAR VIEWING UNITS

Consisting of 6 in. diameter Electrostatic C.R. Tube, 7 valves including four EF50, potentiometers, resistances and other associated components. In metal cabinet 10 x 8 x 7 1/2 in. **£3.7.6**
Bargain price (plus carr. and pkg. 7/6.)

Type Demolition Mk. 1. EX-ARMY TEST SET—NEW



For circuit continuity and general testing. **£3.10.0**
In hardwood carrying case. Carriage paid

Please Note : All carriage charges relate to the British Isles only • We do not issue lists or catalogues

LONDON CENTRAL RADIO STORES, 23, LISLE ST. (GERrard 2969) LONDON, W.C.2

Closed Thursday 1 p.m. Open all day Saturday and weekdays 9 a.m.—6 p.m.



DRY ELECTROLYTICS

SINGLE, DUAL and TRIPLE CAPACITORS
in the now famous
"MICROPACK"
and
"LECTROPACK"
All-aluminium
constructions



| "MICROPACK" AND "LECTROPACK" SINGLE SECTION CAPACITORS | | | | | | | | | | | |
|--|-----------------|----------------|-------|----------|-------------------|-------------------|-----------------|----------------|-------|----------|-------------------|
| Capacitance Mfds. | Peak Wkg. Volts | Dim'n's Inches | | Type No. | Retail Price Each | Capacitance Mfds. | Peak Wkg. Volts | Dim'n's Inches | | Type No. | Retail Price Each |
| | | L | D | | | | | L | D | | |
| 50 | 12 | 1 1/2 | 1 1/2 | CE32B | 2/9 | 8 | 200 | 1 1/2 | 1 1/2 | CE18G | 3/3 |
| 1000 | 12 | 2 1/2 | 1 1/2 | CE10B | 8/6 | 16 | 200 | 2 1/2 | 1 1/2 | CE24G | 4/- |
| 2000 | 12 | 2 1/2 | 1 1/2 | CE23B | 12/- | 24 | 200 | 2 1/2 | 1 1/2 | CE25G | 4/6 |
| | | | | | | 32 | 200 | 2 1/2 | 1 1/2 | CE26G | 5/6 |
| 25 | 25 | 1 1/2 | 1 1/2 | CE32C | 2/9 | | | | | | |
| 50 | 25 | 1 1/2 | 1 1/2 | CE18C | 3/- | 2 | 350 | 1 1/2 | 1 1/2 | CE17L | 3/- |
| 500 | 25 | 2 1/2 | 1 1/2 | CE10C | 8/6 | 4 | 350 | 2 1/2 | 1 1/2 | CE18L | 3/3 |
| 1000 | 25 | 2 1/2 | 1 1/2 | CE23C | 12/- | 8 | 350 | 2 1/2 | 1 1/2 | CE11L | 3/9 |
| | | | | | | 16 | 350 | 2 1/2 | 1 1/2 | CE26L | 4/9 |
| 12 | 50 | 1 1/2 | 1 1/2 | CE32D | 2/9 | 30 | 350 | 2 1/2 | 1 1/2 | CE29L | 6/6 |
| 25 | 50 | 1 1/2 | 1 1/2 | CE18D | 3/- | 40 | 350 | 2 1/2 | 1 1/2 | CE10L | 7/6 |
| 50 | 50 | 1 1/2 | 1 1/2 | CE24D | 4/- | | | | | | |
| 100 | 50 | 2 1/2 | 1 1/2 | CE26D | 5/6 | 1 | 450 | 2 1/2 | 1 1/2 | CE32P | 2/9 |
| 250 | 50 | 2 1/2 | 1 1/2 | CE10D | 8/6 | 2 | 450 | 2 1/2 | 1 1/2 | CE18P | 3/3 |
| 500 | 50 | 2 1/2 | 1 1/2 | CE23D | 12/- | 4 | 450 | 2 1/2 | 1 1/2 | CE11P | 3/9 |
| | | | | | | 8 | 450 | 2 1/2 | 1 1/2 | CE19P | 4/6 |
| 250 | 100 | 2 1/2 | 1 1/2 | CE23E | 12/- | 16 | 450 | 2 1/2 | 1 1/2 | CE29P | 6/- |
| | | | | | | 24 | 450 | 2 1/2 | 1 1/2 | CE10P | 7/6 |
| | | | | | | 32 | 450 | 2 1/2 | 1 1/2 | CE37P | 10/- |
| 8 | 150 | 1 1/2 | 1 1/2 | CE18F | 3/- | | | | | | |
| 16 | 150 | 2 1/2 | 1 1/2 | CE11F | 3/3 | | | | | | |
| 32 | 150 | 2 1/2 | 1 1/2 | CE19F | 4/6 | | | | | | |
| 2 | 200 | 1 1/2 | 1 1/2 | CE31G | 2/9 | 4 | 500 | 2 1/2 | 1 1/2 | CE13P | 4/9 |
| 4 | 200 | 1 1/2 | 1 1/2 | CE32G | 3/- | 8 | 500 | 2 1/2 | 1 1/2 | CE10P | 6/6 |
| | | | | | | 16 | 500 | 2 1/2 | 1 1/2 | CE14P | 9/6 |

| "LECTROPACK" DUAL SECTION CAPACITORS | | | | | | | | | | | |
|--------------------------------------|-----------------|----------------|-------|----------|-------------------|-------------------|-----------------|----------------|-------|----------|-------------------|
| Capacitance Mfds. | Peak Wkg. Volts | Dim'n's Inches | | Type No. | Retail Price Each | Capacitance Mfds. | Peak Wkg. Volts | Dim'n's Inches | | Type No. | Retail Price Each |
| | | L | D | | | | | L | D | | |
| 16-16 | 150 | 2 1/2 | 1 1/2 | CE34F | 6/- | *16-16 | 350 | 2 1/2 | 1 1/2 | CE34L | 8/6 |
| 20-20 | 150 | 2 1/2 | 1 1/2 | CE35F | 6/6 | 24-8 | 350 | 2 1/2 | 1 1/2 | CE28L | 8/6 |
| *32-24 | 150 | 2 1/2 | 1 1/2 | CE34F | 7/6 | 24-16 | 350 | 2 1/2 | 1 1/2 | CE28L | 9/- |
| *50-30 | 150 | 2 1/2 | 1 1/2 | CE35F | 8/6 | 30-30 | 350 | 4 1/2 | 1 1/2 | CE37L | 12/- |
| | | | | | | 32-16 | 350 | 4 1/2 | 1 1/2 | CE37L | 11/- |
| 16-16 | 275 | 2 1/2 | 1 1/2 | CE27H | 7/- | | | | | | |
| 25-25 | 275 | 2 1/2 | 1 1/2 | CE28H | 9/- | 4-4 | 450 | 2 1/2 | 1 1/2 | CE34P | 6/- |
| | | | | | | 8-8 | 450 | 2 1/2 | 1 1/2 | CE27P | 7/6 |
| 8-8 | 350 | 2 1/2 | 1 1/2 | CE35L | 6/- | 16-8 | 450 | 2 1/2 | 1 1/2 | CE28P | 9/- |
| 16-8 | 350 | 2 1/2 | 1 1/2 | CE27L | 7/6 | 16-16 | 450 | 4 1/2 | 1 1/2 | CE37P | 11/- |
| 16-16 | 350 | 2 1/2 | 1 1/2 | CE28L | 9/- | 24-16 | 450 | 4 1/2 | 1 1/2 | CE37P | 12/- |

* Etched Foil Construction.

| "LECTROPACK" TRIPLE SECTION CAPACITORS | | | | | | | | | | | |
|--|-----------------|----------------|-------|----------|-------------------|-------------------|-----------------|----------------|-------|----------|-------------------|
| Capacitance Mfds. | Peak Wkg. Volts | Dim'n's Inches | | Type No. | Retail Price Each | Capacitance Mfds. | Peak Wkg. Volts | Dim'n's Inches | | Type No. | Retail Price Each |
| | | L | D | | | | | L | D | | |
| 30-10-10 | 350 | 4 1/2 | 1 1/2 | CE39L | 12/6 | 8-8-8 | 450 | 3 1/2 | 1 1/2 | CE38P | 11/- |
| 8-4-4 | 450 | 2 1/2 | 1 1/2 | CE10P | 10/- | 16-8-8 | 450 | 4 1/2 | 1 1/2 | CE39P | 12/6 |

LEADERSHIP. T.C.C. "MICROPACK" and "LECTROPACK" electrolytics have established themselves among discriminating dealers and service engineers as first choice for all condenser replacement purposes.

RELIABILITY. Hermetic sealing, "ALL-ALUMINIUM" construction and conservative rating ensure reliability of performance.

RANGE. The above tables show only an abridged

version of the extensive ranges featured in List No. 123 (available on request). There are T.C.C. replacements available for all purposes from American midgets to television receivers or public-address equipment.

DELIVERIES. Increasing bulk supplies go out to our recognised factors each week. In their own interests dealers should place firm orders with their wholesalers.

THE TELEGRAPH CONDENSER CO., LTD.

RADIO DIVISION

NORTH ACTON · LONDON · W·3

Telephone, ACORN 0061

Here's two types you rarely see so **BRIMARIZE** with a 2A3

TYPE 45 is a 2.5 volt triode and type 47 a pentode, both of which are still encountered in the output stages of early American receivers.

The triode type 2A3 will replace the 45 directly and with minor circuit changes the 47 also. Substitution of the 47 will result in loss of sensitivity and the power output will fall unless the output transformer is changed or its turns ratio reduced to match the new optimum load.

Because of the higher filament current of the 2A3 the valve must make good contact in its socket and the leads to the mains transformer must be of heavy gauge wire.

PUNCH HOLES HERE

| | | CHARACTERISTICS | | | |
|--|--|------------------|-------|------|-----------|
| | | 47 | 45 | 2A3 | |
| | | Filament Voltage | 2.5 | 2.5 | 2.5 volts |
| | | Filament Current | 1.75 | 1.5 | 2.5 amp. |
| | | Anode Voltage | 250 | 250 | 250 volts |
| | | Anode Current | 31 | 34 | 33 mA. |
| | | Grid Bias | -16.5 | -50 | -50 volts |
| | | Bias Resistor | 450 | 1500 | 1500 ohms |
| | | Optimum Load | 7000 | 3900 | 4000 ohms |
| | | Power Output | 2.7 | 1.6 | 2.0 watts |

| TYPE | CHANGE SOCKET | | CHANGE CONNECTIONS | | OTHER WORK NECESSARY | PERFORMANCE CHANGE |
|------|---------------|------------|-------------------------------|---|---|-----------------------------------|
| | FROM | TO | FROM OLD SOCKET | TO NEW SOCKET | | |
| 45 | U.X. 4 PIN | NO CHANGE | NO CHANGE | | NONE | NEGLECTIBLE |
| 47 | U.X. 5 PIN | U.X. 4 PIN | Pin No. 1 2 3 4 5 | Pin No. 1 2 3 Disconnect. Pin No. 4 | Change Bias Resistor to 1500 ohms 2 watt and Bias condenser to 25u F. 50 volts working. If fixed bias is employed it must be adjusted to give an anode current of approx. 35 mA. See note. | Reduced Sensitivity. See note. |

Note: For maximum power the output transformer turns ratio must be reduced to $\frac{2}{3}$ of its previous value.

BRIMARIZING . . . A scheme devised by BRIMAR for keeping repair lines on the move, a means whereby radio sets may be kept working happily in the home and not waiting on the shelf.

BRIMAR

RADIO VALVES

STANDARD TELEPHONES AND CABLES LIMITED, FOOTSCRAY, SIDCUP, KENT.

A SERVICE PLAN FOR PLANNED SERVICE

INSTRUCTIONS: Punch holes where indicated, cut away this portion and file for a quick reference guide.

12

45
47

PREMIER RADIO COMPANY

MORRIS & CO. (RADIO) LTD.

ALL POST ORDERS to 167 LOWER CLAPTON RD., LONDON, E.5. 'Phone: Amherst 4723.

ALL CALLERS to 169 FLEET STREET, LONDON, E.C.4. 'Phone: Central 2833.

Terms of Business: Cash with order or C.O.D. over £1.

Send 2½d. stamp for latest list.

GOVERNMENT SURPLUS

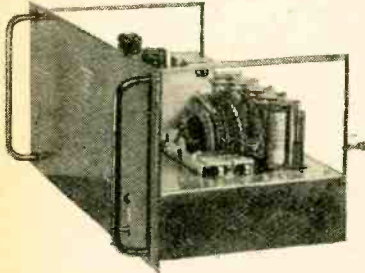

RELAY UNIT TYPE 9 consists of a 24 v. operated relay unit incorporating 3 KT38C valves, a telephone line (Un-selector) switch with 6 poles, 26 contacts, 5 P.O. type relays, 2 high-speed relays, and a quantity of other material. Contained in an attractive relay rack type metal case 19 x 19 x 9½ in. deep. Price £4/5/-, or without valves, 30/-. Carriage and packing 5/.

TEST UNIT AP53874 consists of a Test Unit for a U.H.F. Tx., incorporates a 230 v. 50 cfs Power Pack, with a smoothed output of 240 v. up to 60 mA and 6.3 v. 2 a., 2 EF50, 1 EC52, 1 EA60, 1 6Z4G, 1 Y63 Magic Eye, and a large quantity of condensers, resistors, and tuning gear. Contained in an attractive steel case. Size 10½ x 9 x 8½ in. Price 45/-. Carriage and packing 5/.

METAL RECTIFIERS.

Output 300 v. 60 ma., 5-; 275 v. 30 ma., 4/6; 250 v. 30 ma., 4-; 4 v. 1 a., 5-; 36 v. 75 ma., 1/6; 16 v. 1 a., 12/6; 48 v. 1 a., 25-; 16 v. 4 a., 30/-; 16 v. 8 a., 37/6; 30 v. 5 a., 37/6.

SIGNAL GENERATOR TYPE 33. Consists of a battery-driven generator with two separate units for approximately 1 metre and 7 metre operation, include 2 CV6 (VR136) horned triodes and one EA50 diode, also a large quantity of U.H.F. tuning gear. Contained in a teak case, size 18in. x 8in. x 8in. Price 30/-.

OUTPUT TESTER TYPE 8 consists of a unit incorporating three separate diode detectors and a 3-valve Amplifier, each diode with its separate U.H.F. Tuning System. A retractable 18in. aerial is fitted and three VR130 (HL23) valves, 3 D.I. Diodes and a large quantity of U.H.F. Tuning Gear is included. Contained in a teak case size 18 x 8 x 8in. Price 30/-, or minus three HL23 valves, 15/-.

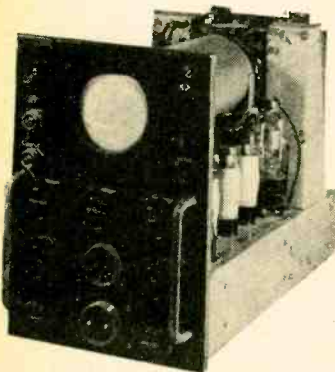

TEST UNIT TYPE 73 consists of a special purpose Oscilloscope that requires only rewiring and the addition of a few condensers and resistors to convert into a standard Oscilloscope. Input 230 v. 50 c. A 3½ in. C.R. tube and 1 812920A, 1 EB34, 1 5Z4, 3 8P41, 2 EA50, are included. Controls are "Brightness," "Velocity," "X Shift," "Y Shift," Focus Amplifier, "in, out," "Calibrate," "on, off/TX." Price £8 8/- Carriage and packing, 20/-.

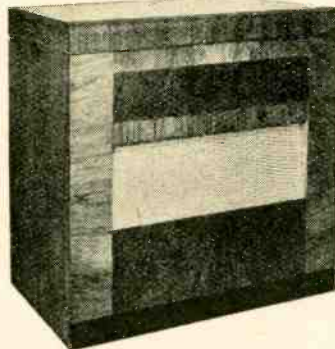

RADIOGRAM CABINETS. Dignified appearance and good workmanship. Size 31½ in. high, 18½ in. deep, 33in. wide. French polished, veneered walnut. Price £29. Also available complete with electric motor, auto stop and magnetic pick-up, £37 18/11. Ditto, with Rothermel Crystal Pick-up, £39 12 8. Or with 8 record-mixer changer, £49 10/8.

METERS. All meters are by the best makers and are contained in bakelite cases. Prices are about one-quarter the original cost.

| Range | Ext. | Fitting | Type | Price |
|----------|-------|---------|---------------|-------|
| 500 ma. | 3in. | Prof. | M.C.D.C. | 12/6 |
| 40 v. | 2in. | Flush | M.C.D.C. | 7/6 |
| 24 a. | 2in. | Flush | Thermo H.F. | 7/6 |
| 4 a. | 2in. | Port | H.W.H.P. | 3/6 |
| 20 a. | 2in. | Flush | M.C.D.C. | 7/6 |
| 40 a. | 2in. | Flush | M.C.D.C. | 7/6 |
| 25 a. | 3in. | Flush | M.C.D.C. | 7/6 |
| 25 a. | 3in. | Flush | M.C.D.C. | 7/6 |
| 25 a. | 3in. | Flush | M.I.D.C. | 7/6 |
| 500 µa. | 2½in. | Flush | M.C.D.C. | 7/6 |
| 5 ma. | 2½in. | Flush | M.C.D.C. | 10/- |
| 1 ma. | 3½in. | Flush | M.C.D.C. | 20/- |
| 500 µa. | 4½in. | Flush | M.C.D.C. | 25/- |
| 20 v. | 2½in. | Flush | M.C.D.C. | 7/6 |
| 15 v. | 3½in. | Flush | M.I.A.C.P.C. | 12/6 |
| 150 ma. | 2½in. | Flush | M.C.D.C. | 7/6 |
| 200 ma. | 3½in. | Flush | M.C.D.C. | 12/6 |
| 5,000 v. | 4½in. | Flush | Electrostatic | 6/- |

FERRANTI 1 MILLIAMPER METERS. 3½ in. external diameter, flush mounting, with self-contained Westinghouse bridge rectifier. Scale marked 0-10 volts with fifty divisions, fitted in well-made wooden box 6 x 5 x 3in., 35/-.

ALUMINIUM CHASSIS. Substantially made of bright aluminium, with four sides.

| | | | |
|----------------|------|-----------------|------|
| 7 x 3½ x 2in. | 4/6 | 9½ x 4½ x 2in. | 5/6 |
| 10 x 8 x 2½in. | 7/- | 12 x 9 x 2½in. | 7/6 |
| 14 x 9 x 2½in. | 8/3 | 16 x 8 x 2½in. | 8/6 |
| 20 x 8 x 2½in. | 10/6 | 22 x 10 x 2½in. | 13/6 |

SUPERHET TUNING PACKS. Completely wired and aligned. 13-40, 40-120, 150-570 metres. R.F. stage, 465 kc.; 9 connections only. Complete with 3-gang condenser, calibrated, engraved Perspex dial, and 8/M drive. Litz wound polystyrene insulation, permeability tuned I.P.'s, 7 kc. bandwidth. Price complete £3 17/6.

8 WATT A.C. AMPLIFIER. For 200-250 v. 50 c. mains. 2 to 16 ohms output. Mike, Gram, and Radio switched inputs. 2 8P41, one HI41, 2 Pen45, one UU5. Screened Input Mike Transformer. Tone Control. In attractive metal case. With Rola G.12 P.M. Speaker. £15 15/-.

LOUDSPEAKERS. 5in. P.M., 15-, with trans., 20-, 6in. P.M., 17/6, with trans., 22/6. 8in. P.M., 20-, with trans., 25/-; 10in. P.M., 15 Ω 6 watt, 47/6; 12in. P.M., 15 Ω 12 watt, £5. 12in. P.M., 15 Ω 12 watt twin-coil high fidelity, £8 8/-; 12in. P.M., 20 watt, £7. 6in., 1.140 Ω Field with trans., 27/6. 10in., 2,100 Ω Field 3 Ω 6 watt, 30/-.

ELECTRIC GRAMOPHONE MOTORS. A few available. Write for details.

OSCILLOGRAPH FOUNDATION KITS. Comprises a transformer giving an output of 800 v., condensers, metal rectifiers, 3½ in. Cathode Ray Tube and Base, and L.T. Transformer. 55/-.

GOVERNMENT SURPLUS

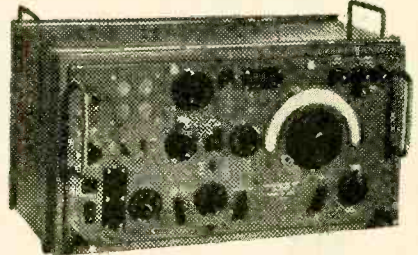

R107. ONE OF THE ARMY'S FINEST COMMUNICATIONS RECEIVER. (See "W.W.," Aug., 1945.) 9 Valves, R.F. amp. osc. Frequency Changer, 2 I.F.'s. (465 kc.). 2nd Detector, AVC. Af. amp. AC mains, 100-260 v. or 12 v. accum. Frequency range 17.5 to 7 m/cs., 7.25 m/cs. to 2.9 m/cs., 30 to 1.2 m/cs. Monitor L.S. built in. Complete. Write for full details. £16/16/- complete.

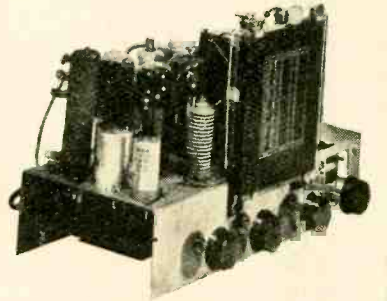

ALL-WAVE SUPERHET KIT. A Kit of Parts to build a 6-valve (plus rectifier) receiver, covering 16-50 metres. Medium and Long-wave bands. Valve line-up 8K7, 6K7, 6B7, two 25A6 in pushpull. Metal Rectifiers are incorporated for H.T. supply. Output impedance is for 3 and 15 ohms. The latest Wearite Coil Pack incorporating Iron Dust Coils is used, making construction and alignment extremely simple. A pick-up position on the wavechange switch and pick-up terminals is provided. A complete kit including valves but without speaker or cabinet. Chassis size 14 x 6in. Overall height, 9in. Price £11 16/3.

Suitable loudspeakers are the GOODMANS 10in. 6-watt P.M. at 47/6, or for superlative reproduction, the Goodmans 12in. P.M. at £6 15/-.



MIDGET RADIO KIT. Build your own midget radio. A complete set of parts, including valves, loudspeaker and instructions. In fact, everything except cabinet necessary to build 4-valve Medium and Long Wave T.R.F. radio operating on 200-250 v. mains, A.C. or D.C. Wavelengths covered 200-657 and 700-2,000. Size 10 x 6 x 6in. Completely drilled chassis. Price, including tax, £8 0/11.

SUPERHET MIDGET RADIO KIT. A complete kit of parts for a 5-valve superhet. Covers 16-50 and 200-557 metres, AC/DC 200-250 v. Size, 10 x 6 x 6in. Completely drilled chassis. Price including tax, £9. An attractive brown bakelite cabinet can be supplied for either kit at a cost of 27/3.

THE "BELLING-LEE PAGE"

Providing technical information, service and advice in relation to our products and the suppression of electrical interference

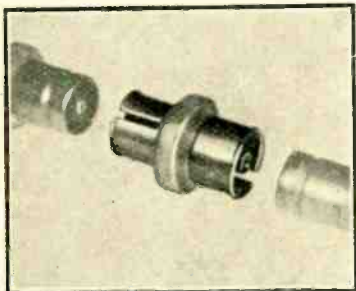

The new coaxial line connector L616 is shown here. It is interchangeable with the range and sells at 3/-

We are asked for a satisfactory method of joining lengths of co-axial cable, at best a tricky operation.

Our own installation department frequently require the same facilities, and we benefited by our war-time experience of supplying airborne dipoles and feeders which were installed in component parts of aircraft—fuselage, wing sections, etc., and at the point of assembly the co-axial feeders were plugged together. For our present-day requirements, when wiring a building, or for example an exhibition, we use two plugs L.604 at 1/6 each and one line connector L.616 at 3/-. If considering the matter of saving odd lengths of feeder at say 1/3 per yard, the cost is about equal for joining five yards, and anything over five yards shows a very considerable saving.

The Post Office Engineering Department responsible for investigating reported cases of interference are reluctant to take action unless the listener making the complaint has a reasonable aerial. A large number of complaints are ascribed to indifferent aerial arrangements, and in view of this known fact we are surprised that sets should be widely advertised as "requiring no aerial." The difference in quality of reception between a receiver using no aerial and one using just a "Winrod" window mounting aerial has to be experienced to be appreciated, and surely 19/6 is not too much to ask even for an aerial intended for use with a "second" receiver in the home. This price would be less than the cost of an alternative method of wiring for multi-point reception. It would, of course, not be an anti-interference aerial such as the "Skyrod" *1 and "Eliminoise" *2, but where interference is not too severe one can use a short length of screened feeder.

From Blackpool and Leigh we hear of dealers using with considerable satisfaction "Winrod" aeri-als with screened feeder to combat such interference. This is quite a logical development. Without doubt a "Winrod" window mounting aerial is more efficient than any indoor aerial. It is outdoors and it does stick out away from the building. Such an aerial is bound to give an improved signal to noise ratio, unless interference swamps the programme. There might still be interference picked up by the lead-in from the aerial to the set or picked up from the mains wiring in the house or building. By screening the lead-in with a few yards of low capacitance screened cable, this pick up of "not too severe" interference will be prevented. As a word of warning we would not recommend the use of a screened lead unless the "Winrod" was mounted not nearer the ground than a first-floor window sill. We cannot overstress the point that the length of this screened lead should not exceed five or six yards, and that a good quality co-axial be used such as L.600, or the losses will be greater than the gain. In a truly anti-interference aerial of good quality such as the "Eliminoise," transformers are introduced at the collector end of the cable, and again at the receiver, for the express purpose of matching the impedance of the aerial to the screened cable, and back to the input impedance of the receiver.

The "Eliminoise" can, of course, be used with a "Skyrod" erected well out of range of severe interference, and a long screened lead may be taken to the receiver without appreciable loss of signal.

So far as "Belling-Lee" is concerned we do not really mind whether we sell aeri-als or interference suppressors. But we would remind readers that a set lead suppressor L.300 sells at 59/6, whereas a "Winrod" aerial L.581 sells at 19/6. In many cases where a receiver is picking up a lot of interference, a "Winrod" is the most reasonable proposition for the listener.

R.C.M.F. EXHIBITION

We hope you will come and visit us at the above Exhibition to be held at the Grosvenor House Hotel, Park Lane, London, W.1, on March 2nd to 4th inclusive. Our Stand is No. 34. We shall be showing a comprehensive range of components and aeri-als, many of them available for the first time. These include

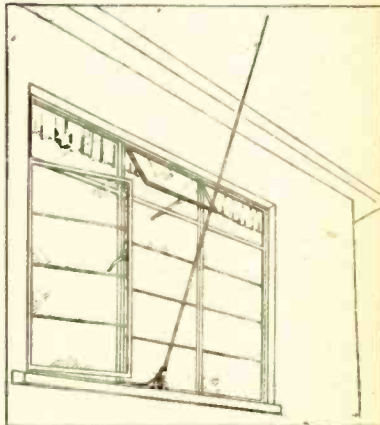

The illustration shows the "WINROD" window aerial L581. Price 19/6. (Note to dealers at foot of page)

the new B8A valveholder, our range of Television and car radio co-axial plugs and sockets with an outlet box for skirting board termination. A new two-pin reversible or non-reversible plug for use with our balanced twin feeder L.336. Our range of suppressors include a new design in car suppressors, which screw into the H.T. lead socket on the distributor, while the terminal carrying the lead from the coil screw into the head of the suppressor. An essential item for the prevention of interference with the Television and Electronic industry.

*1. "SKYROD" (regd. trade name) 18ft. collector in 3 sections with chimney lashings.

L.518 Collector only £4 4s.

L.618 Complete with "Eliminoise" equipment and screened feeder, £10.

*2. "ELIMINOISE" (regd. trade name) L.308k aerial and receiver transformers, 50ft. screened feeder, aerial and earth wire and insulators complete, £6 6s.

*3. Set lead suppressor, L.300/3. £2 19s. 6d.

Note to dealers:

"WINROD" AERIALS, ex-stock, from your wholesaler (supplied in cartons containing 6).

BELLING & LEE LTD
CAMBRIDGE ARTERIAL ROAD, ENFIELD, MIDDXX

ELIMINATE SOUND DISTORTION

Can distortion be eliminated? Not quite, of course, but it can be reduced to a minimum by the use of loudspeakers which will introduce as little discoloration as possible—well designed loudspeakers—Vitavox loudspeakers in fact.

VITAVOX

MANUFACTURERS OF SOUND EQUIPMENT

VITAVOX LIMITED

Westmorland Road, London, N.W.9, England
Grams: Vitavox, London, England



**CONSOLE
REPRODUCER MODEL KC10**

Designed for better listening in the home, the KC10 Console Reproducer incorporates the K12/10 12 in. moving coil loudspeaker in an acoustically damped, totally enclosed, cabinet of optimum dimensions. The walnut veneered cabinet is hand polished and fitted with an anodised aluminium grille. **PRICE 20 Gns.**

E.M.I. TRAINING

FOR CAREERS IN ELECTRONICS

E.M.I. basic training fits you for entry to Careers in such fields as:—

- SERVICE ENGINEERING
-
- OPERATING
-
- DESIGN AND DEVELOPMENT
-
- TECHNICAL SALESMANSHIP
-
- TEACHING



The Correspondence and College Courses provided by E.M.I. Institutes which cover recognised diplomas such as the City and Guilds, etc. are written and supervised by E.M.I.★ scientists who are specialists in Electronic Science.

Courses are already available in such subjects as Basic Radio, Basic Television, etc., and the prospectus is being constantly extended.

With this basic training you can eventually become a specialist in Television Radio Communications, Radar, Navigational Aids, Audio Frequency, Medical and various Electronic applications. There are also short courses for Executives, Amateurs, Students, etc.

For full details apply to your local "H.M.V." Radio dealer or direct to:—

The Principal: PROFESSOR H. F. TREWMAN, M.A. (Cantab), M.I.E.E., M.I.Mech.E., M.Brit.I.R.E.

E.M.I. INSTITUTES LTD
Dept. 16, 43, Grove Park Road, Chiswick, London, W.4

★ The E.M.I. Group includes "H.M.V.", Marconiophone and other important electronic interests

Virtually Distortionless

MODEL A.D./47 10-VALVE TRIODE CATHODE FOLLOWER AMPLIFIER

This is a 10-valve amplifier for recording and play-back purposes for which we claim an overall distortion of only 0.01 per cent., as measured on a distortion factor meter at middle frequencies for a 10-watt output. The internal noise and amplitude distortion are thus negligible and the response is flat plus or minus nothing from 50 to 20,000 c/s and a maximum of .5 db down at 20 c/s.

A triple-screened input transformer for 7½ to 15 ohms is provided and the amplifier is push-pull throughout, terminating in cathode-follower triodes with additional feedback. The input needed for 15 watts output is only 0.7 millivolt on microphone and 7 millivolts on gramophone. The output transformer can be switched from 15 ohms to 2,000 ohms, for recording purposes, the measured damping factor being 40 times in each case.

Built-in switched record compensation networks are provided for each listening level on the front panel, together with overload indicator switch, scratch compensation control and fuse. All inputs and outputs are at the rear of the chassis.



Send for full details of Amplifier type AD/47



C.P.20A. 15 WATT AMPLIFIER

for 12 volt battery and A.C. Mains operation. This improved version has switch change-over from A.C. to D.C. and "stand by" positions and only consumes 5½ amperes from 12 volt battery. Fitted mu-metal shielded microphone transformer for 15 ohm microphone, and provision for crystal or moving iron pick-up with tone control for bass and top and outputs for 7.5 and 15 ohms. Complete in steel case with valves.

As illustrated. Price £28 0 0

RECORD REPRODUCER

This is a development of the A.C.20 amplifier with special attention to low noise level, good response (30-18,000 cps.) and low harmonic distortion (1 per cent. at 10 watts). Suitable for any type of pick-up with switch for record compensation, double negative feedback circuit to minimise distortion generated by speaker. Has fitted plug to supply 6.3 v. 3 amp. L.T. and 300 v. 30 m/a H.T. to a mixer or feeder unit.



Complete in metal cabinet and extra microphone stage. As illustrated. Price 25½ Gns. CHASSIS, without extra microphone stage. Price £21

EXPORT

Enquiries from Overseas will receive prompt attention. CONTINENTAL BUYERS are invited to get into touch with our Belgian Agents:

Ms. Constant L. Bisman,
129 Avenue de la Reine,
Bruxelles

Téléph. 16.10.31.

Vortexion
LIMITED

257-261 THE BROADWAY, WIMBLEDON, LONDON, S.W.19

TELEPHONES: LIBerty 2814 and 6242-3.

TELEGRAMS: "VORTEXION, WIMBLE, LONDON."

THE PARMEKO

MERCURY
SERIES

Announcing this amazing
new range of Parmeko
Hermetically sealed
Transformers and Chokes.

Developed to operate
under abnormal
conditions.

PARMEKO OF LEICESTER
Makers of
Transformers.

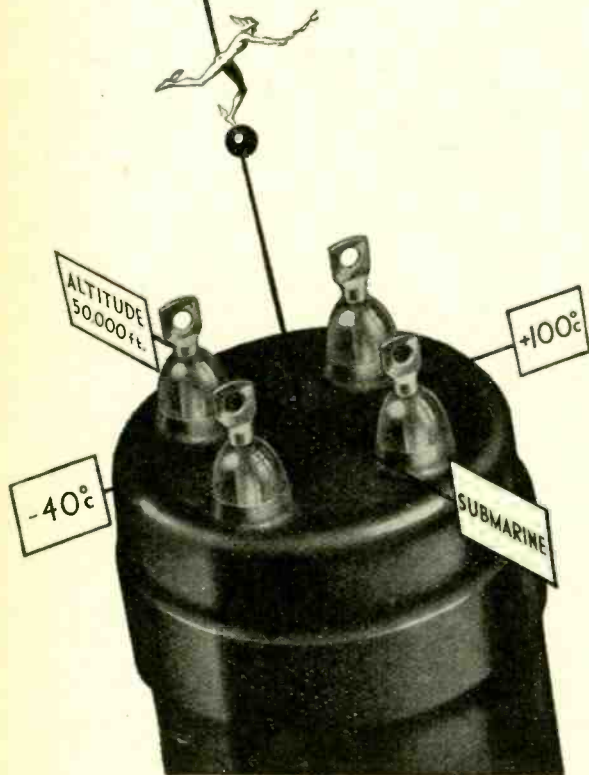

CONSISTENTLY
Accurate

Pullin Miniature Instruments are characterised by their robust construction, good damping, excellent finish and pleasing appearance. The square types enhance the appearance of rectangular switchpanels.

A complete series of square flush type instruments with styled covers is now available in 2", 2½" and 3½" dial sizes.

Complete range includes Moving Coil; Rectifier; Thermo-couple, for all sizes; and Moving Iron AC/DC types in the Series 35.

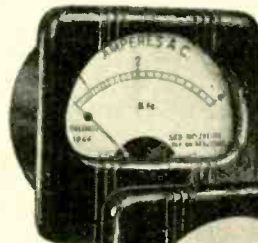

SERIES
20
2"
DIALS

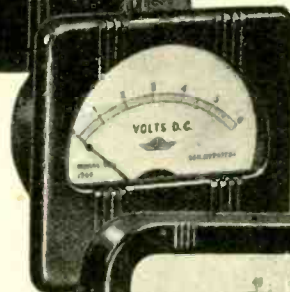

SERIES
25
2½"
DIALS

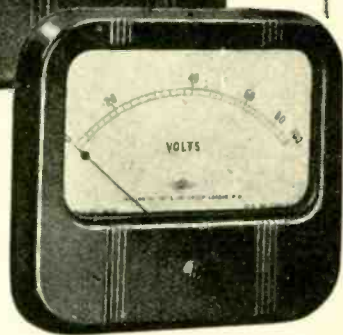

SERIES
35
3½"
DIALS

We can give early
delivery—write for
details.

PULLIN
MINIATURE
INSTRUMENTS



MEASURING INSTRUMENTS (PULLIN) LTD

Address all enquiries to Dept. J, Electric Works,
Winchester Street, Acton, London, W.3. Telephone: Acorn 4651-4

Choose a

MARCONIPHONE

— The REAL Thing!

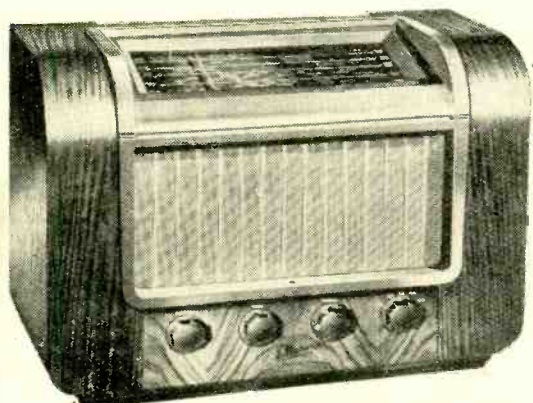

5-Valve, 5-Waveband AC Table Model T14A with Bandsread S.W. Tuning
 Just the instrument for every type of listener. It is a superb world radio giving first-class reception on five wavebands with outstanding short waveband performance. The tonal reproduction is of the highest quality; operation is simple and the cabinet of figured walnut with a moulded escutcheon is a pleasing combination.

Price 25 gns. (plus £8.10.8 purchase tax)

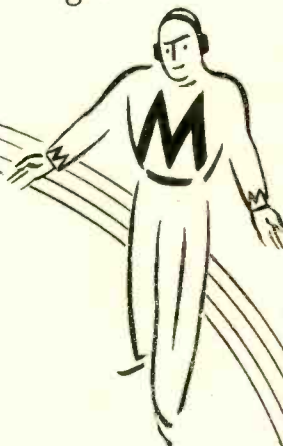

5 - Valve, 2 - Waveband " Companion " Receiver Model T15 DA

A transportable with inbuilt aerial — simply requires mains connection for immediate operation. This compact radio set, weighing only 7½ lb., has a cabinet of attractive modern design finished in cream with maroon controls and carrying handle.

Price 14½ gns. (plus £4.19.0 purchase tax)

SEE THE SIGNATURE

G. Marconi

ON EVERY SET

H. T. RECTIFIERS

for broadcast receivers

A range of rectifiers is now available which will meet **manufacturers'** general requirements for broadcast radio receivers. These units are very much smaller in bulk and weight, have a high efficiency and good regulation.

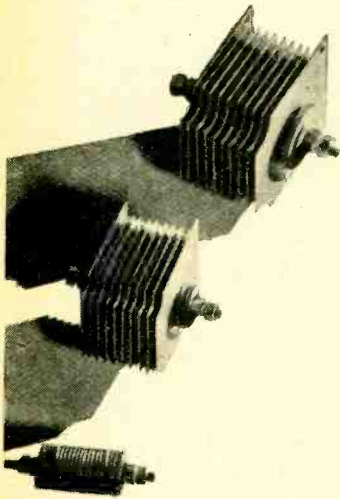

| Type | Output | | Max. input Volts | Overall dimensions | | |
|--------|--------|-----|---------------------|--------------------|-----------------|-----------------|
| | Volts | mA | | Length | Width | Height |
| 14A118 | 600 | 120 | 275 | 4 $\frac{1}{16}$ | 2 $\frac{1}{4}$ | 2 $\frac{1}{4}$ |
| 14A79 | 400 | 120 | 210 | 3 $\frac{1}{8}$ | 2 $\frac{1}{4}$ | 2 $\frac{1}{4}$ |
| 14A79 | 400 | 75 | 210 | 3 $\frac{1}{8}$ | 2 $\frac{1}{4}$ | 2 $\frac{1}{4}$ |
| 14A59 | 300 | 75 | 170 | 2 $\frac{3}{8}$ | 2 $\frac{1}{4}$ | 2 $\frac{1}{4}$ |
| 4A79* | 245 | 120 | 250 | 3 $\frac{1}{8}$ | 2 $\frac{1}{4}$ | 2 $\frac{1}{4}$ |
| 14A46* | 270 | 60 | 250 | 2 $\frac{3}{8}$ | 2 $\frac{1}{4}$ | 2 $\frac{1}{4}$ |
| 15B46* | 270 | 30 | 250 | 1 $\frac{1}{8}$ | 1 $\frac{1}{4}$ | 1 $\frac{1}{4}$ |
| 5D28† | 120 | 20 | 108 | 1 $\frac{9}{16}$ | $\frac{3}{8}$ | 25/32 |

* For AC/DC receivers.

† For battery eliminators.

These units are available to MANUFACTURERS ONLY and details may be obtained from Dept. W.W.3.

WESTINGHOUSE BRAKE & SIGNAL CO. LTD., 82 York Way, King's Cross, London, N.1.

WESTINGHOUSE
WESTALITE

METAL
RECTIFIERS

'co-axial construction . . .'

The acknowledgment of the many weaknesses in mechanical design and construction of loudspeakers of contemporary design was responsible for the origin of the Series "700" Reproducers. It was determined firstly to design a precision product, irrespective of apparent cost, and then, by the installation of special purpose machines and equipment, produce it at a cost comparable with our previous models. The basis of the design of the "700" Series is the co-relation of all component parts to the axis of the Reproducer, each fitting the one to the other to very close tolerances on diameters, by means of precision machining of all parts. Hence the term "co-axial" construction applied to this Series. The more important details of design and construction will be described and illustrated in subsequent issues.

Reproducers & Amplifiers Ltd., Frederick Street, Wolverhampton

R & A
REPRODUCERS

NEW ADDITIONS TO THE **EDDYSTONE** RANGE

The 'Eddystone' SEMI-AUTOMATIC MORSE KEY

This is a most outstanding production, totally enclosed in a streamlined diecast housing finished in fine ripple black with chrome relief. This key has a really beautiful movement (try it at your dealers) and is fully adjustable to enable the operator to make full use of the wide range of speeds provided. The handle has been designed to give equal facility to right or left handed operators. A short-circuiting switch is fitted to the base which is a heavy diecasting, provided with rubber feet and holes for screwing down. No. 689 £3.17.6



The 'Eddystone' VIBRATOR POWER UNIT

This unit has been designed to permit operation of the "640" receiver from a 6-volt accumulator—or any other equipment, the M.T. consumption of which is not more than 65 mA. It comprises a transformer, fuse, non-synchronous vibrator, rectifier valve (6X5G), on/off switch, pilot light and filters to prevent R.F. interference. Smoothing is not included—the choke and condensers fitted in receiver perform this function. Heavy cable for connection to battery and lead terminating in octal plug for fitting direct to socket on the "640" receiver. Enclosed in ripple finish black metal cabinet. Consumption from a 6-volt battery (with a "640" receiver) between 5 and 6 amperes.

No. 687

£7.17.6

ALSO AVAILABLE

No. 669 'S' Meter 5 Gns.
No. 690 Crystal Calibrator £12

No. 678 Modulation Indicator £8.15.0
No. 683 Beam Aerial Kit £19.10.0

If you do not know your local Eddystone Retailer we will send you his address. We do NOT supply direct.

STRATTON & Co. Ltd., EDDYSTONE WORKS, ALVECHURCH Rd., BIRMINGHAM, 31

The **LOWEST EVER**

attenuation & capacitance

CO-AX

air insulated articulated
CABLES for R.F.

TRANSRAD LTD. 138A ROMWELL ROAD. LONDON, S.W. 7

CO-AX

| LOW ATTEN. TYPES | IMPEDANCE OHMS | ATTEN. db/100ft. at 100 Mc/s | LOADING kW | OD |
|------------------|----------------|------------------------------|------------|-------|
| A1 | 74 | 1.7 | 0.11 | 0.36" |
| A34 | 73 | 0.6 | 1.5 | 0.85" |

| LOW CAPAC. TYPES | IMPEDANCE OHMS | CAPAC. mms/ft | BREAKDOWN Volt | OD |
|------------------|----------------|---------------|----------------|-------|
| C1 | 150 | 7.3 | 1100 | 0.36" |
| XPC1 | 132 | 10.2 | 950 | 0.36" |
| C11 | 173 | 6.3 | 800 | 0.36" |
| C22 | 184 | 5.5 | 900 | 0.44" |
| C33 | 220 | 4.8 | 1000 | 0.64" |
| C44 | 252 | 4.1 | 1150 | 1.03" |

† Bending radius 5"
★ Photocell cable.

Write for Characteristics of further types.

**AVAILABLE
NOW!**

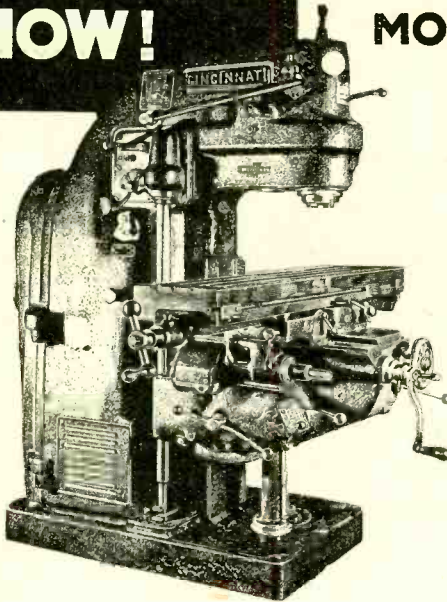

**MORE THAN THIRTY THOUSAND
MACHINE TOOLS**

Government Surplus machine tools of many different types are available for purchase, ready to help you in your drive for increased production. Additional machine tools frequently become available, so keep in touch with your nearest Disposal Centre.

DISPOSAL CENTRES, where records of all machines available may be inspected, are open to enquirers from 10 a.m. to 4 p.m. Monday to Friday inclusive:—

LONDON—Room 0088, Ground Floor, Thames House North, Millbank, S.W.1. BIRMINGHAM—C.M.L. Buildings, Great Charles Street. BRISTOL—8/9 Elmdale Road, Bristol 8. CARDIFF—Imperial Buildings, Mount Stuart Square. GLASGOW—21 Glassford Street. LEEDS—10 Bank Street, off Boar Lane. MANCHESTER—Britannia House, Fountain St.

ISSUED BY THE MINISTRY OF SUPPLY

The
MICOVAC
ELECTRONIC TESTMETER



- 22 Ranges
- Long-life batteries
- VHF probe and 5000v D.C. multiplier optional.



*The multi-range
meter that will measure
A.F. & R.F. signal voltages!*

PRICE £24. 10s.

ELECTRONIC INSTRUMENTS LTD
17 Paradise Road, Richmond, Surrey

**“You’re CERTAIN to get
it at ARTHURS!”**

★ **VALVES** : We have probably the largest stock of valves in the Country.

Let us know your requirements.

AVOMETERS. NOW IN STOCK.

| | |
|--------------------------------|----------|
| AVOMETER, Model 7 | £19 10 0 |
| AVOMETER, Model 40 | £17 10 0 |
| VALVE TESTER (Complete) | £16 10 0 |
| TEST BRIDGE | £11 0 0 |
| AVOMINOR, Universal Model | £8 10 0 |
| AVOMINOR, D.C. Model | £4 4 0 |
| SIGNAL GENERATORS, A.C. | £13 0 0 |

TAYLORS' METERS. COMPLETE RANGE NOW IN STOCK.

All orders sent by return of Post. **STAGE EQUIPMENT PROJECTOR LAMPS** Terms C.O.D. or cash with order.

London's Oldest Leading Radio Dealers.

Arthur's EST. 1919
PROPS: ARTHUR GRAY, LTD.

Our Only Address: **Gray House, 150, Charing Cross Rd., London, W.C.2** TEMple Bar 5833/4.
ELECTRICAL, TELEVISION & RADIO ENGINEERS.

RM Radio Feeder 483

Designed to supply radio signals to all classes of amplifiers. Three wave bands. Output 5 volts across 680K-ohms. Three valves 6K8G, 6K7G, 6Q7G. Price £12 12s. plus £4 1s. 10d. purchase tax.

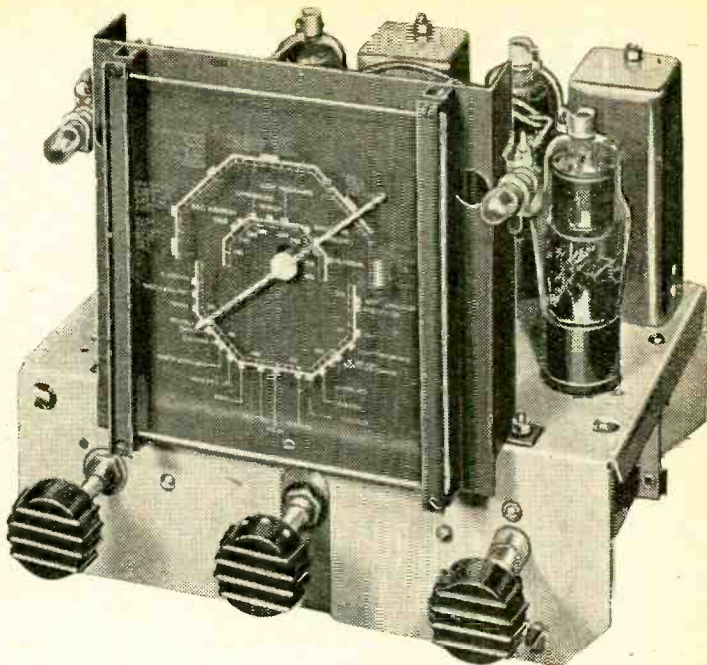

Send for full particulars.

R. M. ELECTRIC LTD., TEAM VALLEY, GATESHEAD, 11.

Simon

SOUND SERVICE

THE COMPLETE SERVICE FOR SOUND RECORDING AND REPRODUCTION

- ★ Mobile, static and specialised recording units.
- ★ Complete Wire Recorders, Recording and Wipe-off Units.
- ★ Recording Amplifiers.
- ★ Moving Coil and Crystal Microphones.
- ★ Sapphire cutting and reproducing stylii.
- ★ Blank recording discs from 5in. to 17in., Single or Double sided.
- ★ Lightweight, moving iron, permanent sapphire and moving coil pick-ups.
- ★ A comprehensive range of accessories to meet every requirement of the sound recording engineer.
- ★★ And our latest development (of special interest to users of sapphire and delicate pick-ups)—THE SIMTROL. This is a controlled micro-movement easily fitted for use with any type of pick-up.



Portable Dual Channel Recording and Replay Outfit.

OUR WELL-EQUIPPED WORKSHOPS ARE AVAILABLE FOR THE DEVELOPMENT OF EQUIPMENT TO MEET SPECIAL NEEDS.

SIMON SOUND SERVICE, Recorder House, 48/50, George St., Portman Square, London, W.1.

CABLES : Simsale, London.

TELEGRAMS : Simsale, Wesdo, London.

TELEPHONE : Welbeck 2371/2.

Small But Highly Efficient

33/-
RETAIL
PRICE

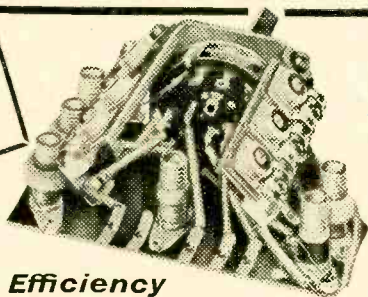

Maximum Efficiency
Minimum Size 3 1/2" x 2" x 1 1/2"

The "Q" pack is a certain signal booster. Will improve the sensitivity of any superhet, and its compactness greatly facilitates construction of midget receivers. Employs 6 high "Q" coils on polystyrene formers, with adjustable iron cores. One hole fixing and only 5 connections. Three models L.M.S., M.2.S., L.M. Trawler, Special terms to set makers and wholesalers.

Sole Manufacturers:

MORGAN OSBORNE & CO. LTD.
WARLINGHAM, SURREY. UPPER WARLINGHAM 2560



WELWYN carbon resistor

WELWYN ELECTRICAL LABORATORIES LTD.
Welwyn Garden City, Herts Telephone Welwyn Garden 78168

Resistors produced by the cracked carbon process remain stable to $\pm 1\%$ of initial value.

★ Tolerance $\pm 1\%$
 $\pm 2\%$ $\pm 5\%$

Low temperature co-efficient.

ELMSLEIGH RADIO CO.

offer the quality enthusiast the

Wireless World Quality Amplifier

as described by Mr. D. T. N. Williamson in the May 1947 issue. Built with first-grade components on chromium-plated chassis, PARTRIDGE Transformers and OSRAM Valves at

22 GNS.

We are pleased to construct feeder units for gramophone reproduction and radio tuners to customers' own specifications or to advise you on your problems.

THE ELMSLEIGH RADIO CO.

1102 LONDON ROAD, LEIGH-ON-SEA, ESSEX.

Telephone Leigh-on-sea 75168.



By Order of the Minister of Supply — Without Reserve

TAKELEY, Nr. BISHOP'S STORTFORD

5 Days' Sale

of

GOVERNMENT SURPLUS STORES & PLANT

at

M.O.S. DEPOT No. 263

including 1,000 Petrol Engines, Generating Sets of various types and makes. 1,500 Metal Bench Vices from 2 in. to 6 in. 220 Woodworkers' Vices — 100 Templet Plates. 300 Lots of Carpenters', Blacksmiths' and other tools. 500 Lots of Radio Equipment. Carpenters' and Metal Workers' Benches—Hydraulic Power Units on Trailers—Welding Plants—Steel Filing Cabinets and Chests. Aircraft Spares and numerous other lots.

Auctioneers:

G. E. SWORDER & SONS

SALE DAYS:

Monday, MARCH 1st to Friday, MARCH 5th, 1948

at 11 a.m. Daily.

VIEW DAYS—Monday, February 23rd to Friday, February 27th, 10 a.m. to 4 p.m.

CATALOGUES (6d. each, postal orders only) FROM THE AUCTIONEERS' OFFICES, BISHOP'S STORTFORD. Telephone 691 — 5 lines.

TELE RADIO (1943) LTD.

| | |
|---|---------|
| Miniature 2 Gang Condensers, .00038 mfd. with trimmers | 11 6 |
| Four Gang .0005 Condensers | 19 6 |
| Belling & Lee 5 Pin P. & S. | 4 5 |
| Belling & Lee 7 Pin P. & S. | 5 0 |
| Co-axial Cable 3/8 dia. 22ft. lengths with plug each end (Ex W.D.) | 5 0 |
| Mains Transformers Type T500/180EX. 500—0—500 180 mA. 4 v. at 4 a., 4 v. at 8 a., 4 vol.-2 a., 4 vol.-2 a. | £3 19 6 |
| TM. 600/180Ax. 600—500—400—400—500—600 at 250 mA. 5 volts at 3 amp. 6.3 volts at 5 amp. 6.3 volts at 3 amp. | £5 12 6 |

ALL ABOVE ITEMS ARE IN STOCK

177a Edgware Road, W.2. PADDINGTON 6116 & 6506.

Have you heard—

THE CONCERTO ? FOR YOUR PICK-UP AND SPEAKER

This is the Finest Record Producer available because—

1. Distortion is only 1 1/4% at 6 watts, 2% at 12 watts. (Independently Certified Figures)
2. Hum level is negligible.
3. It will take any type of pick-up—moving coil—moving iron—crystal.
4. Separate Bass and Treble Controls with a Double Bass Boost Circuit.
5. 12 months unconditional guarantee.
6. 9 Valve Circuit—8 Triodes plus Rectifier.

PRICE **£27/10/0**

The "Concerto"—the Amplifier that is making itself heard
CHARLES AMPLIFIERS LTD., 1E, Palace Gate, Kensington, London, W.8. (Phone: WESTern 3350)

RADIO-CRAFT LIBRARY

HANDY KINKS AND SHORT CUTS.

UNUSUAL PATENTED CIRCUITS 1944-1946.

RADIO QUESTIONS AND ANSWERS.

ADVANCED SERVICE TECHNIQUE.

AMPLIFIER BUILDER'S GUIDE.

RADIO-ELECTRONIC CIRCUITS.

AMATEUR RADIO BUILDER'S GUIDE.

RADIO TEST INSTRUMENTS.

ELEMENTARY RADIO SERVICING.

HOW TO BUILD RADIO RECEIVERS.

3/6 each. Plus 2d. postage.

We have the finest stock of British and American radio books. Complete list on application.

THE MODERN BOOK CO.

(Dept. W.2)

19-23, FRAED STREET, LONDON, W.2.

GOOD LINES FROM VALLANCE'S AVJ ALL-WAVE OSCILLATOR, for operation on 200 to 250 volts. DELIVERY FROM STOCK.

This Avj Oscillator is an inexpensive modulated oscillator having several improved features, making it suitable for test room or general laboratory use. It covers a continuous fundamental frequency band from 95mc. to 40mc. by means of six separate coils mounted on a rotary turret selector. Each band is directly calibrated in kc. on a large, clearly marked dial, calibration errors being not greater than 1% at any frequency. The variable condenser has a modified logarithmic law, thus giving sensibly constant percentage frequency discrimination over the whole scale.

RANGE 1H. 30mc-80mc. 4. 700kc-2200kc.
 1. 14mc-40mc. 5. 250kc-800kc.
 2. 5mc-15mc. 6. 95kc-300kc.
 3. 1800kc-6000kc.

PRICE £13. (Ratting Charge 3/6)

We can supply from stock the following:

TEST EQUIPMENT.

| | |
|---|----------|
| D.C. Avj Minor | £4 4 0 |
| Universal Avj Minor, 22 ranges | £8 10 0 |
| Taylor 120A Junior AC DC, 21 ranges | £7 10 0 |
| Taylor 90A 1,000 ohms/volt AC DC, 40 ranges | £15 15 0 |
| Walsall, Model 845, 2,000 ohms per volt, with low ohms range | £14 6 8 |
| Mullard Resistance and Capacity Bridge, 10 ohms to 10 megohms, and 10PF to 10mfd. | £15 15 0 |

B.P.L. SIGNAL GENERATOR. Frequency Range—100-250, 250-650, 650-1,600kc. 1.6-4.5, 4.5-12, and 12-30mc. Calibration accuracy. 1% internal modulation 400 C.P.S., 6 step multiplier and attenuator, A.C. Mains 200 to 250v., £16 10 0.

TAYLOR 65B SIGNAL GENERATOR. Frequency Range—100-300, 300-900, 900-2,700kc., 2.7-8, 8-23mc. Internal modulation is 30% max. at 400 C.P.S.

Coarse Attenuator has 5 positions. Output selector has three settings, viz. Mains Off—Int. Mod.—Ext. Mod. Max. audio output is about 1 volt. £15 10 0.

Avj Valve Tester. Has 12 different valve sockets on valve selector panel, combined with element selector switch. Ten positions on each switch. Controls on tester proper arc: Anode, Screen, Select Anode Heater, ma/v and set zero. Neon bulb indicates A.C. Mains. Large Scale Meter reads—'GOOD'—'INDIFFERENT'—'REPLACE.' Works on A.C. Mains 200-250 volts. Price £16 10 0.

All Taylor Instruments can be purchased on H.P. Terms. Particulars on request.

Speedy Postal Service C.W.O. or C.O.D.

VALLANCE & DAVIDSON, LTD.

144 BRIGGATE, LEEDS 1. Phone: 29429/9.

Staff call signs: G2HHV, G85X, G3ABD, G3AAV.

ONE used Pam amplifier, complete with two speakers, fitted with mod. meter, ideal for dance bands, halls, etc. for sale: £20, bargain! —Mayfield Electronics, Ltd., 7, Station Parade, Virginia Water, Surrey. [9293]

R1155 receiver, fully modified, d.f. components removed and mains transformer, rectifier and 6.F.6 output valve fitted, housed in polished oak table cabinet with 8in energized speaker, complete, ready to switch on: £20 or nearest offer secures.—Write Box 5077. [9119]

"WIRELESS WORLD" quality amplifier PX 4s, QA super feeder unit, sound sales components, 12 spare valves, s.s. output transformer 25:1, Magnavox 66 speaker 1.250 ohm field, Vought h.c. horn, complete equipment: £25—71, Cophorne Drive, Shrewsbury. [9154]

HALLICRAFTERS BC610E speech amplifiers, types BC614, B, C, D and E, including power pack, all tubes, reconditioned, fully guaranteed, £11, or ex-Government, as delivered, good, complete. £7/10; also available, reconditioned BC610E (HT4E) TXs, all bands 3.5 to 30 mc/s; HT14 marine 50-watt transmitter receiver.—Write for details, McElroy-Adams Group, Ltd., 46, Greyhound Rd., W.6. Fulham 1802. [9090]

RECEIVERS, all reconditioned and in first-class working order, H.R.O. Senior, rack mounting, complete with power pack for 230v a.c. and set of 4 bandspeed type coils, 1.7-30 mc/s, £45; Marconi CR100, 60 kc/s-30 mc/s, with speaker, £40; Eddystone 358X, complete with 10 coils, £45; 1224A 5-valve battery superhet receivers, 1-9 mc/s, brand new and unused, price £4/15 plus 10/- packing and carrier.—Tele-mart G5NI (B'ham), Ltd., 48, Holloway Rd., Birmingham, 1. [9332]

NEW LOUDSPEAKERS
DAILY demonstrations at Holley's Radio Stores of the following speakers: Goodman's Infinite Baffle, Sound Sales Phase Inverter, Barker Conert, Tannoy HF Dual, Acoustical Whiteface Golden and Golden other makes, also Sound Sales, Vortexion and Williamson amplifiers—285, Camberwell Rd., London, S.E.5. Rodney 4988. [9289]

LOUDSPEAKERS, SECOND-HAND
HARTLEY-TURNER, latest, 215—Osborne, 30, Fosseway Rd., Bath. [9262]
BA.E.C. hi/3 twin-con, 12in P.M., as new, £7/10 or offers—Box 5107. [9158]
VOIGT twin cone speaker, energizing unit, £18/10—5, High St., Swanscombe, Kent.
MAGNAVOX 66 in solid oak cabinet, with field rectifier and pilot light; £9—Box 5753.
HALP-WAVE packing cabinet with new Goodman 12in speaker, black and gold finish; £15—Box 5520. [9199]
VOIGT light twin unit, home constructors horn, quality amplifier, infinite baffle cabinet; reasonable offers—Box 5521. [9205]
FINCO PA type speaker units, 3 ohm, 20w. Admiralty pattern less horn, as new; 25/- ea. or offer for the lot.—H. English, The Maltings, Ray esh Rd., Hutton, Essex. [9248]

300 20w. Admiralty pattern less horn, as new; 25/- ea. or offer for the lot.—H. English, The Maltings, Ray esh Rd., Hutton, Essex. [9248]

DYNAMOS, MOTORS, ETC.
1KW Lion Norman lighting and charging 2 plants.
15HP single-cylinder petrol 4-stroke o.h.v. engine, air cooled by own blower, M.L. magneto, complete with control panel, including cut-out, first-class amp meter, sliding shunt control, etc.; output 20amps 12/18v; all mounted as one unit, with petrol tank, etc. etc.
WILL light on 12 or 24-volt circuit, fair-size house, bungalow, workshop, boat, etc.; an excellent standby in the case of fuel cuts; beautifully finished job throughout; new and tested before despatch; price £39, plus 20/- packing and carriage.—Fountain Engineering Co., Ltd., High St., Teddington, Kin. 1193-4. [9413]

BENMOTORS, new surplus bargains at fraction original cost.
 75/-, new dynamos, 24v 1,000w. 9inX7in. 1/2 spindle, or send 80/- carr. paid.
 65/-, new a.c. generators, 24v 350w, 1.250 cycles, 9inX7in, 1/2in spindle, or send 70/- carr. paid.
 78/-, new radio wave meters, micro adjustment dial, beautiful instrument in case, or send 80/- carr. paid.
 49/-, new 230v to 12v mains transformers incorp. a.c./d.c. switchboard with 7 power take-offs (cost £25), or send 53/- carr. paid.
HOST other valuable equipment, lists free.
BENMOTORS, Summerley St., Earlsfield, S.W.18. Wim. 3833 (100 yards S.R. Etl. line).
 10 mva. Warton, etc. [9263]

ROTARY converter, 230 dc-230 ac, 80 watts.
R new cond.: £7/10—265, Camp Rd., St. Albans. [9131]

ROTARY converters, ex-A.M., new, input 24v dc, output 230v ac, 100 watts; £5.—Wild's Radio, Victoria Rd., Fenton, Stoke-on-Trent.

FOR sale, E.D.C. converter, 110 dc./230 a.c., good cond., price £15.—Apply, Sir J. King, O'd Rectory, Netherbury, Beaminster, Dorset.

ROTARY converter (Ward) for sale, input R 230v dc, output 230v ac, 200w, 50 cy., run 10 hrs. only, as new, with box; £20 or nearest offer.—Seymour, 88, Herring Lane, Spalding.

DYNAMO 40 volts, 1.1 kw, 1,600 revs, very heavy brand new machine, £65, rotary converter, 110v D.C. to 110 A.C., 500w, 50 cy/e, as new, £17.—Barton, 41, Bedminster Down Rd., Bristol 3. [9288]

BATTERY chargers for home and export, 4 models, 2-20v, 2-2amp dc, any mains voltage; generous trade terms, write for catalogue.—Tel. Hoddesdon 2659, The Banner Electric Co., Ltd., Hoddesdon, Herts.

GENERAL LAMINATION PRODUCTS LTD

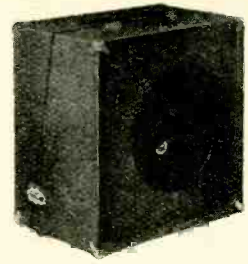

THE P-A-GRAM PORTABLE (AC)

A complete sound amplifier, speaker and playing-desk

FOR THE EXPORT DOLLAR DRIVE

Illustration shows amplifier unit, case and 10in. bronze speaker. A separate case contains gramomotor and pickup. Removable chassis 12/15 watt. P.P. Amplifier with HG mic stage, fader mixer, two inputs, 6J7, 6SN7, 6V6, 6V6, 5Z4. All housed in TWO handsome leatherette covered cases.

The P-A-Gram as outlined, £37 ex works. Microphone and stand fitted into main unit from £8 extra.

Another example in the carrying case style is P12/AC. Amplifier 12 watt with playing desk and pickups, £28. Speakers in carrying cases from £7.

OTHER MODELS AVAILABLE
 AC/6, 7 gns.; AC/8Q, 15 1/2 gns.; AC/10, 8 1/2 gns.; AC/19, 14 gns.; AC/10 Plus, £10; AC/19HG 16 gns.
 W.W. quality, 25 gns. Tone pre-amp, 5 gns.

Transformer for Sound Equipment. See classified advertisements.

If you have not communicated with us yet this year, write enclosing 6d. for Mail Service.

GENERAL LAMINATION PRODUCTS LTD.
 294, Broadway, Bexleyheath, Kent.

THE HARTLEY-TURNER SPEAKER

Although we have had a large number of congratulatory letters on the performance of the Model 215 we have not as yet published any "testimonials from satisfied users" mainly because it is rather taken for granted that a Hartley-Turner customer is satisfied—at any rate so far as sound reproduction is concerned. But the following letter seems to say what a lot of people would like to know:

"Your type 215 speaker justifies all that you have said about it. The results at first seemed rather mystifying owing to the complete absence of bass or treble resonances—the notes of music come out clearly from silence without any colouration of tone, and, too, without any of the usual focussing which one has grown apt to take for granted; a point which my wife appreciates, as it no longer means that in only one chair in the room can one hear really clearly. The bass reproduction is a revelation in clarity."

The Hartley-Turner speaker tackles the problems of high-fidelity in a very unorthodox way, and solves them triumphantly. The results are available at little more than pre-war price.

Model 215 **£9.** Plus Carriage.

If you have not already been in touch with us, send for illustrated leaflet.

H. A. HARTLEY CO. LTD.

152, HAMMERSMITH RD., LONDON, W.6.

Riverside 7387.

EX-R.A.F. rotary converters, 24v dc input, 230v ac out, 75watt, fitted in test set 65a osc. W. meter, 2 1/2 v valves and useful components. £7 carriage paid. Hurst Electrical Industries, Ltd., 75a, Well St., E.9. Tel. Amh. 4166.

Dc. to a.c. motor alternators, 200/250 volts d.c. input, 200/250 volts 50 cycles single phase a.c. output at 200 watts, screen protected, ball bearings, new. £12/10 each. —J. S. E. 11. Engineering, 319, Kennington Rd., S.E.11. Reliance 1412-3. 9207

SANGAMO synchronous motors, self-starting, 200-250v a.c., 50 cycles, consumption 2 1/2 watts, size 2 1/2 in diam, 2 in deep, geared 1 rev. 60 min. can be reset to zero by friction drive from front or back, to run clockwork, ideal movements for making electric clocks, time switches, etc., nickel plated finish, complete with 12 to 1 dial train, price 25/- each, postage 6d; blower motors, 12-24 volts a.c./d.c., dimensions 6 in long, 5 in wide, made by Hoover, Ltd., price 40/- each, postage 1/-; extractor fans, complete with 12v, 3 1/2 amps d.c./16 volts a.c. new, in original packing, price 20/-, postage 1/6; blower motors, 100-115 volts a.c./d.c., 6in x 5in, price 37/6 each, postage 1/-; rotary converters, input 12v d.c., output 230v a.c., 50 cycles, 80 watts, price £4 each, carriage 3/-, extra, rotary converters, input 230v a.c., output 230v a.c., 50 cycles, 80 watt, fitted in metal case, price £4 each, carriage 4/6 extra; ex-W.D. anastigmat lenses, f/3.5, focus 2in, as new, fitted in oxidised metal, flange, but not fitted with iris diaphragm, ideal for projectors, enlargers, cameras, etc., price 27/6 each, postage 6d, ex-W.D. lens, f/5.6, focus 1 1/2 in, 2 1/2 in, 2 1/2 in, deal for 16mm projectors, dimensions 1 1/2 in diam, 2 1/2 in long, price 20/- each, postage 6d; 16mm projection lenses, dimensions, diam 3/4 in, length 1 1/4 in, focus 2in, f/3.5, price 9/6 each, postage 6d; new Kodak leather cases, to fit Kodak Bantam 7/4.5 camera, price 20/- each, postage 6d; 16mm aluminium projector, 3 1/2 in diam, 5 1/2 in deep, 3/4 in diam, 2/9 per doz; 15 amp mercury switches, fitted with saddle and clip, 4/- each, postage paid; please send stamped addressed envelope for lists.—Tel. Mus. 9594. H. Franks, 58, New Oxford St., London, W.C.1. [9388]

807's guaranteed, new, unused; best all purpose tube for T.X's. Also P41s, 11/7.—Box 5761. [9415]

VALVES, new, at list price, 2,000 x 6AK5, 5,000 x 9001, 700 x EBC33, 900 x 12A6.—H. English, The Maltings, Rayleigh Rd., Hutton, Essex.

PHOTO electric cells, 1st grade cinema-television, 3.5, 2RT, 4-p.n. top cap, similar to G.E.C. VMG6, A.M. surplus, 25/- each, each tested in sound head circuit for full sensitivity.—Bryce Electrical Co., 246, Stockport Rd., Levenshulme, Manchester, 19. [9336]

GRAMMOPHONE AND SOUND EQUIPMENT
BRIBBLEY ribbon pick-up with transformer, boxed as new, £7.—Box 5541. [9262]

MERITE ribbon mike, stand, cable, transformer.—Preston, S'reatham 7458, after 6.

VORTEXION 8-way mixer, 2 gram input, £19.—Paragon Sound Studios, 66, Queen's Rd., W. Croydon. [9115]

QUALITY reproduction. The Trixonic concert reproduction, ex stock.—Teleonics, Ltd., 181, Earl's Court Rd., S.W.5. [9137]

TRANSFORMERS, tone control and filter chokes, for all "W.W." circuits.—R. Clark, 30, Langland Crescent, Stanmore, Middx. Wor. 5321. [7532]

RADIOGRAM, Philips 1939, a.c.-d.c. universal voltage, walnut cabinet, good condition; nearest offer, £75.—21, Hollycroft Ave., Wembley Park, Middx. [9196]

WALNUT veneer radio cabinet, fitted with electric gram motor and p.u., PX4 p.p. quality amplifier and t.r.f. tuner, also Baker 12in speaker, £20.—Box 568. [9110]

VOIGT P.U. and conductor, £10; Magnavox duode 33 speaker, 1.250 Ω field, £4; Vitavox 15in 20-watt P.M. speaker, £8/10; Philips Cine amp, 15-watt, incl. valves, 604, d.c./1.60, m.c./1.60, £10.—Box 5515. [9177]

CINE-VOX type CT records.—A limited number of copies available for the home market, complete transportable units in one case; send for illustrated folder.—Kine-Technic Services, Ltd., 60, Aylward Rd., London, S.W.20. [9177]

SAPPHIRE recording cutters and play-back needles, first-class work and quick service at moderate prices, turn cutters reground; we specialize in cutters for acetate discs.—Colton & Co., 575, Garratt Lane, London, S.W.18. [9245]

FOR everything appertaining to the quantity reproduction of radio records, Radio Unlimited invite your esteemed inquiry; new lists now available, prices, postage, 16, Carrington Rd., Leyton. Callers to 272, Romford Rd., Forest Gate. [9212]

FOR sale, a triple spring gramophone motor with turntable and pick-up, £3 or offer; also a 7in energized speaker with 100-watt transformer and metal record (about 20lb), 15/- each, offer.—"Golfways" Nursery, Hertford Rd., Hoddesdon, Herts. [9187]

BRITISH SOUND RECORDING ASSOCIATION covers all interests of the professional and amateur recording engineer and quality reproduction enthusiasts. "Sound Recording," the official journal, 3/-, No. 2, 2/6 per free.—Details of the Association and membership application form from Hon. Membership Sec. H. J. King, 48, Mount View Rd., N. Chingford, London, E.4. [9080]

STILL MORE BARGAINS

Selected from our wide range.

RELAYS. Siemens' High Speed lab., relays in brass case on ebonite circular base with contacts, £3 each. G.P.O. Polarized relays fitted contacts, in brass case with glass top and terminals, 45/-. Few relays with coils in good condition but less contacts, and soiled, 20/-.

GALVOS. D.C. moving coil suspension mirror Galvo, reflection type of Tinsley 100 ohms sensitivity 2 1/2 micro. amps per 1 inch of scale at one metre, in polished case with glass front, £8 10s. Moving coil bridge Galvo, flush panel, 2 1/2 in. scale 25-0-25, new, 75/-. Sub-divided Ohm Boxes by leading makers, .05, .05, .1, .2, 4, 2, 1, 2, 4, 10, 10, 40, 20, 20, with plugs, 40/-.

MEGGER. Evershed bridge megger with decade resistance box S.H. guaranteed. Evershed Wee meggers, new, from stock.

RESISTANCES. Var. slide vit. enamelled tube with laminated brush and slides, 14 ohms 5 amps., suitable with 50/70 volt dynamo for charging circuits at 5 amps., 25/- each. As new.

METERS. Ironclad A.C. voltmeters, G.E.C. 4in. switchboard, 0-60 volts, 45/-. Ammeters to match, 0-40 amps., 45/-. Frequency meter 40/60 c/s. Crompton F.G. Ironclad switchboard, 50 volts 6 1/2 in. x 6 1/2 in. x 4 in. with lamp on top to illuminate dial, £5 5s.; transformer for 230 volts A.C., 35/- extra. Voltmeter to match, 0-75 amps., A.C., 75/-. Voltmeter to match, 0-75 volts A.C., 65/-. D.C. moving coil, Elliott watch meter, 3 1/2 in., panel with back connection, 130/260 volts, 30/-.

TRANSFORMERS. Auto type, 230/110v, 85 watts 25/-, 100 watts 30/-, 150 watts 35/-, 350 watts 65/-, 1 K.W., £7 10s. Double wound transformers 230v/20v, 2 amps. 30/-, 12v, 3 amps. 32/6. B.T.H. Transformer, 200/230/250v., 50 cy. input 25 volts 20 amps. and 75 volts 6 amps. output with 15 taps, 70/- Carriage paid England and Wales.

DYNAMOS. D.C. 12 volts 10 amp. C.A.V., new condition; shunt wound, carbon brushes, £4. 50/70 volt D.C. 10 amps. shunt wound, ball bearings, 1,000 r.p.m., £14; 30 volts 5 amp., £5; 24 volts 40 amp. £10.

S W I T C H E S
Dewar key panel type, 7-pole C.O. flush fitting, 5/-; Yaxley 3-pole 3-way, 3/6; 3-pole 1-way, 3/6.



D.P.C.O. toggle switch 250v. 1 amp., flush panel, 3/3; 8-way Lucas switchbox, 3/6; 6-way, 3/1.

CIRCUIT BREAKERS. M.C.S., 7 1/2 amps. A.C., enclosed type, 21/-; 24 volt D.C. Solenoids, lift 14 lbs., 15/-.

SPARK COILS. G.P.O., 1/2 in. to lin. coil, 6/12 volt operation, 25/-; large 4in. coil on polished wood base, in new condition, heavy contacts, £12 10s. Mercury Interrupter, 110 volts D.C., £2 15s.

SPEED METERS. By A.T. Speedometer Co., 1,500 r.p.m., 4in. dia., black dial, white figures and scale, 20/-.

BATTERY SUPERSEDER. 6 volts D.C., input 230 volts a.o.m.a. D.C. output, for Radio receivers, 5 1/2 in. x 3 1/2 in., ball bearings, metal finish, 55/-.

TELEPHONES. Wall type constructors' parts, ex-G.P.O., comprising cabinet 8in. x 6in. x 3in., bracket mike, transformer and condenser, magnet, switch-hook and contacts, hand mag., ringer P.O. type receiver terminals and connection diagram, 35/- per pair.

MOTORS. D.C. 1/12th h.p., 110 volts, shunt wound, 25/-; A few similar machines, 110v. or 220v. needing repair, 12/6, carriage 1/6.

BATTERY CHARGERS. 230 volts A.C. for 6 or 12 volts car accumulators. Send us your enquiries and keep your car accumulator in condition while not in use.

MAGNETS. D.C. Electric magnets, weight 10 oz., lift on 2 volts 1 1/2 lb., 4 volts 3 lb., 6 volts 4 lb., new surplus, 7/6 each. Permanent powerful flat bar magnets, 2 1/2 in. x 1 in. x 1/8 in., drilled 2 holes each end, and any pole pieces, 2/- pair. The wonder Midget magnets. Alni perm. steel disc; 5/8in. diam., 3/8in. thick, with 3/16in. centre hole, 3/6 each. Large stock of Horseshoe magnets. Send for special Magnet Leaflet, "W.W."

Please include postage for mail orders.

ELECTRADIX RADIOS

214, Queenstown Road, London, S.W.8

Telephone: MACALVA 2159

230v AC gram motor, Paillard, perfect, offered in exchange for 230v Universal motor. Brierley ribbon P.U. and transformer. New, unwanted gift; offers.—Box 5080.

RECORDING equipment available from stock. A complete recording installation for £75. blanks, cutters, sapphires and special recording amplifiers; matching transformers ribbon.—University Recording Co., 16, Bureleigh Place, Cambridge. Tel. 54947. [9192]

PROFESSIONAL recording equipment; to the trade, recording machines, blank discs, cutters, trailer needles, etc., from stock; recording amplifiers, matching transformers, ribbon and m.c. microphones; full trade terms.—Sound Discs (Supplies), Ltd., 83a, Bold St., Liverpool. [9192]

TWO brand new Ball & Biscuit microphones. Complete with adaptors and swivel holders, designed as match pair by the Standard Telephone Company, cost price 35/- for sale £22/10 pair.—Mayfield Electrics, Ltd., 7, Station Parade, Virginia Water, Surrey. [9294]

MICROPHONES.—Fest S.T. & C. type 4021C. Condition as new at 1/4 usual price, the famous "Ball" mike, generally considered the best moving coil made, fine frequency response, exceptional sensitivity to weak sound, non-directional, minimum wind noise; £5.—S.P.A., Ltd., 11, Hillbury Rd., S.W.17. [9077]

VOIGT Domestic Corner horn, complete, £60; horn and bass chamber, complete, new, £45; Voigt half horn complete, new, £45; Voigt half horn and bass chamber, no unit, new, £17; Voigt pick-up with Diamond Stylus, little used, £12/10; another, £8; 2-h.f. high-quality tuner with Cathode Follower output (Lowther), £30.

FREQUENCY high-quality amplifier, designed for the highest performance regardless of price, 12watts output, gain 105db, total distortion 0.2 of 1 per cent, early stages r.f. heated to eliminate hum, pre-amp. includes bass lift for m.c. pick-up, paper-smoothing and decoupling condensers throughout, mica coupling condensers; used for experiments in test purposes only JOSEPH ENOCK, Ltd., 273a, High St., Brentford, Middlesex. [9188]

SH.E.P.I. moving-coil pick-up is now available for both home trade and export; it combines for the first time high fidelity with high output voltage, enabling it to directly replace normal moving iron pick-ups without any extra amplification; it has an exceptionally clean response with no undesirable resonances, thereby reducing needle scratch; price, in walnut and black plastic finish, 40/- each retail, including transformer, plus 10/4 purchase tax; wholesale and retail enquiries, try illustration sent on request; we are exhibiting a very large range of electrical and radio appliances and a variety of novelties in these lines at the Ideal Home Exhibition, from 2nd to 25th March, 1948, Stand No. 62, Household Appliances Section, Grand Floor, Grand Hall Olympia.—Brooks & Bohm, Ltd., 90, Victoria St., S.W.1.

TRANSMITTING EQUIPMENT

KAAR. PTS 22x transmitters using HY69s, 85/5; 1154 transmitters, £4; 230 to 110 volt 1 kw transformers, £2/10; all above goods in excellent condition, please send for details, Barton, 41, Bedminster Down Rd., Bristol, 3.

BC 610 Hallicrafters transmitter, as new, complete with auto transformer, modifications to meet 150watt requirements or for overseas requirements can be quickly converted to full power; this outfit includes a new amplifier, microphones, and all requirements, the transmitter covering 30mc to 2mc; will sell to best offer.—Box 5529 [9231]

TEST EQUIPMENT

COSSOR double beam 'scope; offers over £40. Box 5082. [9135]

AV O meter, tester overhauled by makers, 11 gns.—R. K. Wilson, Alnwick [9063]

COSSOR 339a osc. perf. cond., best offer over £40; Taylor 120A, £6/10.—Box 5109. [9161]

OSCILLOGRAPH exchange. HRO/AR88 R132, £5. TRF 6-valve £4; s.a.e. list.—Box 5773. [9161]

ADVANCE signal generator, little used, £14; A electric gram. playing desk, with p.u., £5.—Box 5049. [9111]

AV O mains sig. gen. unused, £12; Weston, 77y, new, £15.—Flat B, 15a, Thurlow Park Rd., E.9. [9298]

FREQUENCY meter type L.M.14 fitted with p.wer unit, instruction manual supplied; offers?—Box 5695. [9361]

UN I. Av. Minor, £4/10; Taylor's 110B, C and W bridge, what offers?—Dawson, 101, Harwood Rd., Rishton, Lancs. [9055]

MARCONI instrument Universal impedance bridge, TF373D, few hours' use only (new 1947), £69, carr. extra.—Box 5111. [9166]

FREQUENCY meter, B221, unused, £30; Weston E772, type 4, analyzer, as new, £16.—22, Newton Rd., Newcastle-on-Tyne, 7. [9300]

MARCONI EICO circuit magn. flat beam meter, almost new, unmarked; best offer secured.—Bolton, 28, Union St., Newton Abbot, Tet. 1070. [9166]

ONE new R.T.S. oscilloscope, single beam, cost price £45; offered for sale at £30, excellent bargain; fully guaranteed.—Vivian Electric Ltd., 7, Station Parade, Virginia Water, Surrey. [9292]

METERS, meters, meters.—We have stocks of all kinds, r.f., thermal, moving coil, voltmeters, milliammeters, microammeters, etc.; trade enquiries invited; send for list.—Pak 17, instruments, 195, Coppermill Lane, London. [9265]

YOU can become a first-class RADIO ENGINEER

We are specialists in Home-Study Tuition in Radio, Television and Mathematics. Post coupon now for free booklet and learn how you can qualify for well-paid employment or profitable spare-time work.

T. & C. RADIO COLLEGE
North Road, Parkstone, Dorset

Post in unsealed envelope, 1d. stamp.

Please send me free details of your Home-Study Mathematics and Radio courses.

NAME

ADDRESS
W.W.69.

WINDING REWINDING AND LOUDSPEAKER REPAIRS

individual radio transformers, armatures, fields, motors and bobbins.
PROMPT SERVICE
Now ready—"Telecraft"
Portable and Indoor
Television Aerial
35/-

Enquiries to

**Southern Trade
Services Ltd.**
297/299, HIGH STREET
CROYDON

'Phone : CRO 4870

ONE B.S.R. L50 B.F.O., £46; one advance signal generator, model B.3, type C, £25; one Labgear electronic fault tracer, £30; or near offer.—Astra Radio, Electra House, Haslemere.

NEW Avo test bridge, £11; second-hand Avo Model 7 Universal, perfect cond., £10/10; second-hand Sangamo Weston, B.665 selective analyser, perfect cond., £10/10.—B. W. Brighty, Abridge, Essex. (9052)

FREQUENCY meter BC.221.—Crystal control 126 kc/s to 20 mc/s accuracy better than 0.01%; new £45; 45-page manuals giving circuit and full details 7/6.—V.E.S., 46, Windmill Hill, Ruslip Manor, Middlesex.

MARCONI-EKCO standard signal generator. 85kc/s to 25mcs/sec. int or ext mod. accurate attenuator, perfect. £70; Marconi distortion factor meter, price £20; or exchange 1 for 16mm cine camera of similar value.—Box 5662.

SIGNAL generators, resistance-capacitance bridges, inductance meters, inductance bridges, square wave generators, etc. instrument cases from 7/6; technical data lists available; hire purchase terms.—Radio & Electronic Development Co., Moretonhamstead, Devon. (9209)

MICRO ammeters, 0-200 FSD, oblong scale 4 1/2" x 2 1/2", in heavy cast or brass box. 9" x 6 1/2" x 3 1/2", superior instrument by Evershed Vignolles, £4; Ferranti MC, 0-40v 2in square, 10/-; Television Development Co., 4, The Parade, High Rd., Kilburn, N.W.6. (9418)

NUPLANS do it again! To match our popular "Tracette" pocket signal tracer, pop in the other pocket our "Genette," a se.f-contained midge signal generator; a perfect pair for fault-finding and aligning and which requires no mains supplies; each plan 2/6. circuit, lay-outs, notes, etc.—E. Bradley, Winnie Knowe, Sennen, Cornwall. S.a.e. list. (9308)

WEE meggers, brand new comp. in leather case, ex-R.A.F., few left, 250 volt, £3 (list £12); electrostatic voltmeters, 0-5,000 E.I. Co., 3 1/2" in flush, 30/-; ammeters 0-20, M.I.P., 2 1/2" in flush, 10/-; milliammeters 0-350, Sangamo, Weston, 2in proj., thermocouple, H.F., 5/6; ditto Ferranti 0-200 m.a. 7/6; all brand new and boxed in coil insts.; hydrometers, ex-R.A.F., unbreakable glass, new, 3/6.—Auto Collections, Ltd., 126, St. Albans Ave., W.4. (Chiswick 1601.)

FOR sale, 1 high-frequency valve generator, Philips type F.12/1, capable of inducing 5kw energy into work coil, unit in new condition, and perfect operating order, equipped with high-grade measuring instruments for indicating: filament volts, anode current, grid current and h.f. current, also electronic timing device; a spare oscillation valve, Mullard type TX10-4000 (silicor envelope), is clipped into the cabinet, also two spare RG3-1250 mercury vapour rectifying valves; overall dimensions 4ft 5in x 3ft 6in x 9in; an ideal plant unit for many phases of clean and directed process heating by the Eddy current method; for educational institutions, such would prove a really satisfactory means of demonstrating the numerous applications of high frequency heating; price £1,000.—Apply to Box 5516. (9308)

COMPONENTS—SECOND-HAND, SURPLUS SOUTHERN RADIO'S wireless bargains?

LATEST radio publications, Radio Valve Manual, British and American valves, alternatives and equivalents, 3/6, post 3d; all publications previously advertised still available, send 2/6 for complete list; A.C. motors, 200-250 volt, 1/4hp 1/2 amp, ideal for light work, etc., £2/15 each plus 5/- carriage; throat microphones, brand new, with 3ft lead and plug, 4/6, post 6d; two throat microphone inserts, 3/6, post free; permanent crystal detectors, 2/6, post 4d; R.A.F. R/T testers, 2,500-6,700 kc/s, 45-120 metres, complete with two valves, in aluminium carrying case with leather handles, 16in x 10in x 6in, 20/-, post free; R.A.F. morse keys, 2/6 each, post 4d; input transformers, ratio 1:50 mu. metal, 4/6, post 1/-; ratio 1:7 mu. metal, 4/6, post 1/-; condensers, 0.1+0.1+0.1, 2/6, post 3d; oil filled, 0.1 mfd 7,500v D.C., 7/6, post 1/-; 0.5 mfd 7,000v a.c., 7/6, post 1/-; "Lufbra" adjustable hole cutters for use on wood, metal or plastic, 5/-, post 6d; Midget twin gang condensers, 75 p.f., 5/-, post 6d; Midget single gang condensers, 75 p.f., 2/6, post 6d; ex-Army headsets, carbon mikes and moving coil earphones, 12/6, post free; moving coil (15 ohm) P.M. speakers, 3 1/2in, brand new, £1, post 1/-; Tanoy carbon mikes, 2/6, post 3d; M.C.R.I. batteries, 7 1/2 volts L.T. and 90 volts H.T., 6/6, post 9d; T1333 transmitters, brand new, with hand generator, two valves, crystal, 200ft aerial, range 125 miles, in transit case, £2/15, carriage 5/-; Westectors, W.X.6 and W.112, new, 1/- each, post 2/4d; generators brand new, 12-480 volts O.C., 10/-, post 1/2; condensers, 12 assorted, Mainbridge type condensers, capacities 0.5, 1, 2 and 4 mfd, 12/- per doz., post 1/-; valve holders, International Octal, moulded or paxolin, 9/- per doz., post 6d; telephone line units, with rectifier, re'ay, two jack sockets and indicator lamp, in wooden case, 5/-, post 1/4.

SOUTHERN RADIO SUPPLY Ltd., 46, Little St., London, W.C.2, Gerrard 6653. (9387)

BRAND new goods, chokes, 6H 300ma super job, shrouded, wt. 6lb, 8/3, post 1/3; Amphenol Co-ax, 3-piece plugs/sockets, 9d, Pyc Co-ax tops, 4d plus postage.—Austen, 28, Vauxhall Rd., Burgess Hill. (19044)

AMERICAN MAGAZINES

In the following list of Famous American Publications is a magazine you require.

| | |
|-----------------------------------|-------------------------|
| | One year |
| RADIO MAINTENANCE | 17s. 6d. |
| "CO" THE AMATEUR JOURNAL | 17s. 6d. |
| "QST" THE A.R.R.L. MAGAZINE | 20s. 0d. |
| AUDIO ENGINEERING | 20s. 0d. |
| RADIO CRAFT | 22s. 6d. |
| RADIO NEWS | 25s. 0d. |
| THE RADIO AMATEUR CALL BOOK | 35s. 0d. |
| ELECTRONICS | 75s. 0d. |
| TELE TECH | (2 years only) 37s. 6d. |
| | One year |
| REFRIGERATING ENGINEERING | 17s. 6d. |
| POPULAR MECHANICS | 17s. 6d. |

Send your remittance and order to us and we will arrange for the American Publishers to forward you regular monthly copies post paid with the minimum of delay.

DALE INTERNATIONAL Publications Ltd.

105, BOLSOVER STREET, LONDON, W.1

Telephone: Museum 1023



NEW G.P.12 CRYSTAL PICK-UP

with permanent sapphire stylus

—was fully described in *The Wireless World's* recent article "Crystal Pick-ups—Basis of Design for Fidelity Reproduction."

This remarkable pick-up, which represents the ultimate in high-fidelity reproduction, is now available in limited quantities through your radio dealer, price 96/- incl. P.T.

FREE ILLUSTRATED FOLDER describing this new pick-up may be obtained by returning the coupon below.

TO COSMOCORD LTD.
ENFIELD, MIDDXX.

Please send folder of ACOS Pick-ups.

NAME

ADDRESS

W.W.

CHARLES BRITAIN (RADIO), Ltd.
 EX-U.S. Navy aircraft radio receiver unit; this outfit is complete in a black metal case, size 12x12x8in., and contains in addition to a host of useful components, ten international aerial metal-cased valves, including a 6BE6, 6SH7, 2 7193, super quality rotary generator with carbon pile, voltage regulator, relays, I.F. transformers, etc. The generator can be very easily converted into a motor working from 200-250 a.c. or d.c. mains; it will then have 7,000 r.p.m., and be sufficiently powerful for a bench grinder, small lathe, etc. Price for 39/6 ea., plus 7/6 carriage and packing. (We regret this inadvertently appeared at 29/6 in previous issue.)
 SPECIAL offers: combined moving-coil mike and headset (3 moving-coil inserts with Alni magnets), on-off switch on microphone, price 9/6 post free, high-voltage condensers, 4mfd Mansbridge, 1,000v wkg., 5/- ea.; 5mfd, 3,500 wkg., 3/6 ea.; 25mfd, 2,000v wkg., 1/6 ea.
 MAINS transformer, 350-0-350 80ma 6v and 5v, 200v to 250v primary, brand new G.E.C. case-through type, 12/6 ea.
 We regret the delay in sending out "W.W." lists. New ones are now available. Please send 2/6 stamp.

CHARLES BRITAIN (RADIO), Ltd., Radio House, 2, Wilson St., London, E.C.2. Tel. B5. 2966. [9411]

CLYDESDALE for ex-Services electronic barracks.
 BRAND new half-wave dipole aerial with reflector and crossarm, 6 metres vertical or horizontal mtg. to wall bracket or mast, dipole 9ft 3in., crossarm 4ft 11/4in., reflector 9ft 7in., with 39ft co-axial cable and plug, at 21/- each, c/paid, or in wood case at 28/6, carriage paid; plus new R.1284 aerial with superhet, 5 valves, 3 wavebands, 30-300 metres, complete less batteries, at 25/14/6, carriage paid; brand new R1481 V.H.F. R.X., 65-86m/cs with 10 valves and stabilizer, less power supply, at 29/14/6, carriage paid; brand new R.1132 V.H.F. R.X., 100-124m/cs, etc., as R.1481, at 21/0/14/6 each, plus 1,000s of other items.—Send for illustrated list to Clydesdale Supply Co., Ltd., 2 Bridge St., Glasgow, C.5. Tel. South 2706. [9314]

G. W. SMITH & Co. (RADIO), Ltd., offers the following:
GUARANTEED sound and perfect: R.A.F. type 39 aerial coupling units with 41 and 0-6amp coupled meters and 100vct dummy aerial, 17/6 each; 1,000kc crystal units, new and boxed, 10/6 each; R.A.F. R1124 receivers, 41.3mcs, complete with valves, very easily adapted for television limited number only, 59/6 each; Admiralty 149, speed dials, very fine scale, 4/6 each; condensers, 1mfd 5kv working, 10/- each; 25mfd 2kv working, 2/6 each; R.A.F. output testers with 2-volt valves suitable for adapting to 5-metre receivers, brand new, 19/6 each; E.F. 50 valve holders, Pax 6d., ceramic 9d., Octaloid 7-pin 6d. each; I.F. receivers, complete with valves, 29/6; selector 24volt step in relays, 1/6 each; 12volt stater relays, 3/6 each; 18 and 24-way screened cables, 4/6 each; 8volt 1/2amp rectifiers, 3/6 each; 5ma rectifiers, 2/3 each; 60ma L.F. chokes, 2/6 each; 0-20volt ac meters, 2/4 in scale, 10/6 each, plus carriage.
G. W. SMITH & Co. (RADIO), Ltd., 3, Lisle St., London, W.C.2. Gerard 8204. [9117]

SAMSONS SURPLUS STORES, London's greatest surplus depot.
SUNVIC vacuum relays. Control voltage 220-240v, breaking load 350watts, brand new, 22/6, post. 6d.; condensers, 2.25mfd, 2,000v, wkg tropical, 7/6; 6mfd 1,500v wkg, d.c., 5/6; 4mfd 800v wkg trop, 5/6; 4mfd 400v wkg trop, 3/-; 4mfd 350v wkg trop, 2/6; telephone hand generators, brand new, 5/6; Admiralty power packs, input 200-220v, output 2.5v d.c., 6.3v a.c., complete, smoothed and rectified for diode valve sets, 32/6, plus carriage; C.R. tube units, type 12C, complete with 2 tubes, types VCR5177 and VCR139, fine selection of components, including 3 VR65s, 1 6J55, 4 diodes, brand new, dispatched in wooden packing case as from makers, 24/10, carriage 5/-, no c.o.d.; receiver type 3170, 14-valve radar unit, brand new, 1948, priced with 10 EP50s, 1 HVR2, 1 U14, 1 VST0, 1 VR137, resistors, condensers, chokes, etc., dispatched in maker's packing case, 24/10, carriage 5/-, no c.o.d.; M.C.R.1 miniature receivers for mains or battery, frequency range, 20-3,000 meters, complete with power supply unit and output transformer, 100v-250c a.c. or d.c., 2 batteries, phones, aerial, earth, etc., brand new, sealed in air-tight canisters, 21/10, without power pack but with 3 batteries, 28/10 ea, carriage 3/-, no c.o.d.
SAMSONS SURPLUS STORES, 169-171, Edgware Rd., W.2. Tel. Pad 7851. [9274]

1,000 watts lists are sent out each month. Do you receive one? Many bargains in components and American valves; trade list available.—Watts, 38 Chapel Avenue, Addlestone, Surrey.
MICA condensers, 1 to .01, 8d each, 7/- doz; 25v, 14-valve radar unit, brand new, 1948, priced with 10 EP50s, 1 HVR2, 1 U14, 1 VST0, 1 VR137, resistors, condensers, chokes, etc., dispatched in maker's packing case, 24/10, carriage 5/-, no c.o.d.; M.C.R.1 miniature receivers for mains or battery, frequency range, 20-3,000 meters, complete with power supply unit and output transformer, 100v-250c a.c. or d.c., 2 batteries, phones, aerial, earth, etc., brand new, sealed in air-tight canisters, 21/10, without power pack but with 3 batteries, 28/10 ea, carriage 3/-, no c.o.d.
SAMSONS SURPLUS STORES, 169-171, Edgware Rd., W.2. Tel. Pad 7851. [9274]

ARMSTRONG

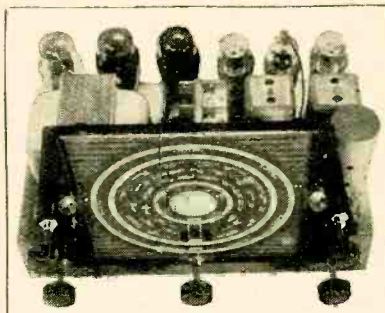

Model RF103 10 VALVE ALL-WAVE SUPERHET RADIOGRAM CHASSIS.

SPECIAL FEATURES

- ★ 10 VALVE CIRCUIT.
- ★ R.F. PRE-AMPLIFIER.
- ★ WAVE BAND EXPANSION.
- ★ LARGE GLASS SCALE.
- ★ 3 STAGES A.V.C.
- ★ TREBLE LIFT CONTROL.
(Operates on both radio and gramophone.)
- ★ PLUS 6 db. BASS LIFT ON GRAMOPHONE. (To restore bass cut on some records.)
- ★ 10 WATT PUSH-PULL OUTPUT.

To export buyers we can confidently recommend RF103 to any firm abroad who contemplates making a high-grade Radiogram or Console radio receiver.

The lively short-wave performance coupled with the excellent quality reproduction ensure an outstanding performance.

We will gladly make any alterations to the specification to meet individual requirements.

To home buyers demonstration model now available to interested callers to hear, and technical specification now available on request.

It is hoped that a number (very limited unfortunately) will be available for early delivery.

The above model is for A.C. Mains. We also have a similar model Type UNI 103 for DC/AC Mains.



ARMSTRONG WIRELESS & TELEVISION CO. LTD.
 WALTERS ROAD, HOLLOWAY, LONDON, N.
 Phone: NORth 3213

MAINS trans. P200-250v and 350v, sec. 4v 4a 4v 2a, 10/6; list of radio parts 1d env.—Williams, 28, Stanley Ave., New Malden, Surrey.
BC342, complete coil, switch, tuning gear, 11 s.f.s. dual controls and circuit; 25/10 or near.—Parrett, 15, Farmcombe Rd., Tunbridge Wells. [9371]

TUNING scale, glass, 8x5, 3-wave, in three colours with drum, drive spindle, pointer and backplate, 15/6 each.—Will Owen, 538a, Mansfield Rd., Nottingham. [9124]

150 type 362 A.C. mains 50cs power units, 120 m/a or 600v or 70 m/a at 700v as new; 22/15 ea. or offer for the lot.—H. English, The Maltings, Rayleigh Rd., Hutton, Essex.

TELEVISION aerial equipment, 5 types fully waterproofed aerials available, poles, lashings, all types of feeder in stock; send for brochures; aerials installed.—Wiseley Television, Ltd., 87, Brixton Hill, S.W.2. Tulse Hill 1240.

FEW only surplus factory made s/het chassis, 11in x 5 1/2 in x 2 1/2 in, fitted m.w. and l.w. a.e. osc. and I.F. coils, 2 gang, w/change sw. valve holders, 16x16mfd, 41/6, post free.—Write 69, Geneva V. Avenue, North Harrow, Middxsex.
MARAC 200-240v 50 cs, 2 tubes, 1 6BE6, 1 6X4, 5gns; Marconi B.F.O. TF195L, 280; cond. 0.1 4,000v dc, 3/6; BC221 frequency meter, 15gns; 1191A frequency meter, 7gns; H.R.O. and Edvstone coils.—Parrett, Swithland Lane, Rothley, Nr. Leicester. [9417]

THREE-STAGE resistance capacity miniature amplifiers with three tested 1T4 midget valves, 20/- each, post free; aluminium case, 22/-; spare 1T4 valves, guaranteed 6/- each; holders 6d. each.—Littler, 24, Stanley Rd., Whalley Range, Manchester, 16.

COPPER wires, enamelled, tinned, Litz, cotton, silk covered, all gauges; B.A. screws, nuts, washers, soldering tins, eyelets; ebonite and laminated bakelite panels; labels, coil formers; Tunford rod; headphones, flexes, etc.; list s.a.e.; trade supplied.—Post Radio Supplies, 33, Bourne Gardens, London, E.4.

POWER pack for Canadian 58 set and set spare valves, 150/- complete; 1/speakers 3/6in. Bin.; 6v telephone type 120v at 100v; Carr fastener, Celestion Int/coil v/holders, condensers, vibrators, v/controls, line cord, 6/12v vibrator transformers.—B. Martin, 17, Woodman Rd., Brentwood, Essex. [9291]

R.K. Senior and rect., 24/10; Magnavox 8in. P.M. with trans., 25/-; conds., well known makes, 0.0002 15/-, AF5c 15/-, OPM3c 12/6; 2 totally enclosed 0.0005 var. conds., with trimmers, 12/6 each; 3in Midget spkr. 3 ohm, 15/-; Post ex.; asstd. parcels of useful components. [9415]—Barker, 5, High St., Swanscombe, Kent.

MANUFACTURERS; huge stocks all components, S.M. M/N, P, and block, condensers, close tolerance resistors and all types of resistances, potentiometer, laminations, valve holders, glass cartridge fuses, 1/4in; suppliers to leading manufacturers; all goods guaranteed.—L. E. Simmonds, 10, Valencia Rd., Stanmore, Mx. [9155]—Simms & Co.

VIBRATOR transformers, 1,500 6v to 150v 40 m/a, 600 12v to 250v 80 m/a, 10,000 Xaxley type 9v single pole selector switches, 1,000 A.C. motor-operated switch units, 5,000 'phone and mike sets, reed type, MC and LR type, 100 CRTs, VCR97, brand new, at list price.—Enquiries to H. English, The Maltings, Rayleigh Rd., Hutton, Essex. [9250]

CONDENSERS, 2.2 to 100pf, 10 different values, 1/9 doz., your selection; 270 to 890pf, 0.001 to 0.02, 3/6 doz.; 0.05, 0.1, 4/6 doz.; 0.25, 0.5, 6/- doz.; bias elects., 10/50v 1/3, 50/12V 1/6; valve holders, 4- and 5-pin, Eng., 4d. ea.; 4- and 5-pin American, int. octal, 5d. ea.; EF50 ceramic, 8d. ea.; s.a.e. for bargain list; Hoyle, 320, Dewsbury Rd., Wakefield. [9305]

UNIVERSAL ELECTRONIC PRODUCTS, 36, Marylebone High St., London, W.1. Tel. No. Wel. 4058. Precision-built gearbox dial drive units, giving 2 ratios, 8-1 and 90-1. Entirely free from backlash. Few only; 18/6, post free. Send s.a.e. for particulars of our high-performance superhet tuning units. Special receiving or transmitting equipment constructed to specification. [9145]

KITS of radio receivers from 24/8, 4- and 5-valve, new materials, table models, semi-rigid, our latest design, with 1948 connections for gramophone pick-up, extensions to loudspeaker, A.V.C., 6 hours average time for constructing; full details, diagrams with each kit, c.w.o. or c.o.d.—Isherwoods, Remé House, 81, Plungington Rd., Preston, Tel. 3548, Estd. 1878.

HEADPHONES—Reed driven precision instruments, huge purchase, brand new, boxed, ex-Army D.L.R. double No. 2 comp. with 8ft c.w.s and tel. p.u.s; these are not cheap lightweight type, post free 7/6, or 2 for 12/-, or 60/- doz.; export enquiries invited.—Auto Collections, Ltd., 126, St. Albans Ave., W.4. [9389] wick 1601.

I.F. transformers, 9-11 megs variable, suitable for FM or television units, 10/6 each; BFO units, 465 kc/s with fly leads, 3/6 each, condensers, 8mfd paper, 1,000v wkg., 17/6; 4 mfd 2,000v wkg., 10/6 chokes, LF 20h 200 ma 140 ohm, 25/-; 5h 200 ma 110 ohm, 8/6; ex-R.A.F. trans. receivers, I.F.F., 24v Type 1 valve, motor generator, etc., 50/-; components wrch d. uble; ex-R.A.F. amplifiers, battery, PQQ2 va ves, complete in case, 17/6.—Television Development Co., 4, The Parade, High Rd., Kilburn, N.W.6. Mai. 3991. [9419]

Specialists in

HIGH POWER - HIGH QUALITY

PUBLIC ADDRESS SYSTEMS

★ AMPLIFIERS

from 150 W to 1kW

W. Bryan Savage Ltd
WESTMORELAND ROAD, LONDON, N.W.9

Telephone: Colindale 7131

SOLDER the NEW Way!

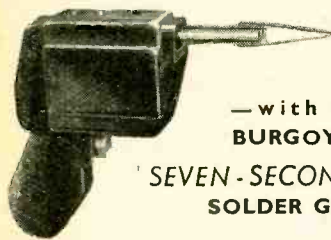

— with the
BURGOYNE
'SEVEN-SECOND'
SOLDER GUN

Press the button, count seven, and **SOLDER**... and the bit will remain at soldering heat until you release the pressure, when it cools off immediately.

Saves Time, Temper, Trouble and Fuel

No waiting to warm up or cool down—no element to burn out—no mica to crack or splinter—no risk of shock—no risk of burning anything while you put the iron down for a minute. No wonder the 'SEVEN-SECOND' SOLDER GUN is proving so popular.

Supplies are limited, so **ORDER NOW.** For A.C. mains, 200-250 volts.

£4 Carr. Paid

M.O.S. MAIL ORDER SUPPLY CO., Dept. W.W.

24, New Road, London, E.1
Stepney Green 2760-3906.

AMERICAN BC810 tuning units, with 3 variable 1/4in shaft condensers, D.P.D.T. switch coils, crystal holder, plated case, etc. 8/-; new ID8 Octal 1.4 volt multi-valves, 20/-; new 954, 955 acorns, 10/-; new 957 acorns, 1.4 volts, 10/-; all post paid (send for lists of metal valves, lighthouse valves, A.C. relays, transformers, vibrators, chassis and components). Jack Cooper, Ltd., 22-31, Colledge St., Worcester. (9030)

EARPHONES, low impedance with plug, 4/6; transformer for same, 3/-; carbon mic with switch handle, 5/6; Morse keys with switch, super job, 5/-; twin gang .0001 tuning condensers, long spindles and feet, 3/9 each; Amphenol valve holders, international, 7d each, 6/- doz; Mazda octal, 4d each, 3/9 doz; Yaxley type switch, 3 rank 1 pole, 6 way each bak. 1/- each, 9/- doz.—Will Owen, 538a, Mansfield Rd., Nottingham.

RADIOEQUIPMENT Co., Raunds, Northants.—Government surplus, C.R. tubes, 2 1/2in. with holder, etc., 25/-; r.f. units, 3xVR65, 5-way 3-wafer ceramic switch, etc. £1; rotary transformers, 12 and 24 volt types, 30/-; BC453B receivers, no valves, 3 IPT, 24-28 volt dynamotor, etc. 30/-; post or cartage, paid on all above; thousands of sockets, co-axial connectors, microphones, resistors, capacitors, valves, etc. list: s.a.e. please. 19039

1948 feeder units.—Complete range of aligned and calibrated feeder units with accurately printed station named scales; model A3, s.m.l. wave frequency changer and i.f. stage; model B3, s.m.l. wave, F.I. stage, f.c., i.f., and double diode triode; model B5 de Luxe, 3 stage wave bands, m.l., 15inx14 1/4in scale, Magic Eye.—Send 2/4d. stamp for illustrated brochure to sole distributors, Couplphone Radio, 58, Derby St., Ormskirk, Lancs. 19313

TELEVISION constructors!—We have the following in small quantities: The new G.E.C. flat-ended 9in C.R.T. Mazda CRM91 9in rubber masks, E.H.T. line trans., focus and scanning coils, solifomers, 1/2in threaded dust iron cones adjustable, mains trans., chokes, condensers, ceramic valveholders, Senter-cel. H4/200 rectifiers, H.V. rectifiers: SU2150, U21, IW4/500, FW4/500; 1,000 other valves and components; all goods are new at manufacturers' list prices; send for lists.—A. Farritt, 15-27, Wastley Rd., Forest Hill, S.E.23. 19200

TELE-RADIO (1943), Ltd.—Miniature 2-gang condensers, 0.00035mfd, 11/6 each; 4-gang 0.0005 condensers, 19/6 each; Belling & Lee 5-pin p. and s., 4/5 each; Belling & Lee 7-pin p. and s., 5/- each; co-axial cable, 3/8 dia., 2ft lengths, with plug each end (ex-W.D.), 5/-; mains transformers, type T500/180EX, 500/0, 500/180ma, 4v at 4a, 4v at 8a, 4vol-2a, 4vol-2a, £3/19/6; T.M. 600/180AX, 600-500-400-400-500-600 at 180ma, 5volts at 3 amp, 6.3volts at 5amp, £4/7/6; all above items are in stock.—177a, Edgware Rd., W.2. Paddington 6116 and 5606.

'RADIO SERVICE', East Cliff, Lyme Regis. Dorset, for all your components, new goods only: electrolytics, all 150 v w.v.; 2 μF 3/3, 16 μF 4/6, 25 μF 25 v w.v.; 50 μF 12 v w.v. 1/6; mains droppers, 0.2 amp and 0.3 amp, from 3/6; speaker transformers, Bulgln Midget, 3/-; standard multi-ratio, 7/6; vol. controls, all values, less switch, 4/-; with s.p. switch, 5/-; Rockman solder gun irons, 230v, 23/6; electrical goods, 2-pin 5 amp switch plugs, 4/6; pear switches, 2/4; torpedo switches, 2/-; insulation tape, 25 vds x 1/4in, 1/-; earth clips, 4d; enquire for any item not listed; prompt c.w.o. or c.o.d. service. 19182

BUILD your own receiver: Basic kit for 5-valve ac/dc superhet comprises three-wave-band coil pack already wired to wave-change switch, smoothing condensers, chokes, volume control, mains dropper, two-gang condenser, and valve holders, all mounted on ready drilled chassis, 1 3/4inx5 1/4inx2 1/2in, also dial drive, pointer and dial, only needs wiring and small resistors and condensers, which can be supplied separately as a supplementary kit; valves (6K3, 6K7, 6Q7, 25A6, 25Y5G), loudspeaker and attractive veneered cabinet measuring 20inx12 1/4inx8 1/4in, can also be supplied if required, wonderful performance and tone, all necessary instructions, diagrams and circuit provided with each kit; basic kit only £4/18/6, diagrams and instructions only 5/-; completed kit will be demonstrated with pleasure in our showrooms.—'Electron' (London), Ltd., 31, Curzon St., London, W.1. Tel. Grosvenor 1993. 19164

VALUET, Matt has it.—Special offers: Headphones, w/lead and jack plug, 5/6 pair (boxed 2 pairs), 60/- doz pairs; silver mica condensers, asstd. valves, 3/- doz, 24/- gross lots; fixed condensers, metal block type, .03-15-2 and 4mfd, 200-400-1 w.orking, 1/- each, 10/6 doz; condensers, .002, 2/6 per doz; .0006, 3/10 doz; .01, 9/- doz; .05mfd, 4/6; 8mfd, 2/6; 2mfd, 6/6; 16-18 canned, 8/-; 75mfd 12v working, 2/- each; speakers, p.m. (less trans), 4in 17/6, 5in 13/6, 8in 27/6, trans to match 5/6, universal trans 7/6; line cord (still available at our special price), 3 amp (600 hms pr ft) 2-way 1/6 per yd., 3-way 2/6 per yd.; volume controls, 2-in (central), various values, L/S 3/6, W/S 4/9; 2-gang condensers, Po'ar m'dget, .0005 12/-, not m'dret 5/6; Rothermel crystal pick-ups, de Luxe £2/5, P/T 16/11 extra; television cable aerial (lead in), 1/6 per yd; twin feed (insulated), 1/9 per yd; largest assortment of valves always in stock; let us have your enquiries.
MATT RADIO SERVICE Kingston 8353. 29, Castle St., Kingston-on-Thames, Surrey.

HENRY'S

We have the most up-to-date stocks of radio components for the amateur and radio service-man.

DRY BATTERY VALVES. We can definitely supply from stock, DK32 (IA7) at 13/11, DL45 (IC6) at 12/-, DP33 (IN6) at 12/-, DAC 32 (1H6) at 10/-.

Also for ultra-midget constructors, IR5 at 15/10, 8S4 at 14/-, IR4 at 14/-, IS5 at 15/10. All above prices are inclusive of P. Tax.

We have in addition many other "difficult" types, including 3BL6GT, 25A6, 4B, 1B, 6SL7GT, 6V6GT, 3SZ4GT, 12K7GT, 12BA7, 25Z6, etc., at current controlled prices.

ULTRA-MIDGET COIL FORMERS. Size 1in x 1/2in. Polythene, complete with iron dust core, mounting feet. Unparalleled bargain. 9d. each only (minimum quantity 6).

I.F. UNIT. Comprising IT4 valve, 1 midget iron-core I.F. transformer, 465 Kcs, 8 midget resistors and condensers, complete in aluminium can, size 4 1/2in. x 2 1/2in. x 1in., only 15/-.

ELECTROLYTICS. Special offer of brand new 32 mfd. 350 v. ultra-midget can, size 1 1/2in. x 1in. only. Leading make. 4/6 each.

We also have in stock a complete range of tubular and can type electrolytics by leading manufacturers.

VIBRATOR POWER UNITS. 2 volt. As for Canadian 58 set. Completely smoothed. Output 1.5 v. L.T. and 90 v. and 180 v. H.T. at 35 m.A. Complete in grey metal box. Size 8in. x 3 1/2in. x 4 1/2in. In addition are supplied two 2 v. 20 a. accumulators in metal case, complete with plugs, sockets, etc., for easy supply to unit. The whole at 70/- only. Brand new and unmarked. A bargain.

WEARITE "P" COILS. Full range in stock, 3/- each.

Our New List containing everything from solder tags to Cabinet will be despatched on receipt of stamp.

CASH WITH ORDER, OR C.O.D. OVER £1.

5, HARROW ROAD, W.2
PADdington 1008/9

ALEC DAVIS Supplies LTD.

18, Tottenham Court Road, LONDON, W.1.

In addition to a comprehensive range of radio components, valves and test equipment, we draw your attention to the following selection of components from our ex-Government stock.

METERS (all new and unused):

| | |
|-------------------------------------|-------|
| 0/100 microamps 2 1/2in. round face | 21/- |
| 0/600 microamps 2 1/2in. round face | 10/- |
| 0/500 microamps 2 1/2in. round face | 18/11 |
| 0/1 milliamper 2in. square face | 7/6 |
| 0/6 milliamper 2in. square face | 7/6 |
| 0/160 volts 2 1/2in. round face | 7/6 |

Postage on meters 6d. each.

CONDENSERS:

| | |
|--|-----|
| 8 mfd. 600 v. wkg. paper condenser, 4in. x 2in. x 1/4in. high | 6/- |
| 8 mfd. 400 v. wkg. paper condenser, 3in. x 1 1/2in. x 5/16in. high | 5/- |
| 8 mfd. 500 v. wkg. paper condenser, 3in. x 2in. x 3/16in. high | 5/- |
| 4 mfd. 1,000 v. wkg. paper condenser, 2 1/2in. x 1 1/2in. x 5/16in. high | 7/6 |
| 4 mfd. 400 v. wkg. paper condenser, 2 1/2in. x 2 1/2in. x 2 1/2in. high | 3/6 |

Metal cased tubular condensers with wire ends, 0.1 mfd./500 v., 10d.; 0.02 mfd./750 v., 8d.; 0.05 mfd./500 v., 8d.

| | |
|-------------------------------------|-----|
| 0.01 mfd. 500 v. | 1/3 |
| 0.05 mfd. 350 v. | 1/3 |
| 0.005 mfd. 350 v. | 1/3 |
| Metalpack 0.25 mfd. 500 v. | 1/6 |
| Micropack 0.5 mfd. 12 v. reversible | 1/9 |
| Micropack 25 mfd. 50 v. | 2/9 |

Ceramic compression mica trimmers, 80 pF, 1/-; 220 pF, 1/3; 600 pF, 1/6.

MISCELLANEOUS:
Carbon potentiometers 2K, 3K, 10K, 25K, 50K, 100K, 250K, 500K, 1 Meg, 2 Meg, all at 2/- each. Wire-wound potentiometers—all normal valves: 4-watt type, 3/- each; 2 1/2-watt type, 2/8 each. 5 mA bridge type instrument rectifier, 5/- each. Ceramic mounted 2-gang double-spaced variable condenser 34+34 pF. 81ze 1 1/2in. x 2in. x 4 1/2in. depth, 7/6. Metal rectifier 12 volt 11 amp. output, 4/-; Eveready & Vignoles bridge megger, complete with leather carrying case. Test voltage, 250 volts. New and unused, £33.
Business Hours: 9 a.m. - 5.30 p.m. Sats. 9 - 1 p.m.

LASKY'S RADIO SPECIAL OFFER EX-A.M. RADAR RECEIVER UNITS

Contains 17 valves.
 8 VR91 (Civilian Equivalent EF50)
 2 CV66 (" " " RL37)
 1 VU134 (" " " HVR2)
 1 VU39 (" " " R3)
 2 VR92 (" " " EA50)
 1 CV188 (Neon voltage stabiliser)
 1 VR137 (Civilian Equivalent EC62)
 1 VR507 (Spark Gap)

Dozens of components, condensers, resistances, valve-holders, coils, variable condensers, trimmers, co-axial connectors, toggle switches, transformers, etc., etc.

These receivers are absolutely brand new. In the makers original sealed cartons.

The chassis is totally enclosed in grey metal cabinet, size: 18in. long, 7 1/2in. deep, 8 1/2in. wide. Approximate weight 28 lbs. The complete receiver is packed in a wooden crate for safe transport.

Total weight when packed 40 lbs. approximately. Original cost of this equipment was well over £35.

LASKY'S PRICE 85/-

Carriage: England and Wales, 5/- extra; Scotland 6/-
 Send 1d. stamp for our current list of radio components, and other ex-Government bargains.

LASKY'S RADIO 370, Harrow Road, Paddington, W.9

Phone CU9Ninburnham 1979
 Hours: Mon. to Sat. 9 a.m. to 6 p.m. Thurs. half day

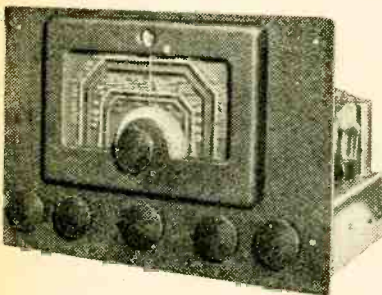

PEERLESS TYPE 1047 RADIO CHASSIS

This chassis is now available as an AC/DC model, and can also be supplied as a complete Radio Gramophone with twin speakers, acoustic labyrinth, etc., in walnut cabinet by one of Britain's leading designers.

Among its principal features are:—

- 10 stage superhet circuit.
- 10 valves (including magic eye).
- RF amplifier.
- 2 IF stages.
- 4 wave bands.
- 10 Watts push-pull output.
- Tropicalised components.

Communications enthusiasts should write for details of our 1946 Chassis.

PEERLESS RADIO LIMITED
 374, Kensington High St., LONDON, W.14
 Phone: WEstern 1221

G. A. RYALL, 65, Nightingale Lane, London, S.W.12. All other postal orders, extra, c.o.d. £1 or over, please send large envelope for our full list; U.S.A. make metal cased 500v tubular 0.1mf, 7/6 dozen; silver mica, 500pf, 300pf, 400pf, 500pf, 4/6 dozen; 500v wkg. micamou. led 0.004mf, 4/- dozen; mica 0.01mf, 3-2/-; Mansbridge 1mf 500v wkg. 3-3/-; 200pf condensers guaranteed; Amphenol type British 5 pin valve holders, 4/6 dozen; U.S.A. pax. lin 4-5-6-pin, 3/6 dozen; volume controls, 10,000 medium spindle, 1/6; 250,000ohm short spindle, 1/6; bar type 3-gang, 0.0004mf short spindle, 5/-; bar type 4-gang 0.0004mf, 5/-; resistors, 1/4 watt, 100ohms to 2meg. level assortment, 40-5-/-; plastic group boards, drilled, less tags, 9w types, 3-1/6; switches, SB, 2p 6w; miniature circular switches, 2/-; 3B 2p 6w 5p total, 2/6; 3B 3p 3w, 2/3; res. panels, 5w with 25mf 12v and 3 res., 1/3; 12-way group boards with 9-1watt and 1watt res., 2/-; all new; 20 types in stock; contact plugs, cap and socket, 3-2/6, with tags 3-3/-; high resistance phones with sponge earpads, with good class microphone, all wired into plug, rubber padded, plug type 10H/10991, 10/9 pair; metal boxes, black finish with 1/4in paxolin panels, 40-5-/-; and corner sockets, size 8 1/2 x 7 1/2 x 3 1/4 in deep, 6/9 each complete; international octal valve holders, paxolin chassis type, 46 dozen; metal-cased tubulars, 0.5mf, 350v, at 71d C. wire ends, 3-2/6; 15 reays in carrying rack, mounted, with cover, 42/6.

FREITH RADIOCRAFT, Ltd., the Leicester Specialists, offer from their comprehensive stocks: Bendix radio compass receivers, model MN26, 3 bands covering 150-325, 325-695, 695-1500 kc, 2 R.F. stages, with 12 metal valves and rotary converter for operation on 25v D.C.; Bendix receiver RA10, 4 bands covering 150-400, 400-1100 kc, 2-5, 5-10 mc. R.F. stage with 7 valves and rotary converter for 24v D.C.; price for either model £10, complete with full instructions for converting to A.C. operation; R.C.A. filament transformers, 210-230-250, 40-60 cycles, 2.5v 10a, 5v 20a, 10v 10a, all centre tapped, unrepeatable at £3; standard "U" channel steel racks (for 19in panels), 4ft 10in high, with base plates, £2; Jones plugs and sockets, 12-way, 5/- per pair; 20, 40 and 80m Eddystone 4-pin coils, 5/- set of 3; Wooden die luxe potted mains transformers, 300-0-300/120 ma, 6.3 and 5v, 250-0-250 notted output transformers, 7,000 CT, 3-15Ω sec, 25w, 29/6; potted smoothing chokes to match, 25/- set of 3, £4/10; tuning condensers, 160pf, 3-gang, ceramic insulation, Winrose & Rogers, 7/6; ditto .0005 3-gang, 7/6; meters, 3in flush type, 0-10 microamps (10,000/10), 21/-; 0-20v A.C., 12/6; 0-0-10 ma D.C., 12/6; 1-0-1 ma D.C., 12/6; 0-20a D.C., 5/-; 350-0-350 millivolts D.C., 15/-; 0-500 microamps D.C., 25/-; 2in square flush type 0-1 ma, 25/-; 50-0-50a, 7/6; 0-20v D.C., 12/6; 0-5a R.F., 7/6; 0-3a R.F., 7/6; bargain parcels, service type, multi-way plugs and sockets, 12 assorted, 5/-; Systoflex, 72 yards assorted, 5/-; new resistors and condensers, 25 assorted 5/6, 50 assorted 10/6, 100 assorted £1; satisfaction guaranteed or money refunded without question; latest lists free on request; trade supplied.

FREITH RADIOCRAFT, Ltd., Leicester. Tel. 58927. 19409

RDIO CLEARANCE, Ltd., 27, Tottenham Ct. Rd., London, W.1.—10-valve S.W. rec. RI481, range 65-86 m/cs, RF (VR65), OSO (VR66) mixer (VR65), 3 I.F.s (VR53's) det. and a.v.c. (EP34) A.F. (VR57), output (VR67), S.M. dial, B.F.O., tuning meter, R.F. and L.F. gain controls, require PP 250v HT 6.3v L.T., all brand new in wooden transit cases; as our previous lot, and we are now able to offer these sets which lend themselves readily to modification for 5 mtes., F.M., etc., at £7/19/6; circuit diagram supplied with each receiver, cartridge pair; meters, all moving coil, 0-1 ma, 2in square, 10/-; 0-10 ma 2in square, 9/6; 0-30 ma 2 1/2in circular, 8/6; 0-150 ma 2in square, 9/6; 0-200 ma 2 1/2in circular, 10/-; all the above are flush mounting; 750 micro amp 2 1/2in circular plug in calibrated 0-100 fcr use with thermo-couple as radiation meter, 8/6; Mansbridge condensers, 0.1 5,000v 5/6, 4 mf 1,000v 5/-, 10 mf 500v 5/6, 1 mf 1,000v 1/-, 2 mf 300v 10d, 0.25 mf 2,000v 1/9, 0.5 1,200v 1/-, all wkg. voltages; P.M. speakers, large magnets, all, speech coils, 5in less trans, 16/11, with trans, 19/11, 10in with trans, 37/6, all det. and hinged, 2 1/2in, 3 1/2in, 3 1/2in 170v 2/-, 4 mf 350v 2/6, 450v 2/9, 8 mf 450v 3/3, 8-8 450v 5/-, 8-24 350v 5/-, 16-24 350v 5/6, 16+32 350v 5/6, 16+16 350v 5/6, 16+8 450v 5/6, 25 mf 25v 2/-, 50 mf 12v 1/6, 100 mf 12v 1/-; vis. ind. ex-R.A.F. cross over needle, as used RI155, with 2 80 micro amp movements 5/11, 25 with 2 300 micro amp movements 4/-; panel mounting single fuse holders, 1/-; gang conds., single 0.0005 2/11, single 0.00015 2/3, 2-gang 0.0005 with epicyclic 10/6, 4-gang 0.0005 8/6, air spaced variables, 1/4 spindles, 30 p.f. 1/-, 50 p.f. 1/6, 75 p.f. 1/6; toggle switches, DP, ST, 2/-, DP, DT 2/11, DP, ST bakelite 1/6, SP, DT bakelite 1/6; volume controls with SW 2 1/2in spindle, 5K, 10K, 25K, 50K, 100K, 250K, 500K, 1M, 2M, 5/6; special 50K only with SW long spindle, 4/-; volume controls, carbon No. SW, 10K, 20K, 50K, 100K, 1M, 2/-; volume controls, wire wound, no SW, 200K, 500, 500K, 1K, 25K, 50K, 50K, 3v 1/6, 2/6; 15 watt 5000, 4/-; output trans, standard pentode 3/9, heavy duty 50-1 (5,000/20) 4/6; switches, 1P 9W 2/6, 1P 3W 1/9, 2P 4W 3/6 long spindle 3/6, 1P 10W 2B long spindle 3/6.

OPPORTUNITIES IN RADIO



Get this FREE Book!

"ENGINEERING OPPORTUNITIES"

reveals how you can become technically-qualified at home for a highly paid key-appointment in the vast Radio and Television Industry. In 100 pages of intensely interesting matter, it includes full details of our up-to-the-minute home study courses in all branches of RADIO and TELEVISION, A.M. Brit. I.R.E., A.M.I.E.E., City & Guilds, Special Television, Servicing, Sound Film Projection, Short Wave, High Frequency, and General Wireless Courses.

We Definitely Guarantee
 "NO PASS—NO FEE"

If you're earning less than £10 a week, this enlightening book is for you. Write for your copy today. It will be sent FREE and without obligation.

**BRITISH INSTITUTE OF
ENGINEERING TECHNOLOGY**
 388b, Shakespeare House,
 17/19, Stratford Place, London, W.1.



THIS USEFUL NEW FOLDER—

tells you all about the complete range of Henley SOLON Electric Soldering Irons, for the standard voltage ranges of 200/220 and 230/250; 65 watt and 125 watt models fitted with oval-tapered bits or pencil bits and 240 watt models fitted with oval-tapered bits are available.
 Write Today for the new folder ref. Y.10 describing

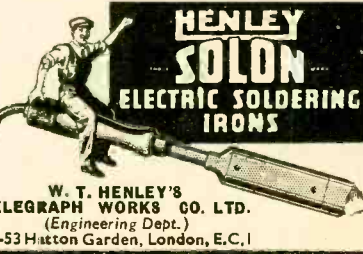

**HENLEY
SOLON
ELECTRIC SOLDERING
IRONS**
 W. T. HENLEY'S
 TELEGRAPH WORKS CO. LTD.
 (Engineering Dept.)
 51-53 Hutton Garden, London, E.C.1

CASTLE RADIO for new and up-to-date components; bring your set up to the modern standards by fitting a pair of Summersby Varitane selective I.F. transformers, high gain, litz wound, adjustable iron dust cores, bandwidth 6-12 kc/s, only 21/- pair; Summersby market tuning coils, very high gain, distretneformers, adjustable dust cores (as used by our pack manufacturers), 3/5 each; Wearite type adjustable auto-cored coils, 3/6 each; standard I.F.S. 15/- pair; I.F. filters, 3/- each; Output coil pack, a magnet pack with a high performance, 33/-; the Osmo; radio Heart, the easy way to build an efficient receiver. £5/16; the Albion coil pack, the pack built to a standard, 36/6; 2 gang, 0003, 10/-; 5-valve semi-conduct chassis, 4/-; walnut veneered cabinet for this chassis, 35/-; 2-speed drive, 2/6; epicyclic drive, 2/-; ceramic voltage droppers, 3 amp, 4 tappings, 5/-; dials, 5/-; pointers, speakers, line cord, etc.; write for latest list. Terms, c.w.o., plus 6d postage.—Castle Radio, 11, Mill Lane, Maccate, Kent. [19394]

WANTED, EXCHANGE, ETC.
WANTED. A.R.88 service manual, state price.—Box 5530. [92324]

RADIOGRAM or television cabinet, dimensions, price.—Box 5665. [92399]

WANTED, AR88 or similar receiver, good condition.—9, Leander Rd., Rochester. [92399]

CATHODE ray tubes, 9in and 12in, magnetic, wanted.—Day, 36, Vivian Ave., Wemoley. [92399]

WANTED, Lako 1vn, TA201 Svc. Shts.; £1 pd.—4, New Zealand Av., Walton-on-Thames. [92399]

MAGNAVOX 44, 2,500 field, energised speaker. Prendergast, 14, Ventham St., Lewisham, S.E.13. [92399]

COLVER Ferrocoil coil, G3, without switch.—Tedman, Corner Cottage, Offchurch, Leamington Spa. [9230]

RECORD changing unit urgently required for fitting into radiogram cabinet; well-known brand make preferred.—Box 5534. [92346]

EX-SERVICE valves wanted, equiv. to E239, E236 and E232, any quantity; all letters answered.—N. R. S., 66, Parkhill Rd., London, N.W.3. [9034]

WANTED, in good condition, dozen Ferranti resistance holders for 2½-watt cartridge type.—Offers to McEwan, 70, London Rd., Slough, Berks. [9108]

WANTED, Douglas No. 3 or similar coil winding machine, in first-class condition only.—Thermionic Products, Ltd., Pratt Walk, Lambeth, S.E.11. [9242]

V.G. 78 33½ motor required, with or without tracking gear; will pay exceptionally good price.—Write BGM/KATHERINE c/o 3, Bloomsbury St., W.C.1. [9216]

SMALL 28v U.S.A. aircraft fittings, type SCBY 46104 with M/gen., offer £6; also Universal-stop mechanisms from 1154 T.X. offer 15/- each (one).—Crampin, Grimsby. [9216]

REPAIRS AND SERVICE
Mains transformers rewound, new transformers to any specification.
Motor rewinds, complete overhauls; first-class workmanship, fully guaranteed.
F.M. ELECTRIC Co., Ltd., Potters Bldgs., Warser Gate, Nottingham. Est. 1917. Tel. 3955.

Mains transformer rewound and constructed to any specification; prompt delivery.—Brown, 3, Burrows, Bradford. [9460]

Loudspeaker repairs, British, American, any make, moderate prices.—Sinclair Speakers, 12, Pembroke St., London, N.1. Terminus 4355. [3508]

TEST instrument repairs. Electrical test instruments repaired and recalibrated. Quick service, guaranteed work. Avo a speciality.—Electrico, 99, George St., Croydon. [8698]

Loudspeakers repaired; transformers, cock coils, chokes, rewound; prompt attention; prices quoted.—E. Mason, 5, Balham Grove, Balham, London, S.W. [7667]

REWINDS and conversions to mains and output transformers, from 4/6; pp equipment a speciality.—N.L. Rewinds, 4, Brecknock Rd., N.7. Tel. Arcoult 3390. [6283]

ELECTRICAL measuring instruments skilfully repaired and recalibrated.—Electrical Instrument Repair Service, 329, Kilburn Lane, London, W.9. Tel. Lad. 4168. [6935]

REWIND service which duplicates or modifies as required; transformers, loudspeakers, etc.; prompt returns.—Raidel Services, 49, Lr. Addiscombe Rd., Croydon, Cro. 6537.

SECOND to none.—Rewinds to mains transformers, gram motors, pick-ups, armatures, electric clocks, etc.; guaranteed satisfaction; trade invited.—Laycock Bros., 36, St. Stephen's Rd., Manchester Rd., Bradford. [9477]

REWINDING of all types of transformers, R chokes, etc.; quick service; motor rewinds of all types; replacement bobbin supplied; new transformers to any specification.—Radio & Transformer Services, 570, Manchester Rd., Hollinwood, Lancs. [8638]

LOUDSPEAKER repairs, any make, reasonable prices, prompt delivery, to the trade and quality fairs; 25 years' combined experience with Rola, Magnavox, Gemson, Goodmans.—Sound Service Radios, 80, Richmond Rd., Kingston-on-Thames, Kin. 8008. [4977]

NATIONAL RADIO SERVICE & TELEVISION Co.—Trade service engineers; immediate service any district; rewinds to all types transformers, armatures, motors, loudspeaker cones, speech coils fitted, British and American components, and all enquiries invited for contract trade service; multiple transformer winding.—63, High St., St. John's Wood, N.W.8. Primrose 6725. [6752]

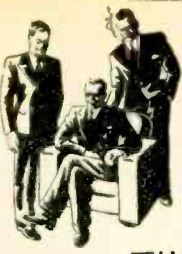

"Beautiful!"
"Satisfying!"
"Unconventional!"

THAT'S what they say about this satisfying new Extension Speaker, the

"BAFFLETTE"

by
Richard Allan

Remarkable fidelity due to unique design—different from resonant "box" types. Streamlined Cabinet, precision-built interior.



Regd. Design No. 831509

Experts agree a baffle type is best. Hear the "BAFFLETTE" and give us your opinion! Reputable Retailers have it.

RETAIL PRICE (Walnut veneer)
4 Gns.
Mahogany £4. 10. 0
EXPORT ENQUIRIES INVITED.

RICHARD ALLAN
RADIO LTD.,
CALEDONIAN ROAD, BATLEY, YORKS.
Tel. Batley 1123. 'Grams: Acoustics, batley.

MORSE CODE TRAINING



There are Candler Morse Code Courses for BEGINNERS AND OPERATORS.

Send for this Free "BOOK OF FACTS" It gives full details concerning all Courses.

THE CANDLER SYSTEM CO.,
Room 55W, 121 Kingsway, London, W.C.2
Candler System Co., Denver, Colorado, U.S.A.

"SERVICE with a Smile."—Repairers of all types of British and American receivers; coil rewinds; American valves, spares, line cord.—F.R.I., Ltd., 22, Howland St., W.1. Museum 5675. [1575]

STURDY rewinds, mains transformers, chokes and fields; we give prompt delivery and guarantee satisfaction; 14 years' experience; prices on request.—Sturdy Electric Co., Ltd., Dupton, Newcastle-on-Tyne. [5716]

REPAIRS to moving coil speakers, cones, cones fitted, field rewound or altered; speaker transformers, cock coils rewound; guaranteed satisfaction, prompt service; no mains trans. accepted. Coesed sat.
L.S. REPAIR SERVICE, 49, Trinity Rd., Upper Tooting, London, S.W.17. Baham 2359.

COIL specialists.—Tuning and oscillator coils, I.F., L.F. and mains transformers rewound and wound to specification; wavewinding, L.S. repairs.—Electronic Services (R.T.R.A.), 17, Arwenack St., Plymouth, Cornwall; and 49, Uxbridge Rd., Ealing, W.5.

REWINDS, mains transformers, speaker field coil, chokes, high-grade workmanship, 7 day delivery; new transformers constructed to customers specification, singly or in quantities.—Metropolitan Radio Electric Co., 1021, Finchley Rd., N.W.11. Speedwell, 3000 [5719]

24-HOUR service, 6 months' guarantee; any transformer rewound, mains outputs and I.F.s., etc.; all types of new transf., etc., supplied to specification; business heading or service card for trade prices.—Majestic Winding Co., 180, Windham Rd., Bournemouth.

LOUDSPEAKER and transformer repairs "almost by return of post"; we offer the quickest service in the trade, at competitive prices. Send 1d for our monthly service bulletin. Dept. W.—A.W.F. Radio Products, Ltd., Borough Mills, Bradford, Yorks. Tel. 22538.

TRANSFORMERS, chokes, coils, etc., rewound and manufactured to order, single or quantity; qualified consulting engineers available to help solve your problems; light engineering, turning, spot-welding, pressing; enquiries for contract work invited.—Millett & Hoden, Ltd., 2, Pembury Rd., Westcliff-on-Sea, Essex. [5992]

REWINDS—Armatures, fields, transformers, R pick-ups, vacuum cleaners, gram, motor, speakers refitted new cones and speech coils, all guaranteed and promptly executed. New vacuum cleaners, most popular makes, send stamped addressed envelope for list of radio spares and c.o.d. service.—A.D.S. Co., 261-3-5, Lichfield Rd., Aston, Birmingham, 6. [8238]

MISCELLANEOUS

W.W., Sept., '43, to Dec. '47; what offers?—Write Box 5046. [9100]

W.W. Jan., '46, to Dec., '47; offers.—Steel 154, Huntingdon Rd., York. [9123]

SPEECH disability; Mr. H. V. Hemery consults at Wigmore Hall Studios, W.1. [9123]

W.W. Jan., '46 to Dec., '47; 27/6; s.a.e.—Hobson, 31, Ennerdale, Birkenhead. [9123]

5381b of 26 gauge copper cotton-covered wire for disposal; can be split into small lots.—Box 5523. [9215]

FOR sale, "Wireless World," unbound, 1927 F to 1938, complete.—Offers to Eldred, Caenlochan Rd., Broughty Ferry, Angus. [9127]

50000 sq yd electric heating gauze for disposal, large or small quantities; samples on request.—Box 5021. [9074]

SWITCH cleaner, Lanoil 10% attiline dye and Trichlorethylene, 18/- doz, sample 2/-, c.w.o.—Sussex Laboratories, Ltd., Ferring, Sussex. [3271]

PERSPEX windows for W.V. television, telescope, size 10in by 8in, carriage paid, 9/6, c.w.o.; other sizes by specification.—Blacks Industries, Ltd., 13 Chalon St., N.W.1. Euston 6254.

RADIO; 5/- only; 20,000 pairs ex-govt. phones, new and unused, postage and packing 1/- extra.—Electron (Lndon), Ltd., 31, Curzon St., London, W.1. Tel. Grosvenor 1993.

ALUMINIUM chassis and panels, any size, plain or punched to your requirements; from 3/9; sample sizes 18 swg 6x4x2, 3/9, 10x6x2, 4/6.—Mead, 13, Bence Lane, Darton, Barnsley.

CIRCUIT diagrams (individual designs) to order; chassis layouts suggested, data and technical advice for radio enthusiasts; special attention by correspondence.—Write, R. G. Youns, 3a, Bridges Rd., Wembleton.

SPARKS data sheets provide complete construction details and full-size draughtsmen prepared prints showing drilling, assembly and wiring plans of tested and guaranteed designs by L. Ormond Sparks.

LATEST release.—The Challenger portable ac/dc 3-valve (plus rect.) T.R.F. circuit having an exceptional performance on med. and long waves, the ideal set for radio in any room, no aerial or earth; 6in Stentorian speaker gives amazing power and quality; no complicated switching or adjustments; data sheet 2/9.

COMPONENTS can now be supplied; send a stamp for list giving full details of 34 designs available.

SPARKS' DATA SHEETS (W), 9, Phoebe Rd., Brockley, S.E.4. Tel. Lee Green 0220.

TELEVISION TRF sound receiver units, HF and det., 7 valves, 14in X-in, 14in, 14in, for driving C.P. stage tested on AP before despatch, 27; vision ditto; Bakelite-Paxolin, etc., wide variety, useful for workshop, pp lb 3/6. 5lb sample parcel 12/6 post free; useful metal box unit containing 2 SP.61s (VR65), 10/-.—Television Development Co., 4, The Parade, High Rd., Kilburn, N.W.6. Mal. 3591. [9420]

MIDLAND INSTRUMENT CO.

OFFER GOVT. SURPLUS STOCK

AMERICAN AN/AP1 CATHODE RAY UNITS, 11 valve amplifier power pack, 34in. C.R. tube, control unit, etc., with instructional booklet and data to use from 230-v. A.C., brand new in sealed cartons, £5, carriage paid. **ELIMINATORS**, A.C. input 200/250-v. D.C. output 120-v. 30-mA., fitted neon stabilizer. brand new, 40/- **MOTORS** fitted centrifugal pump 12/24-v. A.C./D.C. for liquids, brand new, 35/- **MOTORS**, 12-v. A.C./D.C. takes 4-amp., fitted gear-box, powerful final drive 1,000-r.p.m., 25/- **POST 1/4 MAINS MOTORS**, 200/250-v. A.C./D.C. takes approx. 1-amp. (converted motor generators) fitted 1in. shaft, 30/- **GENERATORS** (D.C. dynamos) output 12-v. 750-watt, 30/- carriage 5/-, also 24-v. 1,000-watt output, 40/-, carriage 10/-extra. **1155 RECEIVER** twin-knob slow-motion drives, 210-1, brand new, 5/-, post 9d. **B.T.H. CRYSTAL VALVE RECTIFIERS** C87-A, brand new in lead capsules, 8/6, post 3d. **BROWN'S 4,000-ohm HEADPHONES**, brand new 10/-, post 9d. **CLOCKS**, aircraft dashboard mtg. luminous, rim wind, trip hand set, 2 1/2in. dia., 1,000-watt boxed, 70/-, post paid. **G.P.O. TYPE RELAYS** 1,000-ohm, single make, 1/-, 10/- doz. **U.S. ARMY BLASTING MACHINES** (10-cap), a very neat hand type A.C. generator, worth £10, brand new boxed, 25/-, post 1/4. **PLUGS** with lugs to fit, 2-way, 1 1/2, 4-way, 2/6. **JONES 6-WAY PLUGS** with sockets to fit, 2/6. **MICROPHONES**, carbon type, 12in. etc., etc. bakelite case fitted switch, brand new, 2/6. 24/- doz. **OXYGEN FLOW INDICATORS**, brand new boxed 1/6. **MAGNETIC COMPASS** variation correctors 1/6. **D.E. COMPASS** accessories, variation correctors 15/- pilots repeater compasses, 15/- **CAMERA CONTROLS**, 12-v., contains motor, clockwork escapement, 1-50 sec. timing device, counter 0-120, etc., etc. brand new in wood cases, 25/-, post 1/4. Also hundred of other interesting Radio, Electronic and Mechanic items to offer, send for our current lists, 2d. with s.a.e. Orders over 30/- post paid, carriage extra. Note increase in postage rates. No C.O.D. under 20/-.

Moorpool Circle, Birmingham, 17

Tel.: HARborne 1308 or 2664



BATTERY CHARGERS AND TRICKLE CHARGERS

Trouble-free Chargers fitted with selenium all-metal rectification. Deferred terms arranged, and good allowance on old models. Thirty years experience behind every Runbaken product. Booklet R.15 describing 12 Models, on request.

RUNBAKEN-MANCHESTER LTD.

HILL & CHURCHILL LTD. BOOKSELLERS

SWANAGE, DORSET

Available from Stock:

- Terman, "Radio Engineers' Handbook" 42/-
- Terman, "Measurements in Radio Engineering" 27/-
- Scheikunoff, "Electro Magnetic Waves" 37/6
- Zworykin and others, "Electron Optics and the Electron Microscope" 60/-
- Sandeman, "Radio Engineering," Vol. I 45/-
- Hall, "Radar Aids to Navigation" 30/-
- Harvey, "High Frequency Thermionic Tubes" 18/-
- Knight, "Fundamentals of Radar" 10/-

Postage extra.

CATALOGUE ON APPLICATION

COPPER and resistance wire, silk, rayon, cotton and asbestos covered, 15 to 46 swg; Litz wire, 27/42, 27/44 and 27/46; 10 tons in stock at 10% under market price.—C. Leatherbarrow, Ltd., Grand Bldgs. W.C.2. Whitehall 5948.

WAVE-WINDING machines, a simple, compact, yet efficient machine, with minimum of gears, capable of half or full wave windings, of under 1/4in to over 1/2in width, on all standard formers; now going into production; trade and export enquiries invited; write for details now.

G.W.B., 80, Farnfield Drive, S.W.18. **ALWAYS** sure of a good reception: "Radio Craft," 21/6; "C.Q.," 18/6; "Radio News," 25/-; "Q.S.T.," 21/6; "Life" (International), 40/-; "Look," 25/-; "Saturday Ev. Post," 55/-, etc.—For full list of all other American magazines send s.a.e. to Willen Ltd. (Dept. 52), 120, St. George's Rd., London E.10. (9206)

JUNCTION electric irons, complete with stand, switch connector and flex, again available; very prompt deliveries; beautifully chromium-plated; the finest electric iron of its kind in the world; a.c. d.c., in all voltages; with rich range of other household electrical appliances.—Distributors: Brooks & Bohm, Ltd., 90, Victoria St., London, S.W.1. (9203)

WORK WANTED

ELECTRONIC development. **OUR** laboratories and drawing office, devoted to the design and construction of complex electronic, electrical and electro-mechanical devices, have some capacity available for design and development of specialized equipment; capacity is also available for the building of prototypes and the small scale production of new designs; the service is also available to manufacturers requiring data and test reports on their own products. Becomin Laboratories, Becomin Ltd., Langman, Ltd., Gads Hill, Gillingham, Kent. Tel. Gillingham 59095. (9266)

INSTRUMENT gear cutting capacity.—Lloyd & Ramsden, Huntingdon St., Nottingham.

WAVE winding capacity available; your models copied or new types developed to your specification.—Box 5044. (887)

FACTORY has technical staff and capacity available for manufacturing scientific or other articles in glass.—Box 4462. (8853)

WE make wireless and radiogram cabinets for home and export; immediate deliveries.—Radio, Ltd., 26, Bredensbury Rd., London, N.W.6. Maid, Vale 8792.

IMMEDIATE capacity for finest toolmaking, hand and power presswork, machining, assembling, plating, etc., complete manufacturing undertaken.—Box 5545. (9275)

DRAWING and tracing work for radio and electrical engineering, jig and tool and night engineering, photoprinting; full sets of drawings undertaken to commercial or Ministry standards.—Drawing & Tracing, Ltd., 456a, Ewell Rd., Tolworth, Surbiton. Tel. Elmbridge 7406. (7703)

WIRELESS—Contracts, sub-contracts, etc., read for assembly, wiring, test, of radio sets, amplifiers, electronic instruments, etc.; fully experienced men; good facilities for design and calibration; if required, immediate capacity, excellent references.—Letters only to Television & Radio (Rebuildings), Ltd., 142, West End Lane, N.W.6. (9147)

YOUR product can be in production in next 24 hours; we have facilities for radio and electrical assembly and test, and associated sheet and strip metal work, brazing, oxy and electric welding, cellulose and stoving, and presswork; good stocks of steel, plywood, etc.; specialists in sub-contracts, we can save you time, money and headaches.—Box 4378. (9053)

RESEARCH engineers with well equipped electrical and mechanical laboratories and drawing office, are prepared to undertake the design and/or fabrication of special scientific and industrial equipment; the organisation is suited to the design or research on the industrial electronic and other fields, also the design and construction of specialised and ancillary apparatus.—Box 3525. (8559)

LARGE firm of woodworkers are developing 1 1/2 mils. machining, veneering, assembly and finishing shops; for specialised production, these shops will be controlled by men of long technical and practical experience; these services will be available shortly, and we invite enquiries from firms of good standing or their accredited agents; the plant is most modern and capable of fabrication of a high-class production; technical service available to prospective clients immediately.—Box 2594. (8325)

BUSINESSES FOR SALE OR WANTED

ELECTRICAL manufacturing business (transformers, etc.) in South London for sale by Receiver, price £1,000 or offer.—For particulars apply, Box 5538. (9258)

WELL-ESTABLISHED radio electrical business, modern freehold d.f. shop, house, large garage; good garden; turnover £6,000 and rising; leading agencies with good allocations; ample scope with no opposition, large West Country village, new cinema; offers around £7,500, s.a.v.—Box 5698. (9367)

RADIO electrical lock-up shop, modern block, Sutton (Surrey), attractive frontage, two windows, equipped television aerial, charging plant; very low overheads, considerable scope for expansion, favourable lease; price £250, plus stock at valuation (about £250)—Apply N. J. S. 68, Parkhill Rd., London, N.W.3. Gulliver 1453.

COMMUNICATIONS RECEIVER BC.348.R. The famous American Air Force's 8 valve superhet receiver covering 500-200 kcs. and 1.5-18.0 mcs. in six bands. As advertised last month, when full specification was given. **ALL BRAND NEW IN SEALED MANUFACTURER'S CART NS. ONLY 28/10.** Carriage, etc. 10/-. **COMPLETE WITH POWER PACK** for 220-250 v. A.C. input 28 v. D.C. output, which will operate the built-in Dynamotor in the receiver.

COMMUNICATIONS RECEIVER R.1224.A. The ex-R.A.F. 8 valve superhet battery receiver covering 1.0-10.0 mcs. in 3 switchable bands. Power supply 2 v. L.T., 9 v. G.B., 120 v. H.T. Has multiband precision slow motion dial, aerial trimmer, sensitivity control, etc. Circuit employs R.F. stage. Supplied with valves as follows: 2 type VP23 and 1 each PC2A, HL2, RT2. Cabinet size 16in. x 9 1/2in. x 8 1/2in. **ALL BRAND NEW IN ORIGINAL PACKING. ONLY 99/6.** (Carriage etc./7/6).

AMERICAN FREQUENCY METERS BC.221. Frequency coverage 125-20,000 kcs. Contains crystal controlled oscillator, heterodyne oscillator, and an audio frequency amplifier. Complete with two valves type 6X17 and one type 6X8, and Xtal. Instruction book with calibrated charts with each instrument. Designed for battery operation 6 v. L.T. and 130 v. H.T., but ample space in battery compartment for mains power pack. **BRAND NEW AND COMPLETE WITH CANVAS CARRIER. ONLY £15.** (Carriage, etc./10/-).

AMPLIFIERS. Another purchase of the very fine ex-R.A.F. Battery Amplifier we offered a few months ago. Ideal for use with gram, pick-up or for a home intercommunication set, etc. Complete with valves type 6P21 and 2101F. Power supply required 2 v. L.T. and 120 v. H.T. Supplied in wood trunk case. **BRAND NEW. Only 25/-.** (Carriage, etc./2/6).

C.W.O. please. S.A.E. brings current lists.

THE RADIO CORNER

138, GRAY'S INN ROAD, LONDON, W.C.1

Phone: TERminus 7937.

Open until 1 p.m. Saturdays, we are 2 mins. from High Holborn, 5 mins. from King's X.

IN SPITE OF DIFFICULTIES SERVICE ON LOUSPEAKERS IS BEING MAINTAINED.



VOIGT PATENTS LTD.

QUARTZ CRYSTAL UNITS

FOR AMATEURS

for your **TRANSMITTER**

HIGHER ACCURACY

COMPETITIVE PRICES

Delivery **FROM STOCK**

For your **FREQUENCY STANDARD**

SALFORD ELECTRICAL INSTRUMENTS LTD.

PEEL WORKS, SALFORD 3

Proprietors: THE GENERAL ELECTRIC Co. Ltd., of England

RADIO and electrical business for sale. N.W. London; price, including fittings and fixtures, etc., £400, plus s.a.v.; turnover approx. £500; legitimate reason for selling; snip. Box 5752. [9404]

VEST Country, county town, very fine and well-established radio shop and radio engineering business, small flat, fully equipped workshops and benches, large turnover, audited accounts; business equipment and leases for let as a going concern; very strongly recommended.—Apply, Jackson-Stops & Staff, Yeovil.

COMPREHENSIVELY equipped and well-established radio and electrical transformer and coil winding business for disposal as a going concern; suitable connections throughout the country; situated prominent position in S.E. London suburb; price £4,000, including plant and fittings; s.a.v.; details in confidence to principals only.—Write Box 4392, Post-Smith Advcs., 64, Finsbury Pavement, London, E.C.2. [19079]

BUSINESS OPPORTUNITIES

TECHNICAL writer, electronic engineers seek contact with writer able to assist in preparation of sales, literature.—Box 5528. [9226]

WHIZARDS of Baker St. and Hampstead, exhibiting at the Ideal Home Exhibition, March 2nd-25th, Empire Hall, Stands 414 and 5, invite manufacturers or factors to send writing orders of any radio, television or domestic electrical appliances suitable for display or sale. To be acceptable they must be unique or advanced design.—Write Bernard Kennedy, Whizzards, 136, Baker St., W.1.

RADIO domestic receivers, company manufacturing, amongst other products, domestic receiving sets, has for disposal licensed production for current licence year and for export, substantial quantities involved, also stocks of components and supplies available; by manufacturer or organization with large resources for marketing are invited to communicate with Box M.722, c/o Jacksons, 16, Racechurch St., E.C.3. [19252]

SITUATIONS VACANT

Vacancies advertised are restricted to persons for employment excepted from the provisions of the Control of Employment Order 1947.

RAMATUBE winder and stator winder for a small firm with good contacts; exceptionally good prospects for young man with ambition.—Box 5551. [92825]

RADIO service engineers urgently required by Burncup, Ltd., Erith, Kent; experience essential; wage, stating age, experience and salary required.—Box 5540. [19266]

APPPLICATIONS are invited from candidates with experience in the following categories or appointment in the Middle East Communications Establishment of large oil company:

- a) Assistant communications engineer; telephone, telegraph equipment, including open-wire lines, cables, auto and C.B. exchange and teleprinters; age limit 34; salary not less than £500 a.—Replies quoting PLO293.
- b) Carrier-telephone room attendant; sound fundamental knowledge with experience in carrier-telephony, V.F. repeater stations and allied problems; ability to read schematics; age limit 28; salary £360 p.a.—Replies quoting L0294.
- c) Wireless officers, qualified to standard certificate by possession of first-class P.M.G. certificate for sea-going duties, or equivalent and competence in installation/maintenance, age limit 34; salary for first three-year contract, £260 p.a.—Replies quoting PLO341.

LL appointments carry additional benefit of free quarters, messing and allowances between the range of £195-£400 yearly, dependant on family circumstances; the service is pensionable, non-contributory; married applicants must be prepared to live singly for first three years overseas.—Write to Box 2045 B.E., c/o Charles Barker & Sons, Ltd., 31, Budge Row, London, E.C.4. [9189]

DRAUGHTSMEN for radio and television design required by E.M.I. Engineering Development, Ltd.—Apply in person, or write to Personnel Dept., E.M.I., Ltd., Blyth Rd., Hayes, Middx. [9379]

SENIOR engineer required for design and development equipment with a rapidly expanding manufacture.—Write, giving full particulars and experience, to G. E. R. C., 92, Charlotte St., W.1. [9380]

DRAUGHTSMEN required for radar telecommunications and electro-mechanical instruments, West London area.—Apply in confidence, stating age, details of experience, and salary required, to Box 5532. [9240]

DESIGNER-DRAUGHTSMAN required for factory, Northern area, must be conversant with Radar and radio equipment construction.—Reply, stating age, full details of experience, training and salary required to Box 5548. [9279]

JUNIOR laboratory assistant, 20-22, with some knowledge of chemistry. Preferably up to Inter-B.Sc. standard, for raw material and process testing.—Write, giving details of experience, age, etc., to A. H. Hunt, Ltd., Bendon Valley, S.W.18. [8353]

SENIOR engineer to take charge laboratory developments, commercial radio and television receivers, London.—Apply, giving experience and age, to Box No. 773, The Engineering Co., Ltd., Ludgate House 107, Fleet St., London, E.C.4. [19208]

BAKERS 'Selhurst' RADIO HIGH FIDELITY SPEAKERS

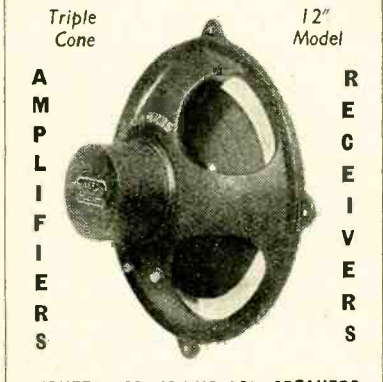

PIONEERS OF MOVING COIL SPEAKERS

NEW 1948 MODELS
CINEMA MODEL, 18 inch - - £9 19 6
AUDITORIUM MODEL, 12 inch - \$6 10 0

Bend 2/3d. stamp for illustrated list to:
BAKERS 'SELHURST' RADIO
 75-77, Sussex Road, South Crondon, Surrey
 Telephone: CROUDN 4226.

POTENTIOMETERS

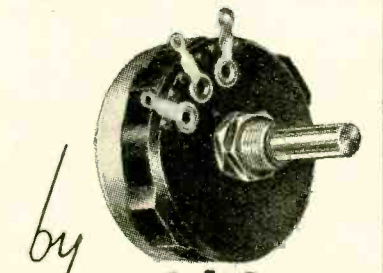

RELIANCE

| Type T.W. Wire Wound | |
|-----------------------|----------------------------|
| Rating | RANGES |
| 5 Watts Max. (linear) | 10-100,000 Ω Max. (linear) |
| (linear) | 100-50,000 Ω Max. (graded) |
| 3 Watts Max. (graded) | 100-10,000 Ω Non-inductive |
| Type S.G. Composition | |
| 1 Watt Max. | 2,000 ohms to 2 megohms |

CHARACTERISTICS: (both types) linear, log., semi-log., inverse log., non-inductive, etc.

FULL DATA FROM:
RELIANCE
 Manufacturing Co. (Southwark) Ltd.,
 Sutherland Rd., Higham Hill, London, E.17.
 Telephone: Larkswood 3245

JUNIOR laboratory assistant with some knowledge of physics and some electrical training.—Write, giving details of experience, age, etc., to A. H. Hunt, Ltd., Bendon Valley, S.W.18. [8353]

L to present staff) to carry out research and development work.—Apply in writing, giving full details of experience, education, age, salary required: Goodmans Industries, Ltd., Lancelotti Rd., Wembley, Middx. [9232]

A opportunity is now open for an engineer with first-class experience in designing radio and electrical equipment to join company as chief engineer; excellent prospects for a man with the right experience, initiative and organising ability.—Write to Box 5084. [9141]

SENIOR draughtsman required for company manufacturing radio and electrical equipment; good salary, prospects, and 5-day week.—Write, giving full details of experience and salary required, to Taylor Electrical Instruments, Ltd., Montrose Ave., Slough, Bucks. [9139]

DEVELOPMENT engineer required West London area, must have industrial experience preferably of audio frequency amplifiers, and education to at least Inter B.Sc. standard.—Write, stating age, experience, education and salary required, to Box 5533. [9243]

RADIO engineer required for technical investigation work on large scale radio receiver and component production; education up to Higher National Certificate or Guilds' final. Apply by letter to Personnel Dept., A.T. E. I. Factories, Ltd., Blyth Rd., Hayes, Middx. [9239]

LEADING Company requires junior development engineer (inter B.Sc. standard), preferably with experience in radar or communications work; commencing salary between £350 and £400 (according to experience), with excellent prospects for advancement.—Box 4967.

DEVELOPMENT engineers required by radio manufacturers in Essex for work on centimetric waves; candidates should possess a University degree preferably with telecommunication as a subject, age 25-35; salary according to age and experience.—App to Box 5546, quoting Ref. 91. [19276]

LEADING radio company requires the services of a fully qualified and experienced communications engineer as chief engineer in charge of domestic radio and television research and development; salary £1,200-£1,500 per annum, not less than 35 years.—State full details of experience to Box 5527. [19224]

WANTED, young electrical engineer with good qualifications and experience, to take charge of new industrial induction heating plant in Midlands; salary £500-£750 p.a., according to ability.—Apply in writing, Director of Research, G.K.N. Research Laboratories, Manor Works, Ettingshall, Wolverhampton. [9219]

ASSISTANT sales engineer, age 23-27 years, required by capacitor sales division of telecommunications engineering company; applications, stating age, existing experience, etc., should be confined to those prepared to reside in a ready resident in S.E. London area.—Write Box N5525, A.K. Advcs., 212a, Shaftesbury Ave., W.C.2. [19227]

FERGUSON RADIO CORPORATION requires a junior engineer for television receiver development; candidates preferred with a 4000 engineering degree or H.N.C. in electrical engineering; salary according to qualifications and experience.—Apply Personnel Officer, Ferguson Radio Corp., Ltd., Gt. Cambridge Rd., Enfield, Middx. [9184]

ACOUSTICAL MFG. Co., Ltd., invite applications for the post of assistant development engineer; thorough knowledge of electrical frequency amplification and electro-acoustic principles essential; experience in acoustic measurement an advantage; particulars of age, training, experience, etc., to Acoustical Mfg. Co., Ltd., Huntingdon. [9266]

MANUFACTURERS of wireless equipment in South-East England require immediately two experienced estimators.—Applicants with workshop and/or drawing office experience on light electrical equipment with previous estimating experience, should apply, stating age, qualifications, experience and salary expected, quoting Ref. 89 to Box 5526. [9222]

SENIOR design engineer required by provincial radio manufacturer opening new laboratory in London area; extensive laboratory experience in design and development of radio and television receivers essential; able to train and encourage junior staff; good salary and prospects.—Reply to Box 5535, stating age, qualifications, experience and salary required. [9251]

FERGUSON RADIO CORPORATION requires a technical assistant in the vacuum tube department; candidates should hold a degree in engineering or physics, and have a good knowledge of glass technology; salary according to qualifications and experience.—Apply Personnel Officer, Ferguson Radio Corporation, Gt. Cambridge Rd., Enfield, Middx. [9186]

An instructor in radio repairing is required for Hounslow Government Training Centre; applicants must have had at least 5 years' experience in radio servicing and should hold a City and Guilds Certificate in Telecommunications or Radio Service Work; initial inclusive annual salary is £405; provision is made for annual increases of salary of £10 to a max. of £440 per annum; annual and sick leave with pay, subject to Civil Service conditions.—Applications should be made in writing to the Regional Controller, Ministry of Labour and National Service (Room 222), Hanway House, Red Lion Square, W.C.1.

100 kcs.
QUARTZ
CRYSTAL
UNIT
Type
Q5/100



for Secondary Frequency Standards

★ Accuracy better than 0.01%. ★ New angles of cut give a temperature coefficient of 2 parts in a million per degree Centigrade temperature change. ★ Vitreous silver electrodes fired direct on to the faces of the crystal itself, giving permanence of calibration. ★ Simple single valve circuit gives strong harmonics at 100 kcs. intervals up to 20 Mcs. ★ Octal based mount of compact dimensions.

Full details of the Q5/100, including circuit are contained in our leaflet Q1. Send stamp to-day for your copy

THE QUARTZ CRYSTAL Co., Ltd.
63-71 Kingston Road,
NEW MALDEN, SURREY
Telephone: MALden 0334

"PERIMET" ELECTRODE
Soldering and Brazing Tool

Operates from 4 or 6 Volt Accumulator or Transformer.



15s. Post free

MAINS TRANSFORMER, 3 Heats. 35s. Post free.
HOLBORNER & CO.,
71, Weymouth Bay Avenue, Weymouth.

TELEVISION

The advance in Radio Technique offers unlimited opportunities of high pay and secure posts for those Radio Engineers who have had the foresight to become technically qualified. How you can do this quickly and easily in your spare time is fully explained in our unique handbook "Engineering Opportunities." Full details are given of A.M.I.E.E., A.M.Brit.I.E.E., City & Guilds Exams., and particulars of up-to-date courses in Wireless Engineering, Radio Servicing, Short Waves, Television, Mathematics, etc., etc.

We Guarantee "NO PASS—NO FEE"

Prepare for to-morrow's opportunities and future competition by sending for your copy of this very informative 112-page guide NOW—FREE.

BRITISH INSTITUTE OF ENGINEERING TECHNOLOGY (Dept. 388)
17, 8 Ratford Place, London, W.1

EDDYSTONE

'504' '640' '680'

and

Full range of S.W. components.

Also

Valves, condensers, transformers, resistances, etc.

All C.O.D. orders promptly executed. 52 page catalogue 1/- post free.

B.T.S.

THE Radio firm of the South.

63, London Road, Brighton, 1, Sussex.
Phone Brighton 1555.

CORRESPONDENCE clerk required for service department of large radio manufacturers in North London; applicants should have education at least to School Certificate standard, and some technical training, and should give full particulars of age, experience and salary required; to: Box No. 275, c/o Era Publicity, Ltd., 166, Camden High St., London, N.W.1. [9194]

WANTED, an instructor to teach the radio trade to disabled boys, ages 15-18 yrs., at the Lord Mayor Trust, Grays, Col. Leg. Alton Hants; commercial experience essential; commencing salary £375 per annum.—Applications with copies of two testimonials or the names of two persons to whom reference may be made, to be sent to the Secretary as soon as possible.

ENGINEER, aged 25-30, to train as a specialist in the suppression of electric interference with radio communication broadcast or television must hold not less than City and Guilds Radio Communications Grade III and preferably Grad. I.E.E. or A.M.I.E.E.; must run own car, business car expenses paid; applications to state age, experience and salary required. —Box 539.

FERGUSON RADIO CORPORATION requires a junior representative for television servicing and supervising installation of receivers; own car an advantage; good technical knowledge and good address essential; remuneration according to experience and qualification. —Box 539.

ENGINEERS required for employment on development of Radar, communication and electronic equipment; applicants must possess a degree in engineering or its equivalent; salary £400 to £600 per annum according to qualifications.—Reply, stating age, experience, training and qualifications, etc., to Corros Radar, Ltd., Wren Mill, Chadderton, Nr. Oldham, Lancs.

SCIENTIFIC glass-blower required for industrial laboratory engaged in development of wide range of electronic products, cathode ray tubes, photo cells, etc. Experience of bench and lathe work essential, knowledge of hard and soft glass working, glass to metal sealing techniques desirable.—Reply, giving age, experience and wages required, to Cathodene, Ltd., Church St., Cambridge.

TECHNICAL assistant required by well-known company, situated West London district, for investigation of improved processes in cathode ray tube manufacture; degree in chemistry or an equivalent qualification desirable; industrial experience on similar work an asset. Applications, which should include full details of training, experience, age and salary expected, should be addressed to Box 5531. [9238]

PHILIPS ELECTRICAL Ltd., require engineers in the Birmingham and Manchester area to deal with public address equipment and installations; a good standard of technical knowledge and commercial experience in public address or other allied trade is essential; successful applicants must be prepared to reside in London for several months for preliminary training, and possession of a car is essential; write, giving full details as to age, previous experience and salary required, to: Box 5523. [9213]

LONDON publishers require the services of a man possessing a comprehensive knowledge of the radio trade, wholesale and retail, throughout the U.K., to organize and control as sales manager, the advertisement, supply, practical and constructional radio publications through radio dealers to the public; previous experience of publications and special technical knowledge are unnecessary, but it is essential that applicants have a thoroughly up-to-date knowledge of the radio trade; candidates should be known to those experienced in radio accessories; the position is a permanent one and carries remuneration in the form of salary and commission on turnover; age preferably under 45.—Write giving full particulars to Box 5517.

TELEPHONE equipment engineers are required by the Northern Electric Co., Ltd. of Montreal, Canada. Work is preparation detailed specifications for manufacture and installation of automatic exchanges Strowger type, manual and toll switchboards, carrier and repeater equipment; age preferably not over 35 years; applicants should have examination qualifications for Associate Membership I.E.E. and several years' experience of comparable work or alternatively long experience of the work. Salary offered Canadian \$225 to \$325 per month according to qualifications.—Applications should be sent by letter or with full particulars, qualifications and experience, to Messrs. Precedent, Cudew & Rider, 8-10, Queen Anne's Gate, S.W.1.

(A) A senior radio development engineer is required by the South-Western Division of a leading radio company; candidates should have had practical experience in radar work and be capable of controlling sections of coping radar and atomic energy electronic equipment; commencing salary will be £600 upwards according to qualifications and experience, and housing accommodation is likely to be made available in the near future to the person appointed; full details should be submitted immediately.

(B) The Company is also appointing a junior development engineer (inter B.Sc. or equivalent); candidates for this post must have had practical experience in radar and communications equipment design; the commencing salary will be £350-£400 with every prospect and facility for advancement; full details of qualifications and previous experience to be sent in writing.—Box 5542. [9268]

CUT OUT

that 9 K.C. whistle with a Lowther hetrodyne filter. Simply insert it between output transformer and speech coil.

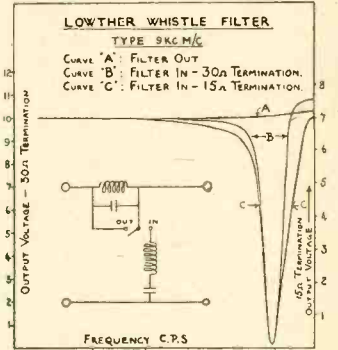

Standard filter designed for 30 ohms, base-board mounted with switch.

3 Gns. plus postage.

Filter for use with speech coils below 15 ohms made to order only.

THE LOWTHER MANUFACTURING CO.
Lowther House, St. Mark's Rd., Bromley, Kent.
Rav. 5225.

American Test Gear

FREQUENCY METERS TYPE BC. 221

Now available, the famous American Frequency Meter. Covering all ranges between 125 Kc/s and 29 Mc/s. Accuracy better than 0.05%. What finer checking medium could you have than this superb piece of test equipment? Crystal checking points on all ranges ensure spot on calibration. Beautifully made and supplied in perfect condition.

Price £15 plus 10/- packing and carriage from: V.E.S. 42 46, WINDMILL HILL, BUSLIP, MIDDX.

NON-MAGNETIC TURNTABLES

with **STROBOSCOPIC MARKING**
An essential accessory for serious **PICK-UP DESIGN RESEARCH**

SOUND SALES LIMITED

57 St. Martin's Lane, London, W.C.2
Temple Bar 4284
Works: Farnham, Surrey

HIGH FIDELITY

We welcome all enthusiasts to our new premises. We carry stocks of Partridge and Varley Transformers and Chokes, matched output valves, matched resistors, high quality loudspeaker, P.U.s., gramophone motors, baffles, Bass Reflex cabinets, and all components for High Fidelity Receivers and Amplifiers. Complete equipments are also available. Our price list is available and we will be glad to send you a copy on receipt of your address and 2/- stamp.

ROGERS DEVELOPMENTS CO.

12, MACCLESFIELD STREET,
SHAFESBURY AVENUE, W.1.
Telephone: GERard 8256.

DRUGHTSMEN required for jig and tool drawing office, must be familiar with electronic equipment construction. Manchester area.—Apply giving full particulars of experience, qualifications and salary required to Box 5547.

EMPLOYMENT engineer required for test, gear and measuring instrument design; some previous experience and suitable technical qualifications essential.—Send full particulars to Taylor Electrical Instruments, Ltd., 419, Montrose Ave., Slough. [9140]

BEILING & LEE, Ltd., have vacancy for Assistant in their research department; applicant must be under 25 years of age, and possess school cert. or equivalent educational qualifications, and must be studying a recognized course, salary according to age and qualifications.—Applications by letter only, giving full details and salary required to 20, Cambridge Arterial Rd., Enfield, Midd. Essex. [9180]

ENGINEERS required for employment on mechanical design of Radar, communication and electronic equipment; applicants must possess a degree in engineering or its equivalent, and be capable of producing designs suitable for small and mass scale production.—Write, stating age, details of experience, training and qualifications, etc., to Cosor Radar, Ltd., Wren Mill, Chedderton, Nr. Oldham, Lancs. [9280]

THE MULLARD ELECTRONIC RESEARCH LABORATORY invites applications for the following posts: (1) For scientists to lead a group working on ultra high radio frequency circuits in close association with valve laboratory and on centimeter wave projects; he should have a good honours degree in physics or electrical engineering or mathematics, at least four years experience in the U.F. field, and be capable of both experimental and theoretical treatment of problems in this field. It is expected that the age of the successful candidate will be between 27 and 35 years and his salary between £650 and £1,000 a year, according to experience and ability. (2) Scientists in both the group mentioned above and other groups working on superconducting electronic measurement and control, television and radio component design. They should have similar academic qualifications to the senior man and preferably some experience of research work. It is expected that the successful candidates will be between 20 and 30 years and their salaries between £350 and £700 a year, according to qualifications.—Applications should be made to the Manager, Mullard Research Laboratories, Salford, Nr. Redhill, Surrey.

SITUATIONS WANTED
YOUNG man seeks position with electronic firm preferably London/Essex area; experience in development projects.—Box 5681. [9343]

EX-R.A.F. Radar filter, etc., age 21, excellent civilian references; seeks position with opportunities in electronic or electrical field, but would like to specialise.—Box 5668. [9327]

RADIO and television engineer, 36, at present employed Mdx. desires work within easy access S.E. London, graduate, qualified musician, interested sales and export.—Box 5519. [9197]

SERVICE eng., long and wide exp with famous manufacturer seeks change of management in high class shop; wife experienced retail radio would help; West Mdd Essex or alternative accommodation.—Box 5684. [9356]

EX-R.A.F. Sgt., wireless mech., 25, good theoretical knowledge radio circuits and fault-finding, seeks practical experience, returns from abroad in preference; then need for experience; London or south preferred.—Box 5537. [9255]

CHIEF draughtsman (39) desires change, 22 years' experience of mechanical design and production drafting of telephone, radio and telecommunication, used to control of staff and operation of modern drawing-office system.—Box 5525. [9220]

EX-R.A.F. officer, 24, radio serviceman, P.M.G. Certificate, previously employed in the radio industry, desires employment, preferably in north, in sound well-established radio business, with opportunity to learn all aspects of the trade.—Write Box 5518. [9190]

RESEARCH engr. and receiver designer, A.M.—Brit. I.R.E. and I.E.E. Asoc. Exam., lecturer for Brit. I.R.E., seeks change giving responsible appointments with progressive company, presents of several receiving circuits, 17 years' prof. experience, good mathematician.—Box 5524. [9217]

TUITION
THE British National Radio School

OFFERS you a career.
WRITE to-day for free booklet describing our wide range of training courses in radio, Radar, telecommunications, principles, mathematics, physics, and mechanics; correspondence and day classes for the new series of C. & G. examinations; we specialise in turning "operators" into "engineers," and for this purpose our "Four Year Plan" (leading to A.M.I.E.E. and A.M.Brit. I.R.E., with 9 C. and G. Certificates as interim rewards) is unsurpassed; "our guarantee has no strings attached."—Studies Director, B.Sc., A.M.I.E.E., M.Brit. I.R.E., 66, Adoniscombe Rd., Croydon, Surrey. [6811]

100 worked examples, advice and notes, invaluable examination practice, set A. for City and Guilds Year One Telecommunication Principles and Practice.—10/-, from Box 5109. [9152]

COMPLETE correspondence course covering amateur and C. & G.1 exams, consisting of 12 lessons, send for particulars.—Everyman's Correspondence College, 72, St. Stephens House, Westminster, S.W.1. [8839]

GALPINS

ELECTRICAL STORES

408 HIGH STREET, LEWISHAM, LONDON, S.E.13

Telephone: Lee Green 0309. Near Lewisham Hospital.

TERMS: CASH WITH ORDER. NO C.O.D.

EX-GOVT. (G.E.C.) ELECTRIC FANS.
 12 volts AC/DC laminated field, complete with 5in. impeller. New boxed 25/- each, 1 1/2 post. Transformer to suit 230 volts input 10/16 volts at 4 amps. output, 32/6 each.

MAINS VARIABLE RESISTANCES.
 Ex-Govt. (new) slider type, 450 ohms to carry 0.7 amps., 33/- each; 4,000 ohms, .25 amps., 35/- each. Worm wheel control slider type, 60 to carry 1 1/2 amps., 27/6 each; 3.7 ohms 8 amps., 32/6 each. Dimmer resistances stud switch arm type, 2,700 ohms to carry .27 amps., 30/- each.

EX-GOVT. (NEW) MAINS TRANSFORMERS.
 200/250 volts 50 cys. 1 ph. input 525/0/525 volts 150 M/amps. 6.3 v. 5 a., 5 v. 3 a. output standard rating, 35/-, post 2/- Mains Smoothing Chokes, 10 Hy. 150 M/amps. 180 ohms D.C. Resistance, 8/6 each. Ditto, 100 M/amps., 5/6 each, post 9d. Smoothing Condensers (oil filled), 4 M.F. 1,000 volt working, 3/6 each. (All the above can be offered in large quantities.) Please write for special quotation.

EX-R.A.F. MICROPHONE TESTERS (new).
 These consist of a FERRANTI 0 to 450 Microamp 2 1/2in. scale meter shunted to 1 M/A incorporated Westinghouse Rectifier, the whole encased in polished teak case calibrated at present 0 to 10 volts, 32/6 each.

EX-R.A.F. POWER UNITS, TYPE 225 (new). Containing the following components: 3-V.U.I.II Rectifier Valves, 1-SU4G2-EB 34s, 3-Multi Contact Relays, High Voltage Condensers, Chokes, Transformers, etc. To clear, 65/- each.

EX-R.A.F. ROTARY CONVERTERS, D.C. to A.C.
 12 volts D.C. to 220 volts 50 cys. 1 ph. A.C. at 100 watts, 85/- each. Ditto, Admiralty Pattern, 110 volts D.C., Input 230 volts A.C. output at 200 watts, £12/10/0 each. C/F Ditto, 220 volts D.C., Input, same output, £15, C/F. Another, 24 volts D.C. input, 50 to 100 volts 50 cys. 1 ph. at 300 watts, £3/15/0 each, C/F.

EX-R.A.F. CRYSTAL CALIBRATORS UNITS. Type 18 R.A.F. serial No. 10a/15237. These units contain 100 Kc/s. xtal 2-EF 50 valves and numerous other items all new and unused, 35/- each.

SPECIAL OFFER METERS, ALL NEW BOXED. Moving Coil First-Grade Instruments, 0 to 20 volts, 10/- each, or 3 for 25/-; 0 to 40 volts, 12/6 each; 0 to 100 amps., 15/- each; all 2in. scale. 0 to 25 volts A.C. calibrated 50 cys., 25/- each; 0 to 4 amps. Thermo Coupled, 25/- each; 0 to 3,500 volts Electastatic, 35/- each, all 2 1/2in. scale.

MAINS TRANSFORMERS (AUTO WOUND). Voltage Changers tapped 10, 20, 25, 90, 130, 150, 190, 210 and 230 volts, all at 1,000 watts, a combination of 34 voltages can be obtained from this Transformer, new ex-Govt. stock, £5/10/- each, carriage 5/- Mains Booster Transformer, tapped 0, 6, 10, 19, 175, 200, 220, 225, 240, and 250 volts at 1,500 watts (new ex-Govt.), £5/5/- each, carriage 5/- Another 200

volts input 240 volts output at 2,500 watts £7/10/-, carriage 7/6. Another, 2 to 1 ratio, 110 volts input 220 volts output or vice versa at 4,000 watts, £12/10/-, carriage 10/- Another, 230 volts input tapped output 40, 41, 42, 44, 46, 47, 49, and 52 volts at 100 amps., £15 each, carriage 10/-; the latter two are double wound. Another auto wound, tapped 0, 110, 150, 190, 210 and 230 volts at 1,500 watts, £6/10/- each, carriage 5/- Ditto, 2,000 watts, £7/5/-, carriage 5/-.

EX-NAVAL CATHODE RAY RECTIFIER UNITS. These units are new and weigh 90lbs. Consisting of high voltage condensers, 15 volume controls, chokes, approx. 100 resistances and condensers all coloured, coded or marked, valve and tube holders (no valves), transformers are included but are for 500 cys., price to clear, 42/6 each, carriage paid.

MAINS TRANSFORMERS, EX-GOVT. All 50 cys. input 230 volts input 500/0/500 volt. at 250 M/amps. L.T. 5 v. 3 a., 37/6, carriage 3/6. Another 50 volts at 30 amps. output, 75/- each, carriage 6/- Another two L.T. windings, 6 1/2 volts at 10 amps., 27/6 each. Another 230 volts input 700 volts at 150 M/amps., 4 v. 2 a., 4 v. 1 a. output, 27/6 each, carriage 3/6. Another 700/0/700 volts 80 m.a., 12 v. 1 a., 4 v. 2 a. output, 30/- each.

EX-R.A.F. IFF UNITS. As new, these units contain 10 valve S.P. 41s, EF 50s, EA 50s, etc., also approx. 100 resistances and condensers, also complete with motor generator, 12 or 24 volts input 450 volts at 50 M/amps. output. To clear, 24-volt type, 35/-; 12-volt type, 42/6, carriage 3/6.

EX-R.A.F. RF UNITS (new) packed, containing 6 valves, all 63 heaters, including grounded grid triode, also a miniature 24-volt motor (universal) and approx. 80 resistances and condensers, all mounted on silver-plated chassis, to clear 45/- each, carriage paid.

L.T. RECTIFIERS (NEW), 12-volts at 1 1/2 amps. output, 10/6 each; 12 volts at 6/8 amps. output, 45/- each. Transformers can also be supplied for charging 6 or 12 volts (delivery 10 days from date of order), prices respectively 25/- and 45/- each.

MAINS TRANSFORMERS (NEW). Input 200/250 volts 50 cys. 1 ph. output 350/0/350 volts at 180 M/amps. 4 v. 4 a. C.T. 6.3 v. 4 a. C.T. 5 v. 3 a., 37/6 each, post 1/6; ditto, 500/0/500 v. 150 m.a. 4 v. 4 a. C.T. 6.3 v. 4 a. C.T. 5 v. 3 a., 47/6 each, post 1/6; another tapped 6, 12 and 24-volts at 10/12 amps., 45/- each, post 1/6. Auto wound Voltage Changer Transformers, tapped 0, 110, 200, 220, and 240 volts 250 watts, 45/-; 350 watts, 55/-; 500 watts, 70/- each, carriage 1/6. (Please note, these Transformers can be delivered 10 days from receipt of order.)

EX-R.A.F. MOTOR GENERATORS. Good condition, 24 volts input D.C., output 450 volts at 50 M/amps., complete with automatic carbon pile resistance, gear box, etc., can also be easily converted to run as motor off A.C. mains, h.p. approx. 1/3 price to clear, 25/- each, carriage paid.

COVENTRY RADIO COMPONENT SPECIALISTS SINCE 1925

Mains Transformers, high grade.
 275-0-275 v. 80 mA, 6.3 v. 3 a., £1 10 0
 5 v. 3 a. £1 10 0
 Ditto, but 350-0-350 sec. £1 10 0
 I.F. Transformers, 465 kc. 15 0

per pair
Stockists of the best makes of all Components for Radio and Television Constructors and Service men. Send for list. Price 3d. Post paid.

PROMPT SERVICE. COMPLETE SATISFACTION

COVENTRY RADIO

191, Unstable Road, Luton
 'Phone: LUTON 2677

MOVING COIL

Hand Microphones (No. 13)



Bakelite case 2 1/2" diam. Preamplifier switch. Soft rubber mouthpiece. Coil 40 ohms d.c. res. Excellent performance. Brand new. In original packing. Including postage, 5/- each, or case of ten for 40/- Despatched same day.

WIRELESS SUPPLIES UNLIMITED

(Props. Unlimitex Radio Ltd.)

264-266, Old Christchurch Road, BOURNEMOUTH, Hants.

WARD ROTARY CONVERTERS

For Radio, Neon Signs, Television, Fluorescent Lighting, X-ray, Cinema Equipment and numerable other applications.

We also manufacture —
Petrol Electric Generating Plants, H.T. Generators, D.C. Motors, etc., up to 25 K.V.A.

CHAS. F. WARD
LORDSCROFT WORKS, HAVERHILL, SUFFOLK
Telephone: Haverhill 253 & 4.

VIBRO-ARC ELECTRIC METAL ENGRAVING TOOL

Engraves, etches, marks
writes... on

- BRASS, COPPER
- SILVER, NICKEL
- ALUMINIUM
- CHROMIUM.
- Hardened Steel

Operates from 4-6 volt
Accumulator or
A.C. Transformer
Order C.O.D. or C.W.O.

Sole Distributors: **BULLS (W)** Retail 15/-
246 High St. Harlesden N.W.10 with full instructions

A.C.S. RADIO

SPECIALISTS IN AMATEUR AND EXPERIMENTAL SHORT-WAVE EQUIPMENT.

Communications Receivers, Televisions High Quality Amplifiers, Speakers, Aerials, Receiving and Transmitting Valves and Meters, etc.

List "W" free on request to—

A.C.S. RADIO, 44, Widmore Rd., BROMLEY Kent. Phone: RAY 0156

THIS Does these

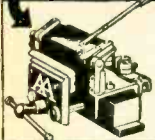

ACCURATELY and QUICKLY
Chassis, Brackets, Shrouds, Condenser and Transformer chisels—
TREPANNING Steel or Aluminium.
Five sizes—12" to 36"
Full particulars from
A. A. TOOLS, (W),
197A, WHITEACRE ROAD
ASHTON-UNDER-LYNE

COIL PICKUP

Heads are available to fit
Record Changer Arms

WILKINS & WRIGHT LTD.
Holyhead Road, Handsworth, B'ham 21.

L-R-S IN STOCK

AVOMETERS

| | | |
|--------------------------------|------------|----------|
| Model 7 | Cash price | £19 10 0 |
| Avominer AC/DO Universal meter | | £8 10 0 |
| Valve tester, complete | | £16 10 0 |
| Avominer DC meter | | £4 4 0 |
| Oscillator, mains | | £13 0 0 |

Please let us have your enquiry for other models

All Avometers available on convenient terms
Morphy Richards Auto Electric Irons. Chrome superb quality 39/6 post 1/-.

Illustrated list of any of the above items 1/-

The LONDON RADIO SUPPLY CO.
(The L.R. Supply Co. Ltd.) Est. 1925
BALCOMBE SUSSEX

ENGINEERING careers and qualifications.

BOTH Government and industry have announced and emphasized that young men with technical knowledge and qualifications must receive every chance to rise to the highest positions within their capacity, in post-war engineering and allied industry; write to-day for "The Engineer's Guide to Success"—200 courses free—which shows you how you can become A.M.I.E.E., A.M.I.A.E., A.M.I.Mech.E., A.P.R.Ae.S., etc., and covers all branches in radio, automobile, mechanical, electrical, production, aeronautical, etc.

THE Technological Institute of Great Britain, 82, Temple Bar House, London, E.C.4. [4918] UNIVERSITY COLLEGE, Southampton.

U diploma in electronics.
AN advanced course of Honours Degree Standard covering the entire field of electronics with special emphasis on receiver design and line technique, will commence at the beginning of October, 1948.

THE course will be full-time for one academic year. The College will grant a diploma by exam. to students who complete the course. Entry qualification is normally a university degree or its equivalent.—Further details may be obtained from the Assistant Registrar.

RADIO training.—P.M.G. exams. and I.E.E. Diploma; prospectus free.—Technical College, Hull. [0611]

POSTAL courses of instruction for amateur radio transmitting licence, P.M.G. Certificates in wireless telegraphy, Ministry of Civil Aviation Certificate, radio engineering and television; also instruction at school.—Apply British School of Telegraphy, Ltd., 79, Clapham Rd., London, S.W.9 (Est'd. 40 years).

"ENGINEERING opportunities."—Have you A.M.I.Mech.E., A.M.I.E.E., and all branches of engineering, building and plastics? Become technically trained on "no pass—no fee" terms for higher pay and security.—For free copy write B.I.E.T. (Dept. 387B), 17, Stratford Place, London, W.1. [6939]

THE RADIO ENGINEERING SCHOOL, air service training, Hamble, Southampton, offers full-time residential training for radio engineers seeking responsible positions in industry or civil aviation; students are coached for C and G telecommunications or Brit. I.R.E. exams. as preferred; tuition also available to M.C.A. requirements in radio and radar.—For full details apply to the Commandant. [9265]

THE Institute of Practical Radio Engineers have available Home Study Course covering elementary, theoretical, mathematical, practical and laboratory tuition in radio and television engineering; the text is suitable coaching matter for I.P.R.E. Service entry and progressive exams.; tuition fees at pre-war rates—are moderate. The Syllabus of Instruction and Text may be obtained, post free, from the Secretary, 20, Airfield Rd., Crouch End, N.8. [6722]

AGENTS WANTED

MANUFACTURERS require representatives throughout the U.K. to market their special moving coil pick-ups and other specialities.—Write to Box 4468. [8866]

TECHNICAL TRAINING

A.M.I.E.E., City of Guilds, etc., on "No Pass—No Fee" terms; over 95% successes; for full details of modern courses in all branches of electrical technology send for our 112-page handbook, free and post free.—B.I.E.T. (Dept. 388A), 17, Stratford Place, London, W.1. [6270]

BOOKS, INSTRUCTIONS, ETC.

R.S.G.B. technical publications.—The following are of special interest to transmitting amateurs and short-wave enthusiasts:—

"MICROWAVE Technique."—An up-to-date treatise on a subject of vital interest, 68 pages, 2/3, post free.

"SERVICE Valve Equivalents."—Lists commercial equivalents of many hundreds of Service and CV types. 28 pages, 1/-, post free.

"THE Transmitting Licence."—How to obtain an amateur licence. 32 pages, 1/-, post free.

"RADIO Handbook Supplement," 4th edition. Radio mathematics, D/F, C.R. tubes, etc., etc. 168 pages, 2/9, post free.

"R.S.G.B. Bulletin."—Monthly pub. of the R.S.G.B. 1/6 post free. (Free to members.) RADIO Society of Great Britain, 28, Little Russell St., London, W.C.1.

WEBB'S radio map of the world locates any station heard, size 40x30in, 4/6, post 6d.; on liner, 10/6, post free.—Webb's Radio, 1-4, Soho St., W.1, Gerrard 2069. [9947]

FINANCIAL PARTNERSHIP

WANTED, active interest in sound Relay P.A. cinema or factor's business; £1,000 to £2,000 interest.—Box 5544. [9273]

TRANSFORMERS & COILS TO SPECIFICATION.

MANUFACTURED OR REWOUND.
Filter Coils a Speciality.

JOHN FACTOR LTD.

9-11 EAST STREET, TORQUAY, DEVON.
Phone: Torquay 2162

FIFTH SALE.



By Order of the Minister of Supply.

Without Reserve.
STAVERTON, GLOS.

Sub-site of No. 7 Maintenance Unit, R.A.F. on the main Gloucester-Cheltenham Road, about 4½ miles from each.

A Large Quantity of
SURPLUS AMERICAN RADIO & ELECTRICAL EQUIPMENT.

comprising:

Receivers, Modulator Units, Amplifiers, Rectifiers, Loudspeakers, Motor Generators, Dynamotors, Voltage Control Units, Transformers, Condensers, Switches, Sockets and extensive quantities of other radio spares.

To be Sold by Auction on

FRIDAY, MARCH 5th, 1948,

at 11 o'clock punctually by

J PEARCE POPE & SONS.

View Days: Mon. Tues., Wed. and Thurs. March 1st, 2nd, 3rd and 4th, from 10 a.m. to 4 p.m., and on day of Sale from 9 a.m. to 11 a.m.

Catalogues, price 6d. each (postal orders only), may be had from the Auctioneers, St. Aldate Chambers, Gloucester. Tel. 2274 (two lines).

ADMISSION WILL BE BY CATALOGUE ONLY.

TRANSFORMERS & CHOKES

High Quality Vacuum Impregnated

AUSTIN MILLS LTD.

LOWER CARRS STOCKPORT

Telephone: STO. 3791 Established 20 years.

PHOTO-ELECTRIC CELLS

for

Talking Picture Apparatus.

Catalogue now available

RADIO-ELECTRONICS LTD.,

St. George's Works, South Norwood, London, S.E. 25.

Beethoven ROTARY CONVERTORS

220 C.C. to 220 A.C.

Details from—

BEETHOVEN ELECTRIC EQUIPMENT LTD.
Beethoven Works, Chase Road, London, N.W.10

WE OFFER

A large range of used and new Test Equipment, Converters, Recorders, Amplifiers, Motors, Transformers, etc.

All guaranteed and at very attractive prices.

Try us first and buy more gear for less money.

UNIVERSITY RADIO LTD.

22 LISLE STREET, LONDON, W.C.2.

Tel.: GER 8582 & 4447.